



## **Hi - Lo**

High -Tech Design to enhance Low - Tech execution

**Siddharth Jadhav**

A thesis submitted in partial fulfillment of the requirements for the degree of  
Master of Science in Architecture

University of Washington

2015

Thesis Committee :

Brian R. Johnson

Rob Corser

Kimo Griggs

Program Authorized to Offer Degree : Architecture

© Copyright 2015

Siddharth Jadhav

University of Washington

**Abstract**

Hi-Lo : High -Tech Design to enhance Low - Tech execution

Siddharth Jadhav

Chair of the Supervisory Committee:

Brian R. Johnson

Department of Architecture

Variation, in the form of patterns in space and time, is fundamental to architecture, but produces complexity in design and construction processes. This complexity is usually managed by constraining variability within a limited palette of choices. By enhancing our ability to manage much more complexity, computers invite greater variation in design. Improved analysis tools enable us to predict performance of complex geometries. Generative algorithms and parametric design tools produce systematic variation. Finally, computer numerically controlled (CNC) machines facilitate the production of variation generated by high-tech performance based generative design tools. But, CNC machines are not globally accessible. At the same time, low-tech production methodologies do offer possibilities for producing variation. This thesis proposes and examines a combination of high-tech performance based generative design tools and low-tech production techniques for use in contexts where CNC machines are not accessible.

## Acknowledgments

I thank my thesis committee for being extremely supportive, and encouraging me throughout the process. The process of exploration would not have been so engaging without their guidance. It has been a pleasure working with Prof. Brian R. Johnson, Prof. Rob Corser and Prof. Kimo Griggs.

A special vote of thanks to all my DMG mates and the CBE community at large for providing support and helping me out unconditionally.

I thank all my teachers for blessing me in multiple ways during this exciting journey of learning.

**This research is dedicated to the developing world.**

# Table of Contents

<b>Titles</b>	<b>Page numbers</b>
Table of figures	8
Introduction	10
Motivation	11
Case Studies : Modular {Pre - Fab}	12
Case Studies : Modular {Pre - Cast}	14
Case Studies : Performance based generative design	16
Case Studies : Low-tech construction	18
Case Studies : Static shading devices	29
Case Studies : Observations	33
Thesis statement	35
Project goals	36
Project mechanism	37
Project diagram	38
Hi - tech design : parametric modeling	40
Lo - tech production : casting {prototyping}	43
Hi - tech design : solar analysis	48

## Table of Contents

<b>Titles</b>	<b>Page numbers</b>
Lo - tech production : strategies	77
Conclusion	94
Future directions	97
References	98
Web references	100

## Table of figures

<b>Figures</b>	<b>Source</b>
fig. 10a	<a href="http://mafana.files.wordpress.com/2011/10/2-0002.jpg">http://mafana.files.wordpress.com/2011/10/2-0002.jpg</a>
fig. 12a	<a href="http://inhabitat.com/prefab-friday-living-homes-kieran-timberlake-las-vegas/attachment/18846/">http://inhabitat.com/prefab-friday-living-homes-kieran-timberlake-las-vegas/attachment/18846/</a>
fig. 13a	<a href="http://iaac-digitalarchitecture.blogspot.com/2007/12/mit-instant-house-project.html">http://iaac-digitalarchitecture.blogspot.com/2007/12/mit-instant-house-project.html</a>
fig. 14a	<a href="https://www.academia.edu/2964517/Reverse_Layered_Manufacturing_for_Moldable_Composites_using_CAD_CAM_Technologies">https://www.academia.edu/2964517/Reverse_Layered_Manufacturing_for_Moldable_Composites_using_CAD_CAM_Technologies</a>
fig. 14b	
fig. 15a	<a href="http://modularvariations.files.wordpress.com/2013/02/andrew-kudless-p-wall.pdf">http://modularvariations.files.wordpress.com/2013/02/andrew-kudless-p-wall.pdf</a>
fig. 15b	
fig. 15c	
fig. 16a	<a href="http://wroad.net/wordpress/?p=1">http://wroad.net/wordpress/?p=1</a>
fig. 17a	Kolarevic, B., Malkawi, A. (ed), Performative Architecture, Spon Press New York and London, Pg. 211
fig. 18a	<a href="http://www.earth-auroville.com/world_techniques_introduction_en.php">http://www.earth-auroville.com/world_techniques_introduction_en.php</a>
fig. 19a	<a href="http://www.earthhomes.net/castearth.html">http://www.earthhomes.net/castearth.html</a>
fig. 20a	<a href="http://www.ebay.com/itm/1962-Colombia-Cinva-Ram-Block-Making-Machine-for-New-Village-Center-Press-Photo-/400718392703">http://www.ebay.com/itm/1962-Colombia-Cinva-Ram-Block-Making-Machine-for-New-Village-Center-Press-Photo-/400718392703</a>
fig. 21a	<a href="http://www.earth-auroville.com/auram_earth_equipment_introduction_en.php">http://www.earth-auroville.com/auram_earth_equipment_introduction_en.php</a>
fig. 21b	
fig. 22a	<a href="http://www.nzdl.org/gsdImod?e=d-00000-00---off-0hdl--00-0----0-10-0---0---0direct-10---4-----0-1l--11-en-50---20-help---00-0-1-00-0-0-11-1-0utfZz-8-00&amp;a=d&amp;cl=CL3.21&amp;d=HASH4edbf917bee4e6ae86aa2c.23">http://www.nzdl.org/gsdImod?e=d-00000-00---off-0hdl--00-0----0-10-0---0---0direct-10---4-----0-1l--11-en-50---20-help---00-0-1-00-0-0-11-1-0utfZz-8-00&amp;a=d&amp;cl=CL3.21&amp;d=HASH4edbf917bee4e6ae86aa2c.23</a>
fig. 23a	<a href="http://www.earth-auroville.com/various_auram_equipment_en.php">http://www.earth-auroville.com/various_auram_equipment_en.php</a>
fig. 24a	<a href="http://www.starship-enterprises.net/files/village-level%20brickmaking.pdf">http://www.starship-enterprises.net/files/village-level%20brickmaking.pdf</a>
fig. 24b	
fig. 25a	<a href="http://research.history.org/Coffeehouse/Blog/index.cfm/2008/9/20/Making-bricks-at-the-brickyard">http://research.history.org/Coffeehouse/Blog/index.cfm/2008/9/20/Making-bricks-at-the-brickyard</a>
fig. 26a	<a href="http://www.formblock.com.au/what_is_formblock.htm">http://www.formblock.com.au/what_is_formblock.htm</a>

<b>Figures</b>	<b>Source</b>
fig. 27a	<a href="http://www.formblock.com.au/what_is_formblock.htm">http://www.formblock.com.au/what_is_formblock.htm</a>
fig. 28a	Ledderose, L., Ten Thousand Things : Module and Mass Production in Chinese Art
fig. 28b	<a href="http://www.npm.gov.tw/exh95/rarebooks/html/en/knowing.html">http://www.npm.gov.tw/exh95/rarebooks/html/en/knowing.html</a>
fig. 29a	<a href="http://theahmedabadblog.com/petition-ahmedabad-jaali.html">http://theahmedabadblog.com/petition-ahmedabad-jaali.html</a>
fig. 29b	<a href="http://kanwalkwilltravel.com/2014/07/03/poetry-at-fatehpur-sikri/">http://kanwalkwilltravel.com/2014/07/03/poetry-at-fatehpur-sikri/</a>
fig. 30a	<a href="http://en.wikipedia.org/wiki/Palace_of_Assembly_(Chandigarh)#mediaviewer/File:Palace_of_Assembly_Chandigarh_2006.jpg">http://en.wikipedia.org/wiki/Palace_of_Assembly_(Chandigarh)#mediaviewer/File:Palace_of_Assembly_Chandigarh_2006.jpg</a>
fig. 30b	<a href="http://studioackt.blogspot.com/2010/05/mill-owners-house-in-ahmedabad-by.html">http://studioackt.blogspot.com/2010/05/mill-owners-house-in-ahmedabad-by.html</a>
fig. 30c	<a href="http://www.campoamor-photography.com/#/india/ahmedabad/Ahmedabad_Gujarat_India_Campoamor_Architects_15">http://www.campoamor-photography.com/#/india/ahmedabad/Ahmedabad_Gujarat_India_Campoamor_Architects_15</a>
fig. 31a	<a href="http://www.naturalbuildingblog.com/glassless-windows/">http://www.naturalbuildingblog.com/glassless-windows/</a>
fig. 31b	<a href="http://www.bdonline.co.uk/laurie-baker-guru-of-low-cost-housing/3084818.article">http://www.bdonline.co.uk/laurie-baker-guru-of-low-cost-housing/3084818.article</a>
fig. 31c	<a href="http://jpgmag.com/photos/3230242">http://jpgmag.com/photos/3230242</a>
fig. 31d	<a href="http://jpgmag.com/photos/3230242">http://jpgmag.com/photos/3230242</a>
fig. 32a	<a href="http://www.thehindu.com/features/homes-and-gardens/building-with-jaali-walls/article1133562.ece">http://www.thehindu.com/features/homes-and-gardens/building-with-jaali-walls/article1133562.ece</a> <a href="http://www.thehindu.com/todays-paper/tp-features/tp-propertyplus/the-multifunctional-jaali/article1138372.ece">http://www.thehindu.com/todays-paper/tp-features/tp-propertyplus/the-multifunctional-jaali/article1138372.ece</a>
fig. 34a	
fig. 36a	
fig. 37a	
fig. 39a	
fig. 40a	Crawford, S., An Architecture of Relationships Built on the Use of Parametric Modeling and Evaluative Analysis in Design, M.Arch thesis, 2008
fig. 41a	
fig. 41b	
fig. 41c	

## Table of figures

<b>Figures</b>	<b>Source</b>
----------------	---------------

fig. 42a	
----------	--

fig. 42b	
----------	--

fig. 44a	
----------	--

fig. 45a	
----------	--

fig. 45b	
----------	--

fig. 45c	
----------	--

fig. 45d	
----------	--

fig. 46a	
----------	--

fig. 48a	
----------	--

fig. 49a	
----------	--

fig. 49b	
----------	--

fig. 49c	
----------	--

fig. 50a	
----------	--

fig. 50b	
----------	--

fig. 50c	
----------	--

fig. 51a	
----------	--

fig. 51b	
----------	--

fig. 51c	
----------	--

fig. 52a	
----------	--

fig. 52b	
----------	--

fig. 52c	
----------	--

fig. 53a	
----------	--

**9.1**

<b>Figures</b>	<b>Source</b>
----------------	---------------

fig. 53b	
----------	--

fig. 53c	
----------	--

fig. 54a	
----------	--

fig. 54b	
----------	--

fig. 54c	
----------	--

fig. 56a	
----------	--

fig. 57a	
----------	--

fig. 58a	
----------	--

fig. 59a	
----------	--

fig. 60a	
----------	--

fig. 61a	
----------	--

fig. 62a	
----------	--

fig. 63a	
----------	--

fig. 64a	
----------	--

fig. 65a	
----------	--

fig. 66a	
----------	--

fig. 67a	
----------	--

fig. 68a	
----------	--

fig. 69a	
----------	--

fig. 70a	
----------	--

fig. 71a	
----------	--

fig. 72a	
----------	--

## Table of figures

<b>Figures</b>	<b>Source</b>
fig. 73a	
fig. 74a	
fig. 75a	
fig. 79a	
fig. 80a	
fig. 81a	
fig. 82a	
fig. 83a	
fig. 84a	
fig. 85a	
fig. 86a	
fig. 87a	
fig. 88a	<a href="http://bloquera-ceta-ram.blogspot.com/2012/09/manual-ceta-ram-en-pdf.html">http://bloquera-ceta-ram.blogspot.com/2012/09/manual-ceta-ram-en-pdf.html</a>
fig. 90a	
fig. 91a	
fig. 91b	
fig. 92a	
fig. 92b	
fig. 93a	
fig. 94a	
fig. 95a	

# Introduction

The realm of architecture, since the introduction of transfer-technologies [Kieran, Timberlake, 2004], has been in a constant state of flux. Numerical control has pushed architects to re-think architecture at multiple levels at every stage of design and construction [Moe, 2010].

The practice of architecture can now be viewed as a combination of 'making' and 're-making' [Massie, 2010] [fig. 4a]. Geometric forms are first made (formed) in the digital world of bits and then re-made (constructed) in the physical world of atoms through a seamless system of information transfer. The couple of computer aided design (CAD) and computer aided manufacturing (CAM) has pushed the boundaries of digital and physical formulation.

However, it becomes essential to understand the context specificity of these technologies. Tools and processes originally developed for the manufacturing industries may not be easily accessible or appropriately utilized in developing regions of the world for building construction. The real challenge in such scenarios lies in identifying a solution space that offers a contextual response not only in terms of design but also production, taking in to account the resources available. Hi-Lo aims at identifying a solution space that lies at the intersection of high-tech design and low-tech production.

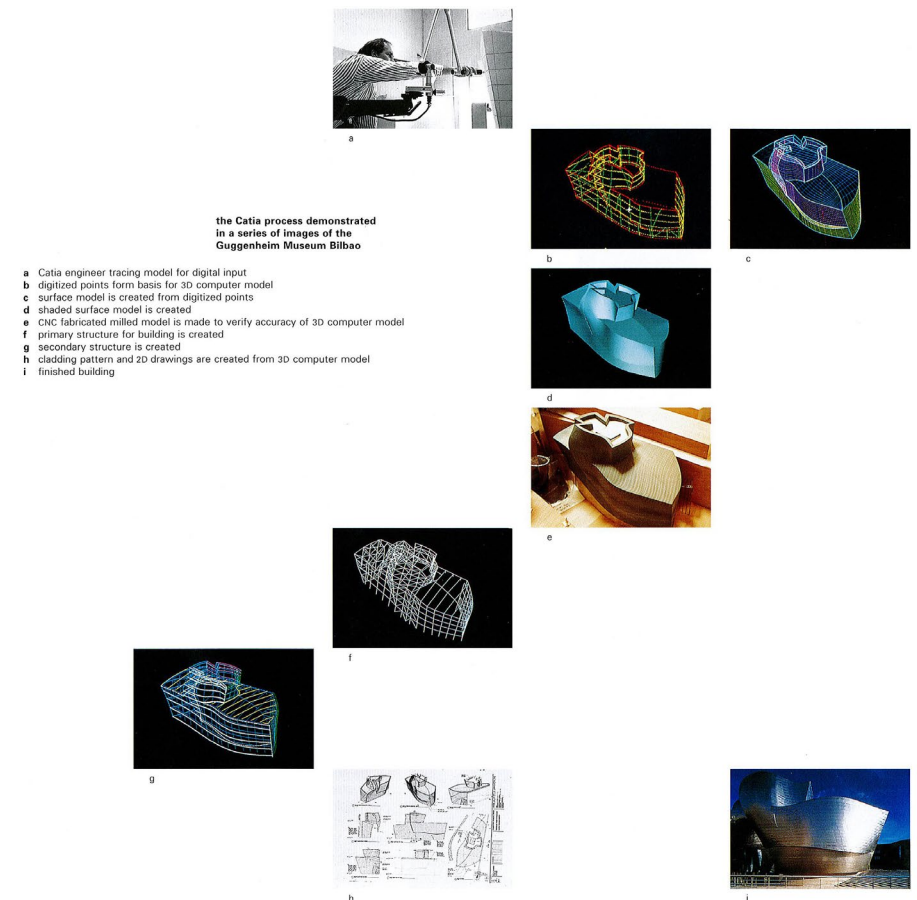

[fig. 10a] Process images, Guggenheim Museum, Bilbao; Gehry Partners, LLP

Hi-Lo was born out of the polarity that evolved after witnessing the potentials of computational process related to ‘making and ‘remaking’ as a graduate student in the United States, and the experience of understanding the realities of (low-tech) building construction while practicing architecture in India.

Developing design and production strategies integrating CAD and CAM tools has become common practice in the field of architecture. The experience of being personally involved in such processes has been quite engaging and satisfying. But, it was difficult to remain detached from the fact that computer numerically controlled (CNC) tools are not easily accessible in developing parts of the world. And therefore, developing complex forms (and assemblies) without integrating digital fabrication strategies seemed impossible.

The greater challenge, then, was to evolve a system that enhances low-tech execution by integrating high-tech computational design tools. It became imperative to manifest this challenge in the form of a project.

Arch 485 (Spring 2014), a digital design & fabrication course taught by Prof. Rob Corser at the College of Built Environments (CBE), University of Washington, offered an opportunity to formulate a project based on this idea. Grasshopper [URL 12], a generative modeling plug-in for Rhinoceros 5.0 [URL 16] was used as a high-tech design

tool to generate variation and casting was used as a low-tech indirect manufacturing methodology. The project was developed through a bottom-up evolution. A bottom-up design process starts with a detailed resolution of modularity by weaving issues of structure, materiality, fabrication, infrastructure, and so forth in a way where each contributes toward effect.

This research project aims at investigating the degree of customization offered by digital tools in a low-tech manufacturing environment .

## Case Studies : Modular {Pre - fab}

Pre-fabricated architecture [fig. 12a] falls within the umbrella of a bottom-up process. Predesigned parts/components can be fabricated off-site and their assemblies can be re-configured based on site and programmatic conditions. Architects Stephen Kieran and James Timberlake, with a heavy influence of the efficiency observed in the manufacturing of automobiles and airplanes, promote this concept as a kit-of-parts approach [Kieran, Timberlake, 2004].

Modularity in that sense comes with massive cost implications. The cost associated with shipping standardized raw material to a factory for pre-fabrication and storing it in a warehouse until it is shipped to a construction site for assembly, increases the overall project cost manifold. Flatpack house [URL 1] is one such venture that offers unique home design solutions using their catalogue of modular components. Their services cost around \$200-300 per square foot [URL 1] and may increase based on the degree of customization required by local or building codes. Whereas, the cost of construction for a standard home is around \$120 per square foot [URL 2].

Professor Larry Sass at MIT, through his research, has proposed a similar model for disaster management housing [Sass, Botha, 2006]. His research project aimed at developing a modular housing unit taking cultural aspects of that region into consideration. The solution was to design a house as a jigsaw puzzle of parts that could be

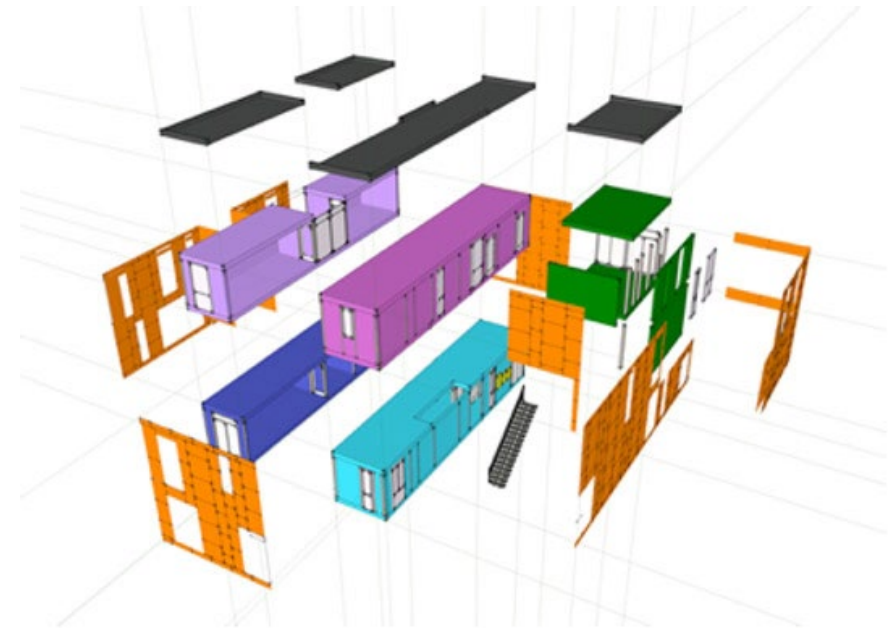

[fig. 12a] KT 1.5

CNC cut from standard 4'x8' sheets of plywood [fig. 13a]. The concept is quite unique as it encourages generative design ideas and evaluates iterations based on the feasibility of fabrication. The project was developed as an outreach program by MIT's Center for Bits and Atoms [URL 3]. But, plywood may not be a cheap resource and a suitable material for construction in most parts of the world.

Alistair Parvin, a British architect, has gained popularity for his venture 'Wikihouse' [URL 4]. 'Wikihouse' is a novel concept,

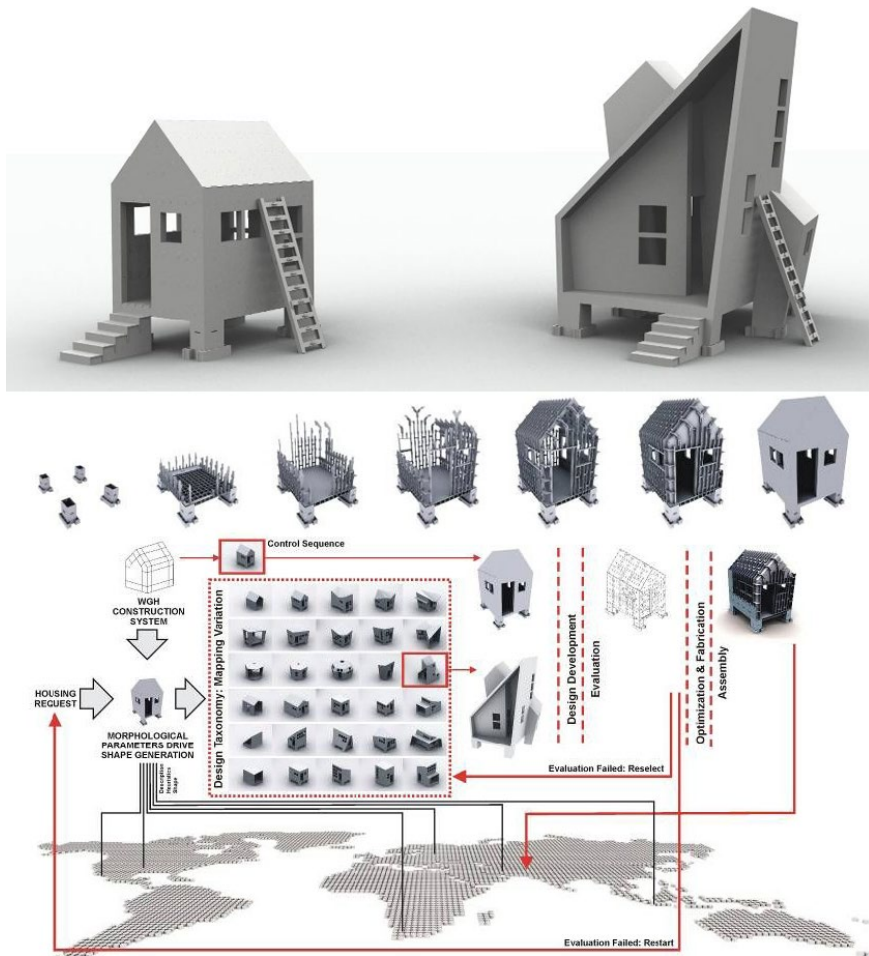

[fig. 13a] INSTANT HOUSE

based on the idea of co-design, a form of adaptive mass-customization. Adaptive customization, as identified by Gilmore and Pine [URL 5], is a type of customization, where one standard but customizable product is designed so that users can alter it themselves within a limited range defined by the manufacturer. Wikihouse started with enabling end-users to design their homes on a web-based system that utilized Sketchup [URL 6] as a modeling platform. Their business model has now changed and offers limited services. Google has very recently partnered with Parvin to propel the venture. Like Sass's project, Wikihouse proposes the use of off-the-shelf material (4' x 8' sheets of plywood) and operates on the assumption that CNC mills are easily accessible.

Rather than CNC fabricating an entire building, a good alternative could be a combination of existing construction techniques and computationally customized components. Component customization as seen in InterLattice (Johnson, 2011) allows generating an interlocking lattice geometry (slot and tab connection) using a generative modeling tool. The size of each member in this system remains consistent, but the slots and tabs are unique to their position. The members can be nested and CNC cut out of sheets of plywood. The system is structurally stable and uses less material. The product is proposed to be used as interior walls, self-supporting awnings and as a part of weatherproofed exterior structures.

## Case Studies : Modular {Pre - cast}

Researchers from the Digital Design Fabrication Group [URL 7] at MIT [Griffith et al., 2012] proposed an interesting solution through one of their research projects. Instead of using sheet material for construction, a casting mechanism was developed using sheet material for repeatable production of interlocking masonry blocks [fig. 14a]. The solution was proposed for shanty towns in South Africa where resources are scanty. The mold was designed to cast moldable composites, and concrete was used for conducting tests. The model was based on coupling high-tech design and low-tech construction. Building units were parametrized via scripting in a digital environment and were fabricated using a laminated object manufacturing approach (LOM). Casting was identified as a low-tech construction method but the molds were fabricated using laser cutting and CNC milling. The proposition involved on-site fabrication via CNC tools enabled by the digitally scripted design tool [fig. 14b]. Customization, here, is introduced at the design level by developing a tool that allows the fabrication of unique components. Such a process can very well be categorized as a bottom-up process.

The P-Wall [fig. 15a] project by educator and artist Andrew Kudless [URL 8] aimed at generating modular variations through casting hydrocal in molds made out of spandex lycra laid over wooden dowels, fitted within a larger solid mold [fig. 15b]. The elastic expansion of spandex responded to the change location of dowels and produced



[fig. 14a]

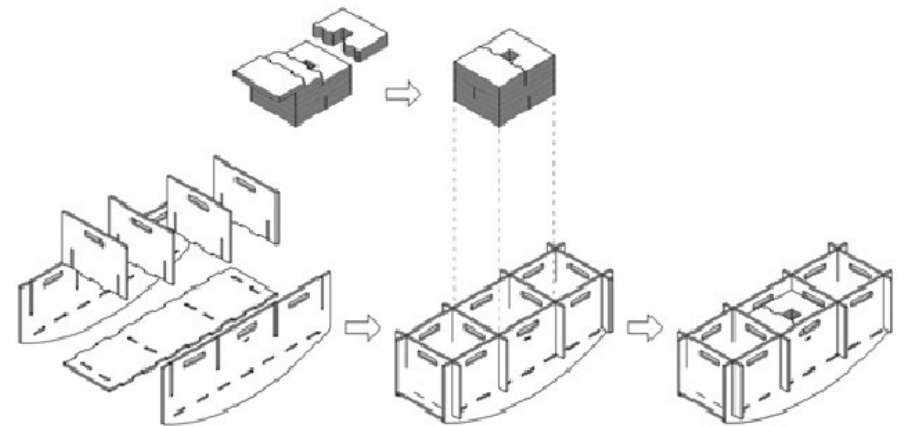

[fig. 14b]



[fig. 15a] P-Wall



[fig. 15b]

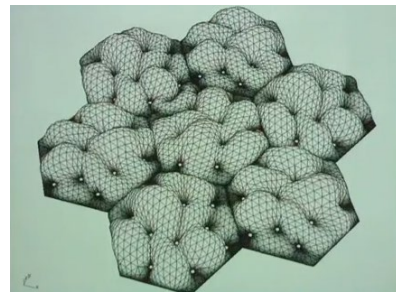

[fig. 15c]

variation is the cast pieces. Variation in this system was purely governed by the fabrication system. In later versions, Kudless used Rhinoscript to generate variation. The geometry was rationalized by generating eight variations digitally and fabricated pieces using the same fabrication methodology. The location of dowels was informed by the generative tool (Rhinoscript). The tool was not only used for generating modules with variation in the digital environment but was also used to extract information for low-tech fabrication. The eight variations were fabricated in calculated multiples and were arranged strategically as an assembly that appears as an installation comprising of unique pieces [fig. 15c]. Variation, in this case, was generated purely for aesthetic reasons. The system, is again an example of a bottom-up process and portrays a combination of high-tech design and low-tech production. However, it is important to observe that the process of information transfer from high-tech to low-tech environments is not seamless and therefore needs to be carefully addressed to achieve desired results.

Parameters that drive a bottom-up design process are the varying change of a form's mass or the components that define it such as size and geometry. Size can address depth, height, and width while geometry can define surface shape, cross section, or even voids. Integrating a varying thickness in cross section is something that is best captured by casting an object as displayed in the project described above.

## Case Studies : Performance based generative design

The logic that drives bottom-up processes is comparable to genetic mechanisms. Information embedded in a set of genes (modular chunks) will largely influence the phenotypical characteristics of an organism. And, is greatly responsible for exhibiting variation in successive generations through recombination.

Parametric modeling has been greatly instrumental in establishing workflows related to performance analysis and digital fabrication due to its rapid adaptability to changing input and its ability to deliver precise geometric data [Kolarevic, Malkawi, 2005].

An interesting project by Esmaili (2014) utilizes a bottom up design logic coupled with performance based generative modeling. She proposes the use of Grasshopper as a parametric modeling tool to generate brick screens (solar shading devices) which can be simultaneously analyzed for their environmental performance through Ladybug (a plug-in that connects Grasshopper with Diva). The assembly patterns are customizable based on program and site conditions.

eifForm, a software developed by Kristina Shea for structural optimization is based on a parametric modeling platform and utilizes a stochastic, non-monotonic algorithm called “simulated annealing” [Kolarevic, Malkawi, 2005]. The software develops the overall form of a structure dynamically in a time based fashion by repeatedly



[fig. 16a] Experimental structure, designed by Kristina Shea et al., erected in Amsterdam in 2002

modifying an initial design with the aim of reaching a goal state by improving performance through satisfying predefined objectives such as structural efficiency, economy of materials, member uniformity, economy of materials and such [fig. 16a].

Form finding techniques used in the design of tensile structures pioneered by Frei Otto could be considered as the nearest ex-

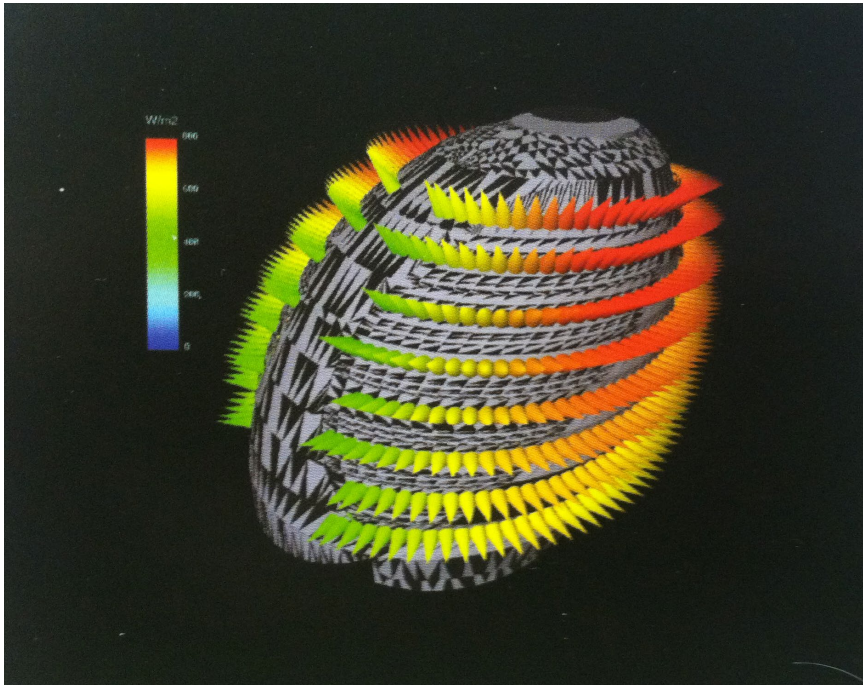

[fig. 17a] Solar diagram for the City Hall building, London

ample of performance driven architectural form generation, prior to the introduction of generative tools, in which the form of the membrane is dynamically affected by changing the forces that act on the model [Kolarevic, Malkawi, 2005].

Generative tools based on performance evaluation are being increasingly used for form-finding processes in architecture. In

such a process an already structured building typology, with a generic form, could be subjected to dynamic metamorphic transformation resulting from the computation of performance targets set in the early stages.

The City Hall building designed by Foster and Partners has an iconic biomorphic form which portrays a logic of environmental performance. The “pebble-like” form resulted from the optimization of its energy performance by minimizing the surface area exposed to direct sunlight [Kolarevic, Malkawi, 2005]. The deformed sphere has a 25% smaller surface area than a cube of identical volume, resulting in reduced solar heat gain and loss through the building’s skin.

Performance optimization through evolutionary computing is a territory commonly explored in the realm of engineering. Its introduction to architecture has resulted in the some high performance buildings/assemblies.

## Case Studies : Low-tech Construction

For centuries, vernacular architectural traditions have proved to be sustainable, and are still being followed in most parts of the world. Forty percent of the world population lives in earthen dwellings. Earthen architecture falls within the umbrella of sustainable development. The attempt to sustainable development is to integrate an alternative building process, various appropriate building technologies and renewable energy sources.

Soil, an abundant natural resource, when mixed with cement and aggregate in the right proportions can be used as a building material. This mix is used for cast-earth construction and preparing concrete stabilized earth blocks to be used as building units.

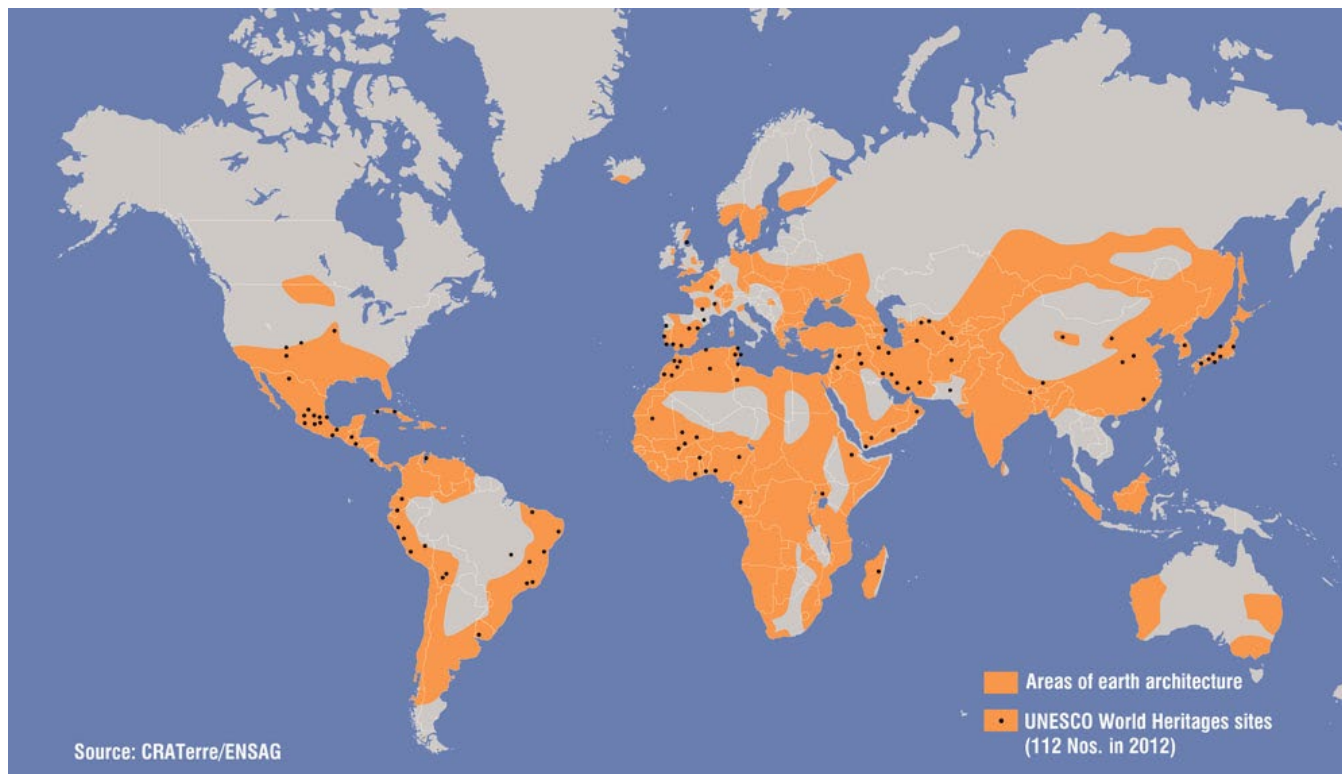

[fig. 18a]

## Case Studies : Low-tech Construction

### Cast earth construction

Cast Earth is a proprietary modified building material developed since the mid-1990s by Harris Lowenhaupt and Michael Frerking based on the earlier Turkish Alker, which is a concrete-like composite with soil of a suitable composition as its bulk component stabilized with about 15% calcined gypsum (plaster of Paris) instead of Portland cement. It can be used to form solid walls that need not be reinforced with a steel frame or timber framing, unless extra seismic reinforcement is necessary. Forms are set up and filled with Cast Earth, which sets quickly and solidly. Once the forms are removed the wall stays sound.

The calcined gypsum sets quickly, which is one quality that has historically made plaster of Paris so useful. Cast Earth uses another retardant for an even greater working time. When the material is dry, it is similar to adobe in various ways, outperforming it in tensile strength, hardness, and erosion resistance. It also has less tendency to crack and shrink. Cast Earth walls do soak up water, however, if they are not sealed with a silicone coating or other waterproofer. It is often less costly, since earth and calcined gypsum are plentiful and cheap materials to acquire.

Few contractors are licensed in the use of Cast Earth today, but if public demand for structures made of the material grows, more builders will seek training in its use



[fig. 19a]

## Case Studies : Low-tech Construction

### Compressed stabilized earth blocks

CINVA RAM {manual block making machine}

Inventor : Raul Ramirez

Year : 1952

Location : Inter-American Housing Center (CINVA), Bogota, Colombia



[fig. 20a]

## Case Studies : Low-tech Construction

### Compressed stabilized earth blocks

Compressed Stabilized Earth Block (CSEB) technology is used worldwide because it represents a synthesis between traditional practices and a modern technology.

The Auroville Earth Institute (India) has designed manual presses for CSEB, the Auram [fig. 22a], which are manufactured in Auroville by Aureka, one of its steel workshops. Today, the press 3000 for compressed stabilized earth blocks is being sold in Asia, Africa, USA, Middle East and Europe.

In Auroville, CSEB are stabilized with 5% cement and have an average dry compressive crushing strength of 50 kg/cm<sup>2</sup> (5 Mpa) and a wet compressive crushing strength of 25 kg/cm<sup>2</sup>. The water absorption is around 10%.

The AURAM press is a fairly low-tech equipment and can accommodate seventy different kinds of molds to create different combinations of interlocking blocks. AURAM makes customization possible at the component level and at the assembly level. Permutations can be generated based on the possibility of interlocking these blocks to create desired geometries [URL 9]. This press is an improvised version of the CINVA ram which was developed by Raul Ramirez at the Inter-American Housing Center (CINVA) in 1956 [URL 19].



[fig. 21a]



[fig. 21b]

## Compressed stabilized earth blocks

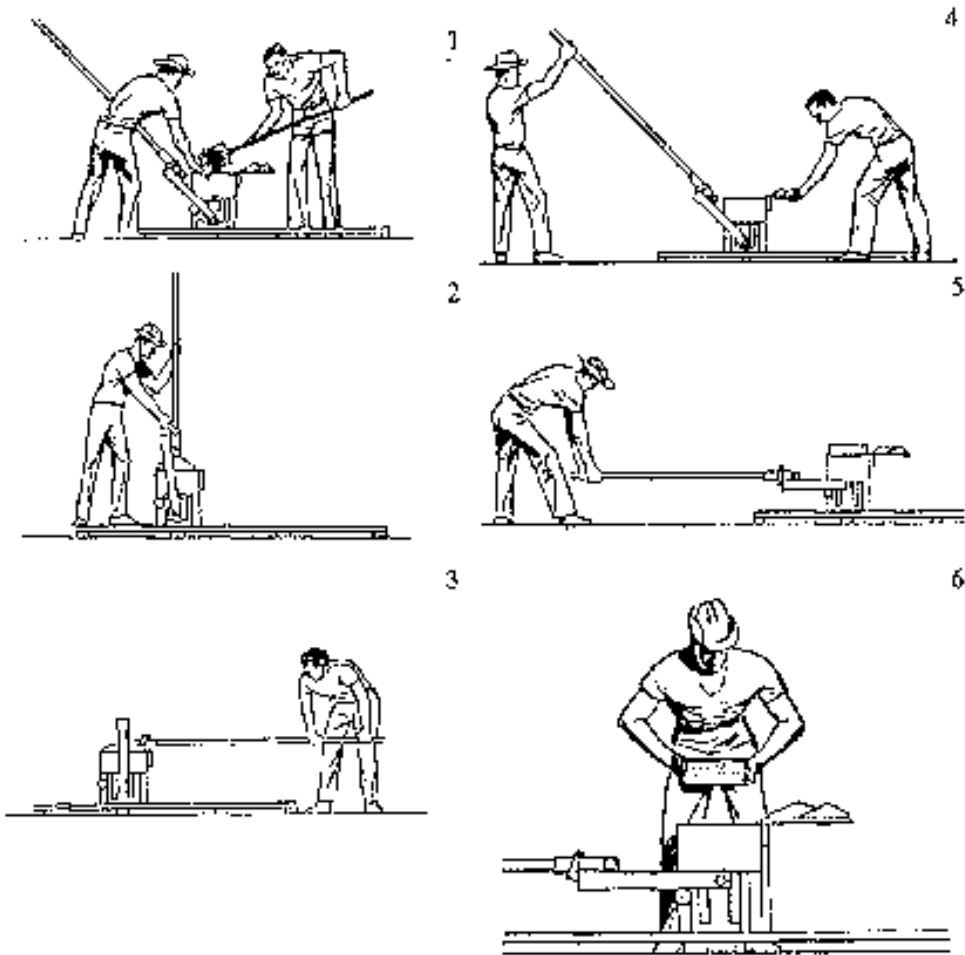

[fig. 22a]

It is the oldest, truly low-cost, portable soil block press, and numerous manual presses produced in different parts of the world are based on the design and working principle of this machine.

### Operating the CINVA-Ram

In the vertical position, the lever arm is fixed to the yoke by means of a latch. These are pulled back together and the mold cover swung open. After greasing the sides of the mold, the soil mix is filled in, making sure that the corners are properly filled and slightly compressed by hand. When swinging back the mold cover the surplus soil is removed.

The lever is brought back to the vertical position and the latch released. The lever arm is then pulled down on the side opposite to its previous position, to compress the block. When the block is fully compacted, the lever arm is swung back over the mold to its position during filling.

The mold cover is opened and the lever arm depressed further until the block is completely ejected and held in this position until it is removed from the press and placed on edge at the curing site.

## Compressed stabilized earth blocks

### Manual presses



*Terastaram - Belgium*



*Unata - Europe*



*Elson Block Master - India*



*Balram - India*



*Astram - India*



*Auram Press 290 - India*



*Auram Press 3000 - India*

[fig. 23a]

# Case Studies : Low-tech Construction

## Brick making

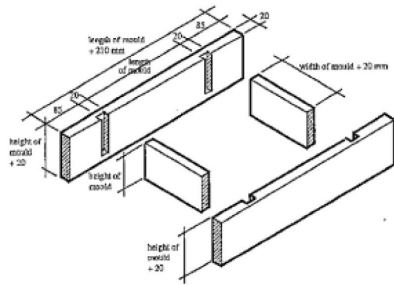

[fig. 24b]

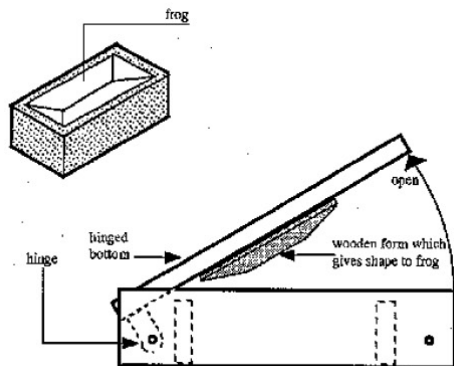
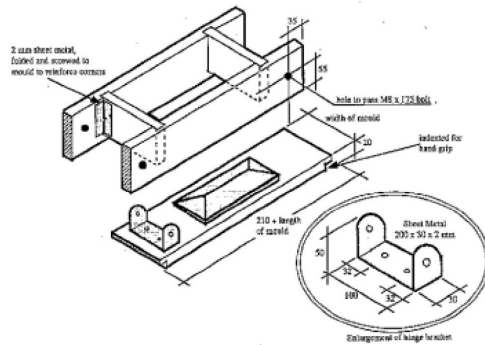

[fig. 24a]

fig. 23a shows a hinge mold for casting traditional clay bricks [fig. 23b]. The hinge mold has 3 main parts -

1. The mold box is where the brick is formed. The mold is made larger than the finished size of brick to allow for shrinkage during the drying and firing of the brick. The major wear areas are covered with sheet metal and the corners are reinforced with steel.
2. The hinged bottom allows the production of frogged bricks and the easy removal of the brick from the mold. The bottom is hinged on one side.
3. The frog is made from wood and is used to form a cavity or indentation on one side of the brick. The frog makes the brick weigh less, allows it to dry and fire faster (saving firewood) and gives the brick a form which improves its adherence when laid in a wall [URL 10].

Mold design forms a major component of a low-tech indirect manufacturing process. The most important factor that has to be accounted for is the material being used for casting. CSEB needs higher degree of compression whereas country bricks are made out of a moldable composite which requires less pressure for casting.

## Brick making



[fig. 25a]

Country bricks are fired in kilns or in the open using fire wood. It is an industry that provides employment to a large section of people living in the country side.

The bricks are allowed to dry at least for a period of 7-8 days depending on the moisture content in the composite. After drying, the bricks are baked to increase their strength and longevity.

Repeatable production is sustainable since it utilizes few molds to produce a large quantity of units as compared to manufacturing one off molds to produce unique casts.

## Case Studies : Low-tech Construction

### FORMBLOCK

FORMBLOCK is a wall building system in which stabilized earth, or concrete blocks are cast in-situ to produce a solid load bearing wall. In use now for over 15 years in a range of conditions throughout Australia and New Zealand, it has been thoroughly tested by professionals, architects and owner builders.

The FORMBLOCK Wall Kit is designed in 300 mm modular units that is easily assembled to produce a course of blocks, each 600 mm long, 300 mm high, 300 mm thick, it fits neatly with other conventional building systems. The FORMBLOCK Wall Kit requires no expert skill, it is easy to use and simple to understand and is ideally suited to tradespersons, owner builders, and handypersons, alike.

The FORMBLOCK method significantly reduces the labour required to produce an earth wall as compared to adobe (mud brick) or pisé (rammed earth) methods of earth building. The handling of the earth material is minimized, by the in-situ nature of block making. Once the blocks are poured, the wall is effectively complete, with no further need of on going maintenance.



[fig. 26a]

## FORMBLOCK

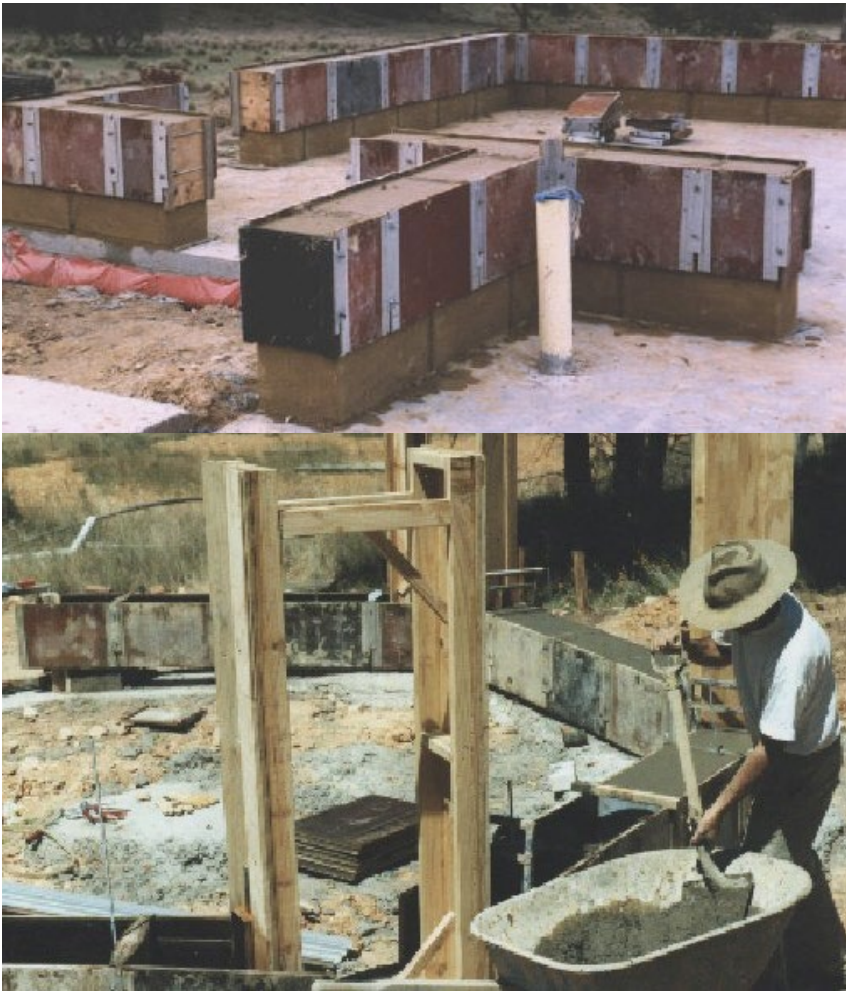

[fig. 27a]

The FORMBLOCK Wall Building Kit conserves natural resources. Producing earth-based blocks, contributes in saving energy otherwise used by industry to produce other building materials, such as fired bricks, etc. Less reliance on timber, means less deforestation. The FORMBLOCK system is not a wasteful 'once only use' formwork, it is designed and made for long lasting repeated use.

The method of construction involves the creation of blocks and assembly at the same time making the FORMBLOCK system a cost effective and affordable method of masonry wall construction.

## Case Studies : Low-tech Customization

Mass-customization existed in the design and production realm even before the introduction of computer numerically controlled machines. Permutations and combinations of parameters within a certain set of **rules** can produce customized results.



[fig. 28a]

### Factory Art : Terracota warriors, China

The makers of clay drainage pipes were employed in constructing this army of warriors. A set number of molds were created to cast different parts of the body. Each warrior is a unique assembly. The uniqueness is a result of permutations and combinations generated from body parts cast out of a fixed number of molds.

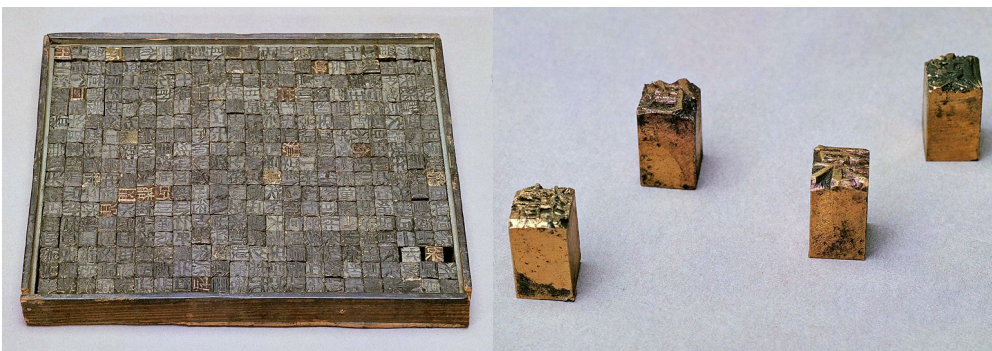

[fig. 28b]

### Block Printing : Bronze and wood blocks, China

Interchangeability is another attribute of mass-customization. Woodblock printing is a technique for printing text, images or patterns used widely throughout East Asia and originating in China in antiquity as a method of printing on textiles and later paper.

## Case Studies : Static shading devices

Static shading devices act as passive building skins and have been used as important architectural elements, especially in hot and arid climates.

A 'jali' made in stone is one such element used in vernacular Mughal [Baweja, 2008] and Rajput [Gupta, 1985] architecture of India. In Hindi, a 'jali' means a net or a screen. In the literal sense, this device was used for screening interior areas from excess solar penetration [fig. 24a, b]. These intricately carved patterns would also add to the aesthetic qualities of facades.

Two laws of physics turn jalis into air-conditioners: the principles of Venturi and Bernoulli [URL 11].

- a. Venturi's Principle states that air is compressed and increases its speed when passed through a funnel causing a breeze.
- b. Bernoulli law states that when air is compressed and released it becomes cool.

Static shading devices have also been used as vital elements in modern architecture [fig. 25 a, b]. Corbusier has incorporated Brise Soleils in most of his projects in India. Such devices/elements, expressed in different forms, have been strategically used in enhancing the environmental performance of buildings.



[fig. 29a] Sidi Syed Mosque, Ahmedabad, India



[fig. 29b] Salim Chishti's tomb, Fatehpur Sikri, India



[fig. 30a] Palace of Assembly, Chandigarh, India

Architect : Le Corbusier



[fig. 30c] Ahmedabad Textile Mill Owners' Association House (ATMA House), Ahmedabad, India

Architect : Le Corbusier



[fig. 30b] Ahmedabad Textile Mill Owners' Association House (ATMA House), Ahmedabad, India

Architect : Le Corbusier



[fig. 31a] Brick Jaali by Laurie Baker

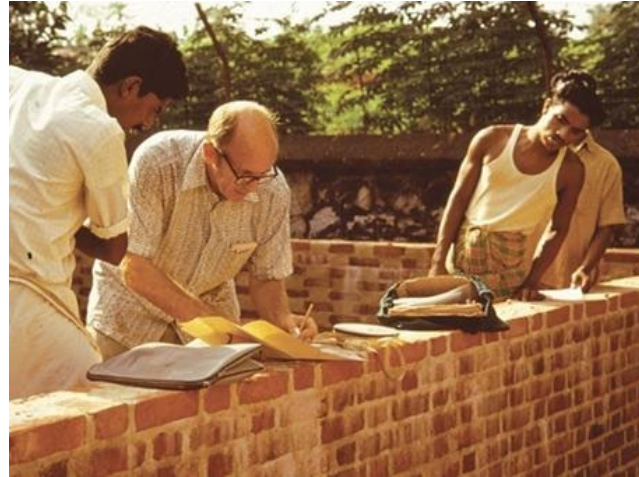

[fig. 31b] Laurie Baker at work



[fig. 31c]

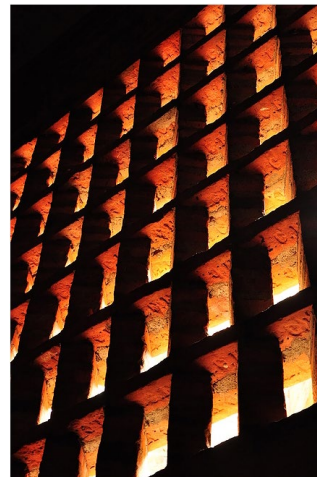

[fig. 31d]



Brick Jali :

Figures 28a, b, c & d show jali configurations produced using bricks by architect Laurie Baker in India. Fig. 28a shows how the brick screen shields the interior walls from direct solar exposure and provides indirect light to the corridor. This approach is a good example of a sustainable design and construction practice since it is economical and responds to the hot tropical climate of India.

In current times, Jali modules are being made in different materials, mostly moldable composites such as poured concrete, cast clay/earth, terracotta, fly-ash etc.

These Jali modules are available in standard sizes and shapes unless customized. Customized production has added costs. Many designers have been halted in their approaches from moving beyond the digital world primarily because of the cost of producing variation at any scale. This is because digitally enabled mass-customization increases material costs since it demands the production of individual molds for casting all the unique modules/components.



[fig. 32a] Jali modules made out of terracota

## Case Studies : Observations

Several high-tech design approaches have evolved in the realm of architecture after the introduction of digital tools. Parametric modeling has emerged as a vital tool that has aided the formulation of these approaches. Parametric modeling offers greater adaptability as it enables the creation of shapes that can respond automatically to changes later in a design process. Achim Menges, in his essay *Instrumental Geometry* [2010], argues that design is an iterative process that involves exploration and resolution of ambiguity; therefore, computational tools that enable modeling a static representation of a design is not sufficient. He justifies the use of parametric modeling tools by stating that digital tools need to be able to generate a range of potential solutions using the same underlying design principles. Such tools hold a vital stance in any design process since they facilitate the extraction of data for analysis, customization and fabrication from every unique iteration.

Performance based design techniques have compelled architects to view architecture through a more pragmatic lens. Digital tools designed for performance analysis play a crucial role in form-finding processes. Algorithmic search offers possibilities in optimizing performance of design objects. The “solution space” generated through parametric modeling can be refined using genetic algorithms to satisfy performance based objectives.

It is important to note that GAs can be applied to solve architectural problems only when their complexity can be disintegrated or simplified into combinatorial and/or numerical problems.

Indirect manufacturing processes such as casting are still being used as a low-tech methodology to manufacture architectural elements/components in most parts of the world. Repeatable production using locally available moldable composites makes the manufacturing process efficient and economical.

The couple of high-tech design and low-tech production is being explored in different ways as seen in the projects/experiments done by Griffith et al. and Kudless. The transfer of data, in such a process, from a digital to a physical environment is not seamless. The fabrication strategy developed for such a scenario, needs to address this discontinuous flow of information.

Prior to the existence of air conditioners, passive strategies to enhance the environmental performance of buildings were considered to be a major component of the design process [URL 14]. Certifications such as LEED have made it imperative for architects to reconsider such strategies in the design process. Static shading devices are considered to be an important passive strategy for cooling [URL 15]. Finding low-tech alternatives for passive cooling is an interesting area of research.

Rhinoceros 5.0 [URL 16], a digital modeling platform, offers parametric modeling functionality through a graphical scripting plug-in called Grasshopper (GH) [URL 12]. Galapagos [URL 17] is a component built to operate within the GH environment for optimization through genetic algorithms. GECO [URL 18] is another component made to function as a solar analysis tool within the GH environment. A script can be generated in GH using these components to build a feed-back loop to optimize the environmental performance of a geometrical construct.

The ability to generate multiple variations, by tweaking parameters, and visualize them has made parametric modeling quite popular within the design realm. It is not only possible to visualize but also analyze each unique iteration of a parametric model. In addition to these features, data required to fabricate each iteration can be easily extracted from the same model.

Prior to the invention of digital tools, it was possible to generate variation and customize designs for specific needs. In such a scenario design iterations had to be physically produced for testing and analysis. But, digital tools make it possible to visualize and analyze different iterations without the need to physically produce them, thus saving time, money and effort. Customization through such a numerical control is pushing the boundaries of research and experimentation.

parametric modeling + analysis

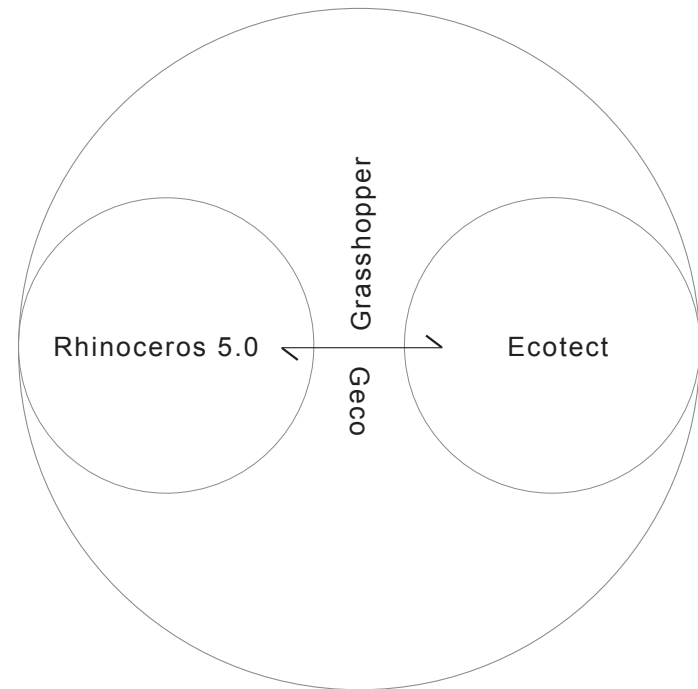

[fig. 34a]

## Thesis statement

The production of variation generated by high-tech generative design tools can be facilitated by making simple yet informed adjustments to a well established low-tech repeatable production methodology.

### Project goals

**To develop a computational tool for designing a customizable static shading device (assembly)  
integrating low-tech production methodologies**

design (high-tech)



production + assembly (low-tech)



+

[fig. 36a]

The tool should allow designers

1. to generate block geometries and develop assemblies to control direct solar penetration based on site location and programmatic requirements taking geographical location and facade orientation into consideration.
2. to extract information for low-tech fabrication

design engine



GH definition has to incorporate the fabrication strategy to generate variable block geometries. And, analyze shading conditions developed by the block assemblies.

mold

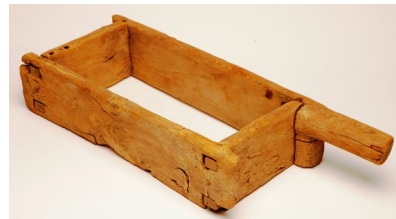

Variable block geometries can be generated via tilting the mold in a strategic manner.

product

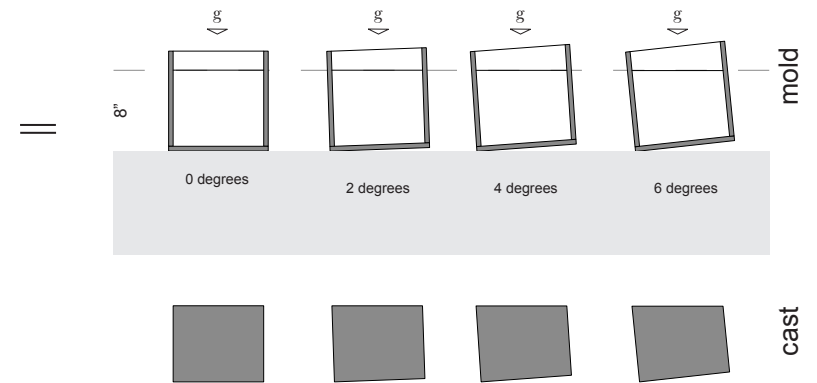

[fig. 37a]

# Hi - Lo

## Project diagram

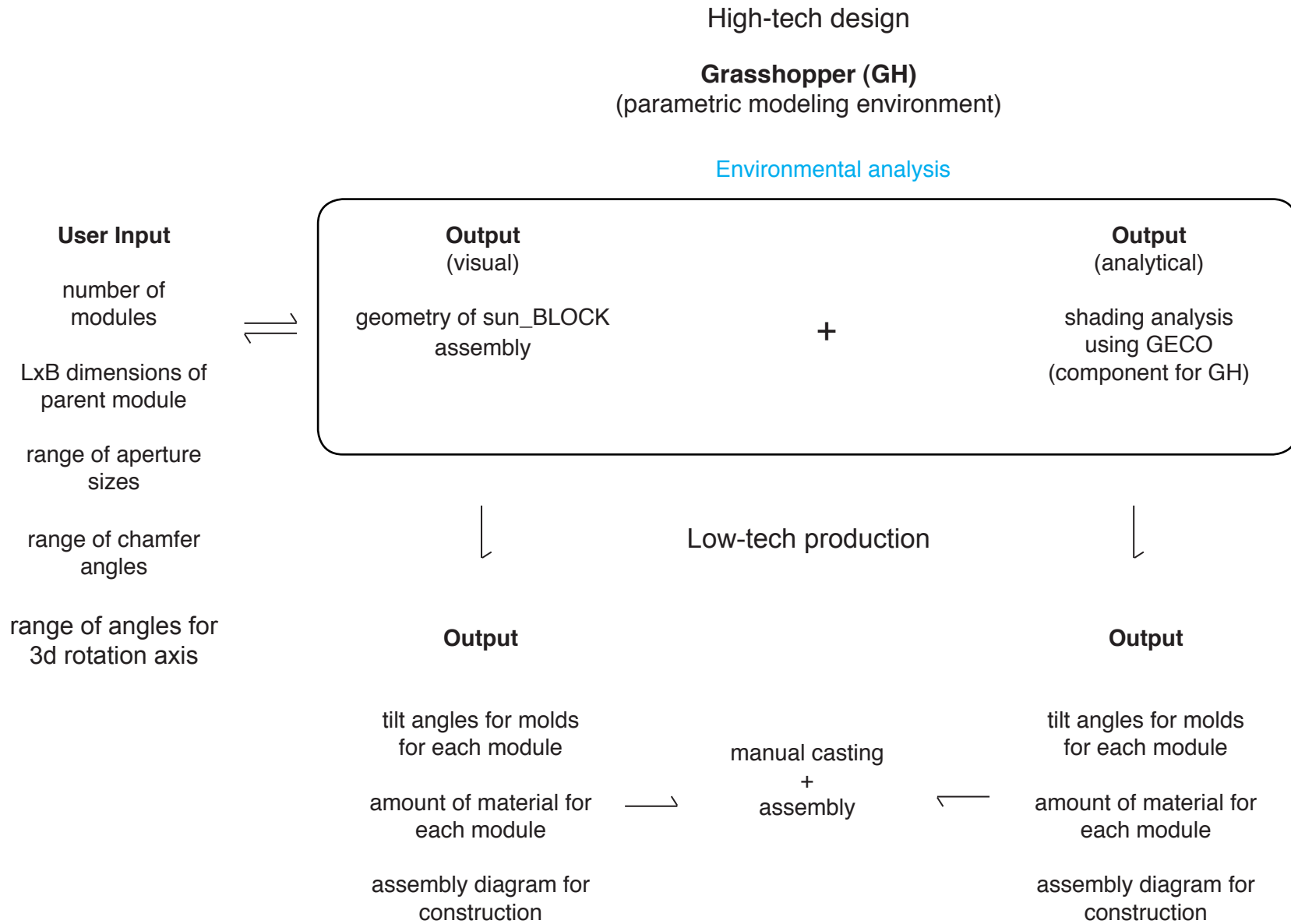

## Hi - Lo

### Lo - tech production : casting {concept}

The process of experimentation began with a cube measuring 10" in length, breadth and height. A void measuring 5" x 5" x 10" was introduced in the center to reduce weight and allow solar penetration. Different iterations can be generated by tilting the mold and using different inserts to control void geometries. The diagram shown below illustrates the concept.

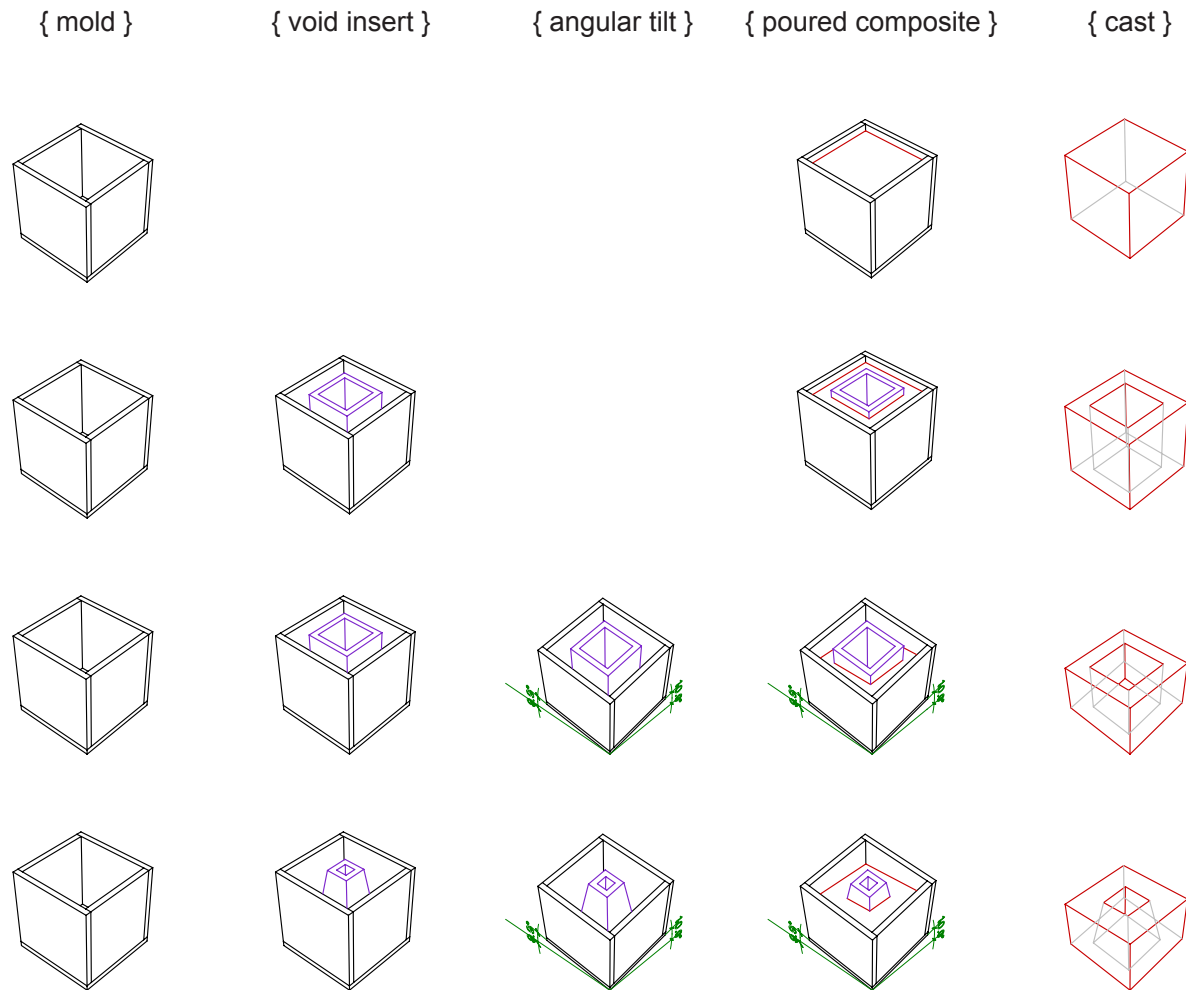

[fig. 39a]

## Hi - Lo

### Hi - tech design : parametric modeling

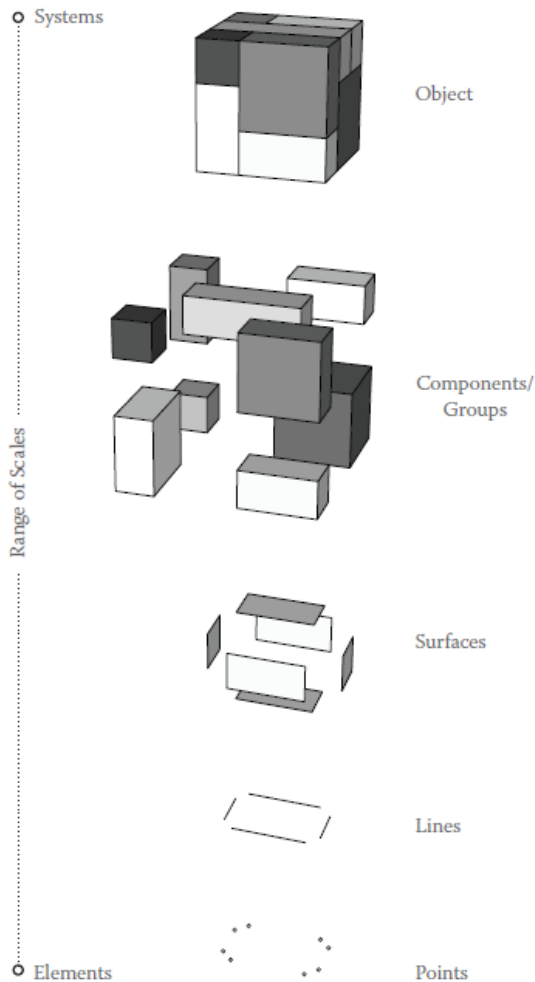

[fig. 40a] Geometric system

Grasshopper (GH) is a generative modeling application for Rhinoceros 5.0, developed by David Rutten. It is structured as a component/node based visual scripting application, that follows the geometric system developed for Rhinoceros [fig. 31a].

Like most other parametric modeling tools, Grasshopper can be used to generate associative geometry by establishing parametric relations between topological features. The geometry is controlled through the use of components that are connected together with wires similar to an electrical diagram. Each component has inputs and outputs, but they can control a wide range of parameters ranging from geometry to logic rules to transformations. The tool allows custom component development through VBscript, C# , Rhinoscript, and Python. There are plug-ins/custom components developed for different applications and are available at [www.food4rhino.com](http://www.food4rhino.com).

Customization // Component : parametric model

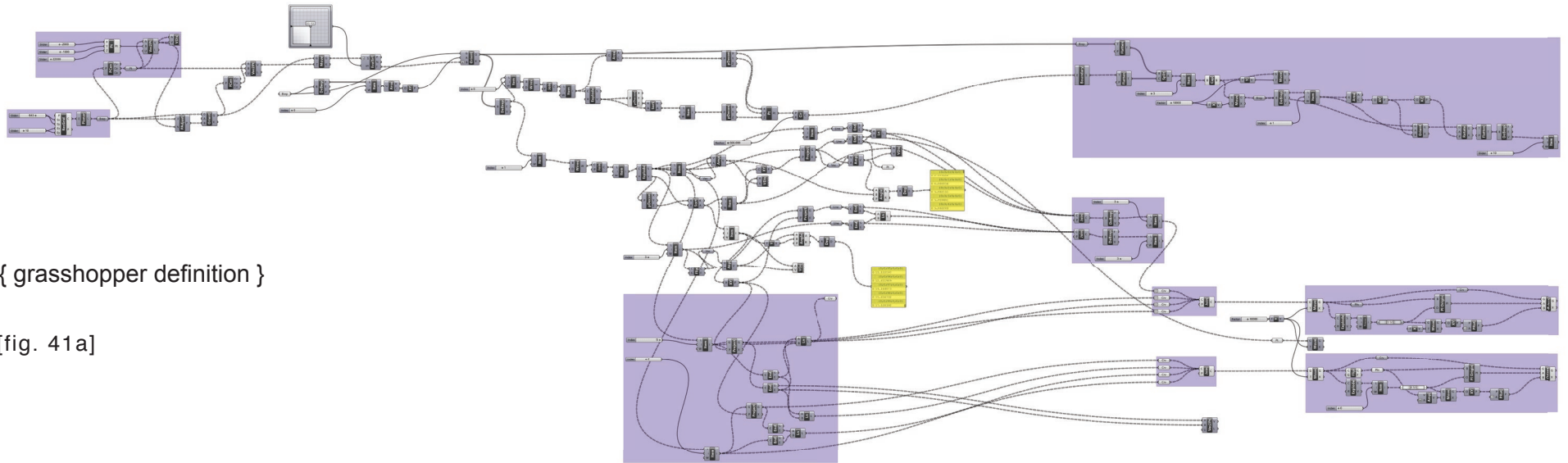

{ grasshopper definition }

[fig. 41a]

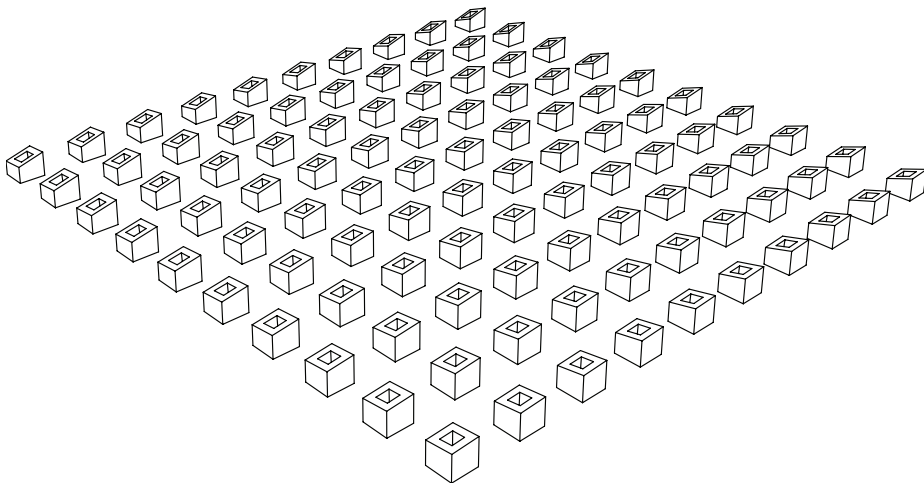

{ 100 unique blocks } [fig. 41b]

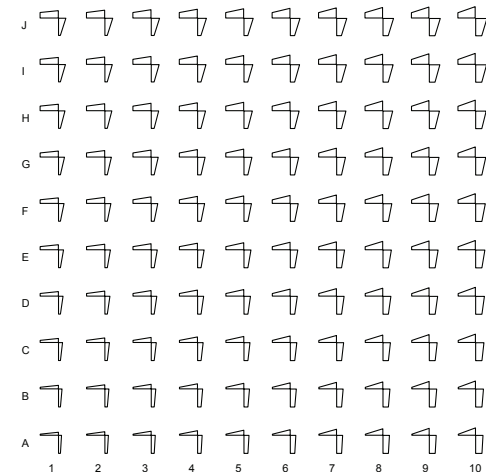

{ tilt angles }

[fig. 41c]

## Customization // Component : parametric model

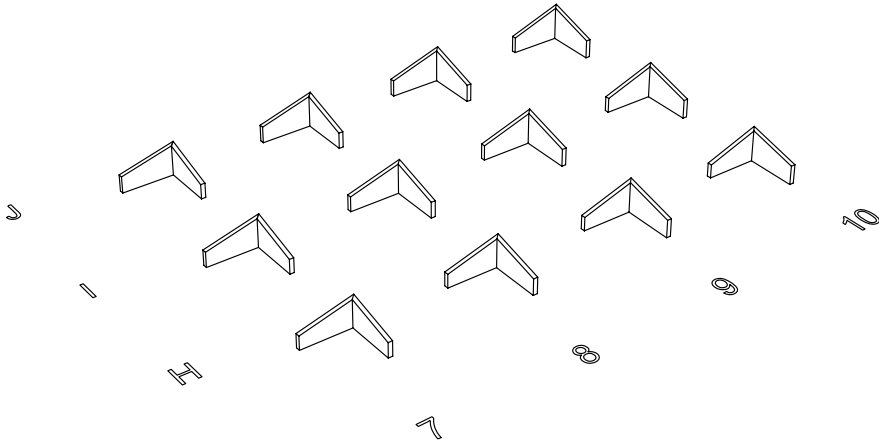

[fig. 42a]



[fig. 42b]

The fabrication logic of tilting the mold and using different inserts to generate unique blocks was embedded in a Grasshopper definition (fig. 41a).

The definition was made to generate a hundred unique blocks (fig. 41b). Tilt angles for each block were extracted using the same definition. These tilt angles were used to generate cut profiles to make pieces to control the angular tilt of the mold assembly (fig. 42b).

## Hi - Lo

### Lo - tech production : casting {prototyping}

A full scale prototype was developed using hydrocal. A hinged mold assembly was developed using 1/2" pre-laminated board. The tapered void insert was made out of 1/8" Luan.

The void insert was waxed to lessen friction while extracting the cast. Petroleum jelly was used as a release agent. The mold was tilted using pieces made out of 3/4" plywood. The cut profiles for these pieces were extracted using a GH definition (fig. 41a).

The images on pages 43 and 44 explain the steps adopted during the prototyping process.

This test was performed to study the process and validate the concept.

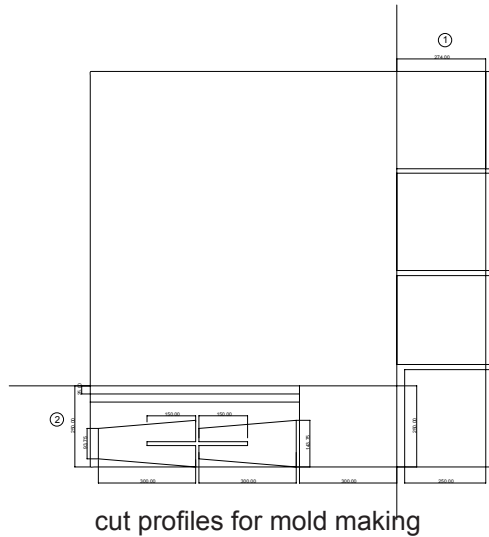

1. angular profiles being cut



2. wax heated up for sealing



[fig. 43a]

3. parts of mold being waxed



4. excess wax being removed



5. applying release agent : vaseline



6. applying release agent  
: PAM



7. sealing edges using tape



8. tilted mold assembly



9. hydraulic mixture



10. first batch poured

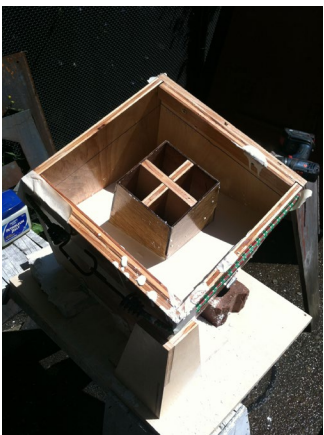

11. second batch poured



12. caution mark reached



13. cast ready // curing time :  
1 day

The result very clearly demonstrates that it is possible to facilitate the production of unique blocks generated using grasshopper by simply tilting the mold.

The next set of tests are performed to analyze how different block geometries and their assemblies affect solar penetration. The tests are performed with the GH environment, using environmental analysis tools such as Ecotect and DIVA.

[fig. 44a]

## Hi - Lo

### Hi - tech design : solar analysis

#### Grasshopper + Ecotect

Geco is a plug-in developed for evaluating environmental performance through Ecotect. Geco establishes a link between the geometry generated through Grasshopper and Ecotect. Geco, in this research is used for shading analysis.

A typical Geco workflow adopted in the experiments involves the following steps -

1. The EcoLink component [fig. 45a] is used to establish links between GH and Ecotect. A boolean toggle is used to switch the link on and off.
2. The EcoSunpath [fig. 45b] is used to generate a solar path based on
  - a. geographical location
  - b. month
  - c. day
3. The EcoSunRays [fig. 45c] component is used to calculate solar vector(s) based on time intervals during a diurnal cycle.
4. The mesh shadow [fig. 45d] component is used to generate shadows

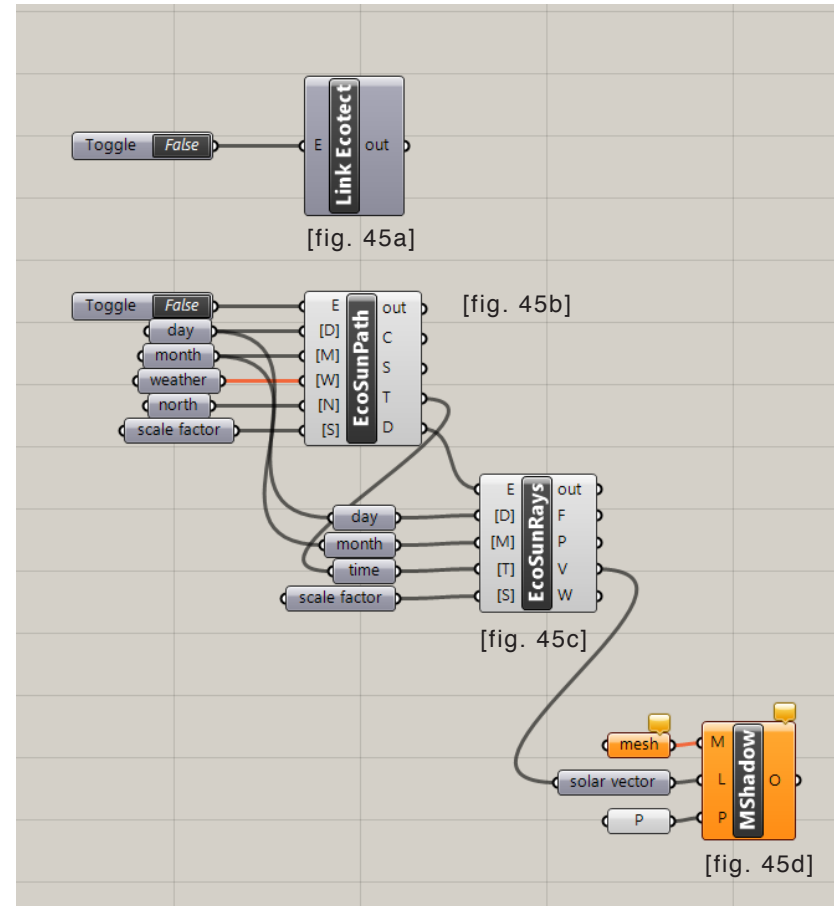

## Hi - tech design : solar analysis

### DIVA FOR RHINO

DIVA FOR RHINO is a daylighting and energy modeling plug-in for Rhinoceros 5.0 [URL 22]. It was initially developed at the Graduate School of Design, Harvard University and is now distributed by Solemma LLC.

Diva is used in the tests for this project to generate Radiance renderings for analyzing the behavior of light in an interior space.

The geometry of assemblies used for testing were generated using GH and were unified using the boolean union component before baking to produce a NURBS geometry. The NURBS geometry was then used for Diva analysis. The following parameters were selected for the analysis.

a. Location : New Delhi

b. Daylighting Materials :

Ceiling : GenericCeiling\_70

Floor : GenericFloor\_20

Walls and facade to be tested : OutsideFacade\_35

C. The parameters selected for simulation are as shown in fig. 46a

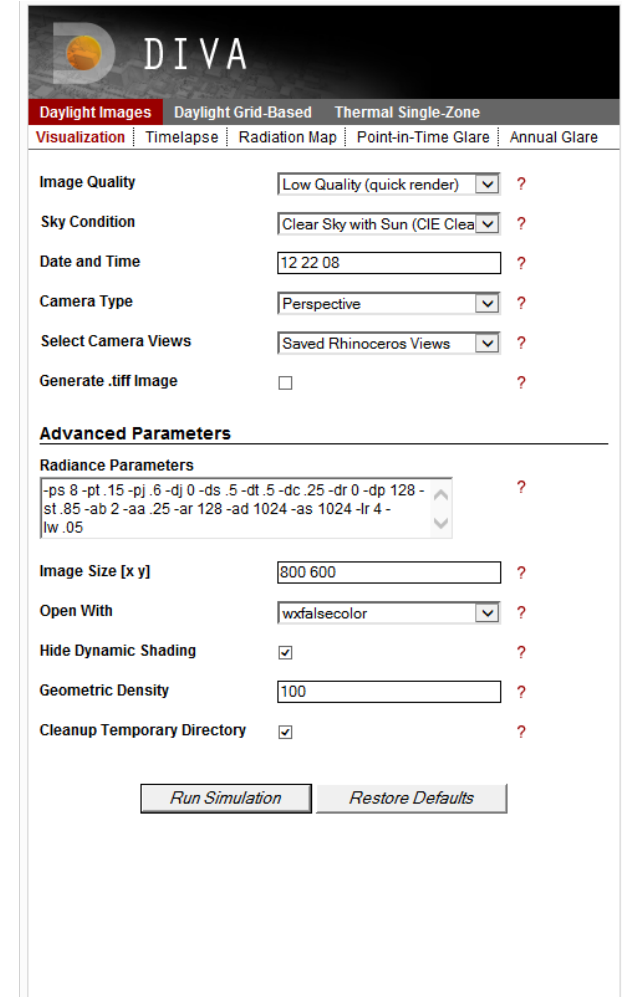

[fig. 46a]

## Hi - Lo

Hi - tech design : solar analysis

information flow

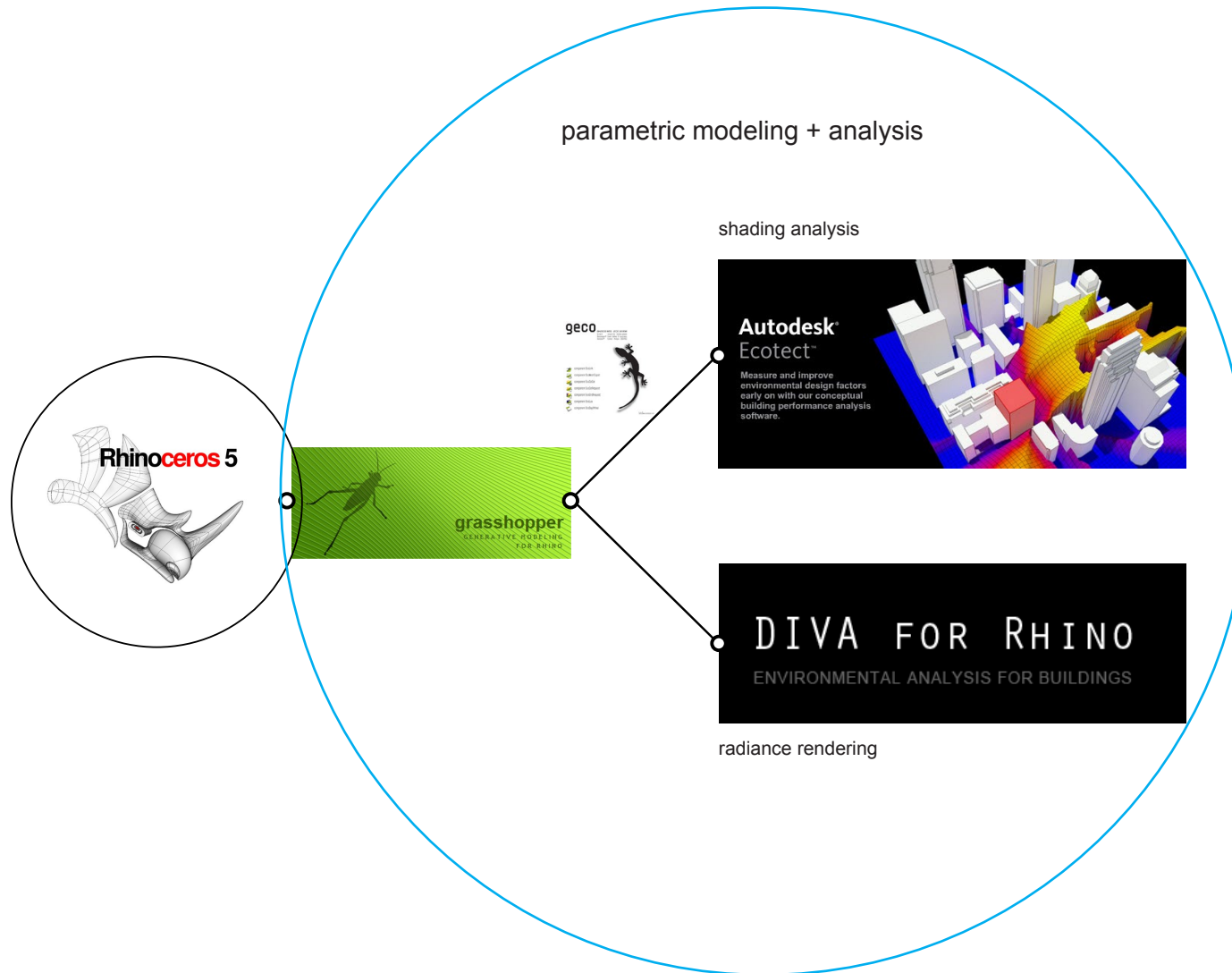

## Hi - Lo

### Hi - tech design : solar analysis

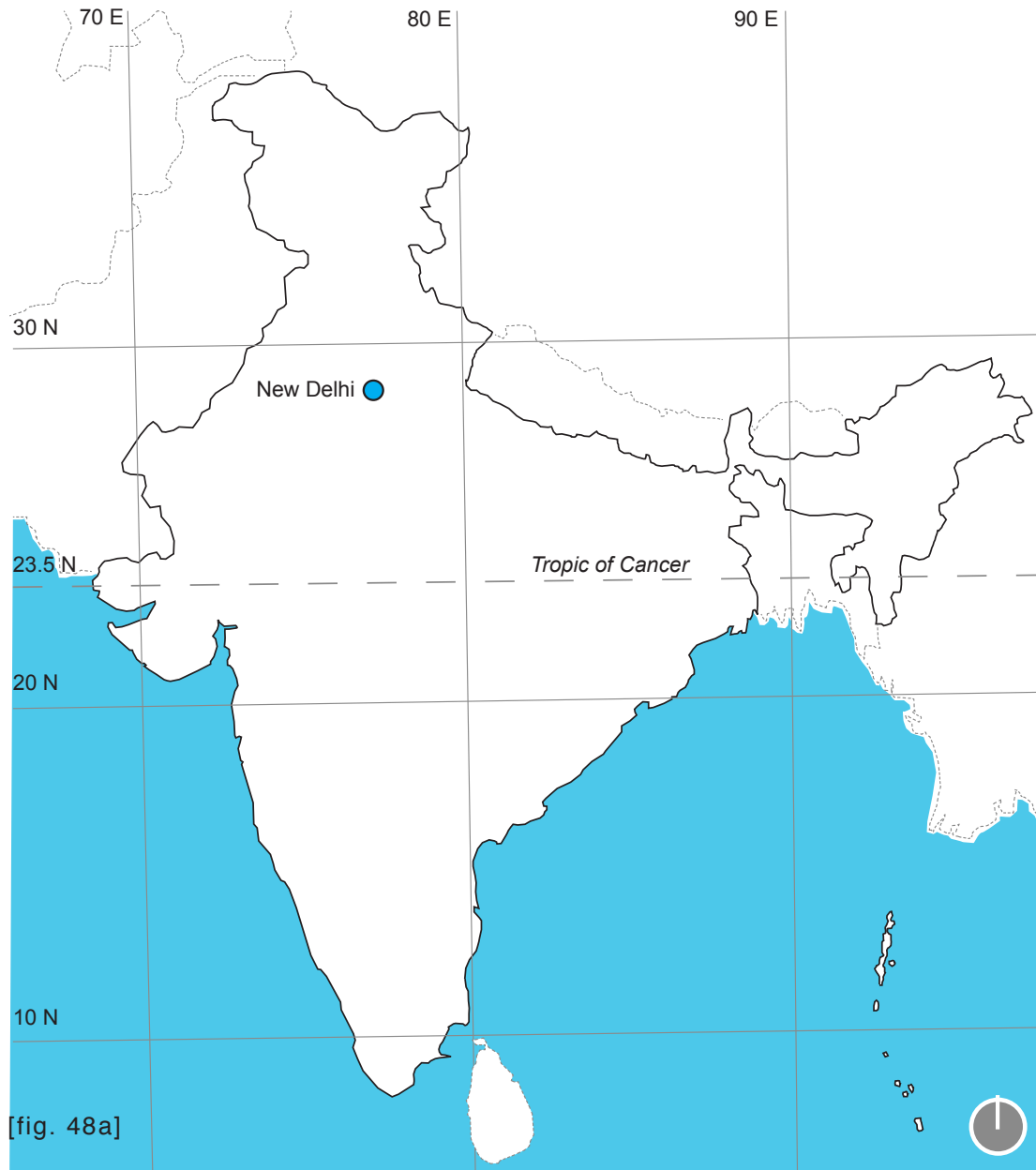

#### New Delhi

28°36'50"N 77°12'32"E

Altitude : 216 m (709 ft)

Distance from Tropic of Cancer : 360 miles

Day : Dec. 22 (Winter Solstice)

sunrise : 7.10 am

sunset : 5.29 pm

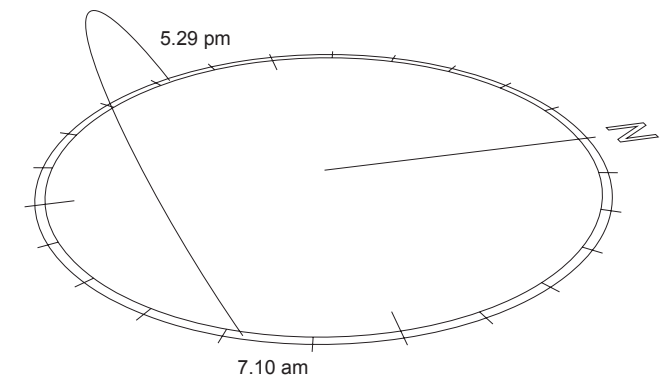

[fig. 48b]

Geometries of individual blocks and their assemblies are tested on Dec. 22 in New Delhi (India) to observe solar penetration. During winter the solar angles are low and solar penetration is maximum.

## Customization // Component : solar analysis

### TEST 1

Location : New Delhi (28°36'50"N 77°12'32"E)

Day : Dec. 22 (Winter Solstice)

- A. size of block : 10" x 10" x 10"  
size of aperture : 7" x 7" x 10"

block 1

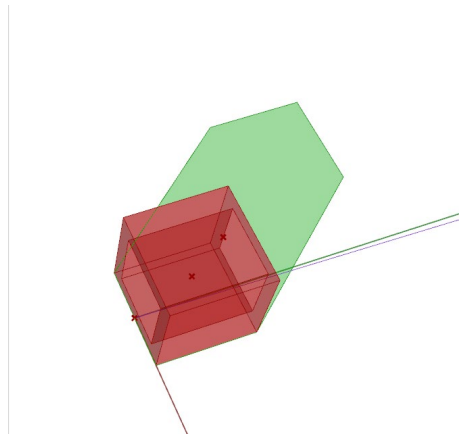
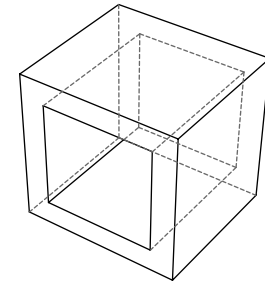

fig 49a . shadow at 9 am

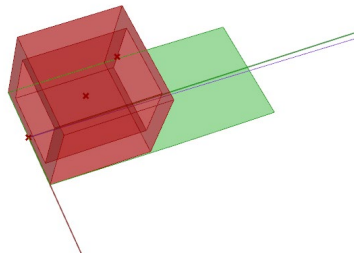

fig 49b . shadow at 12 pm

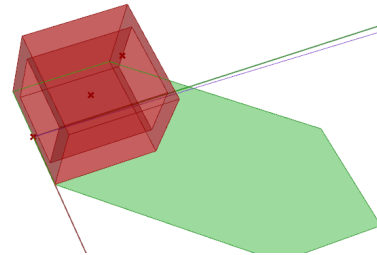
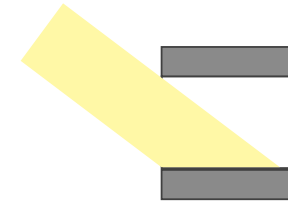
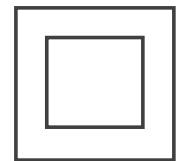

fig 49c. shadow at 3 pm



section



elevation

### Observations

The depth (10") doesn't allow direct solar penetration.

Weight of the block (concrete) : 44.27 lb

Shading : 100 %

## Customization // Component : solar analysis

### TEST 1

Location : New Delhi (28°36'50"N 77°12'32"E)

Day : Dec. 22 (Winter Solstice)

- B. size of block : 10" x 10" x 9"  
size of aperture : 7" x 7" x 9"

### block 2

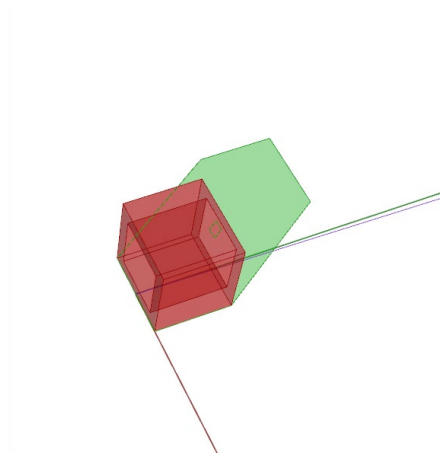
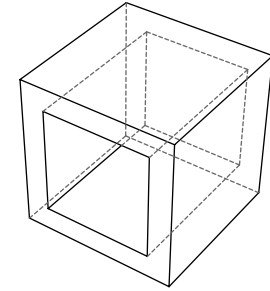

fig 50a. shadow at 9 am

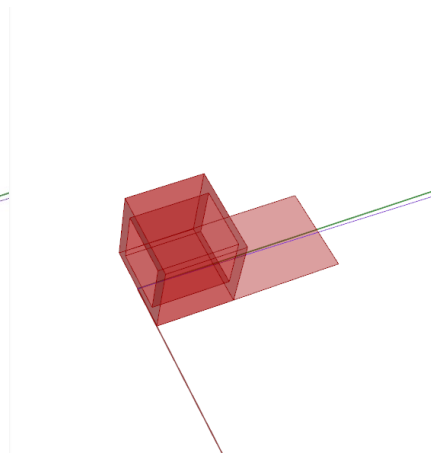

fig 50b. shadow at 12 pm

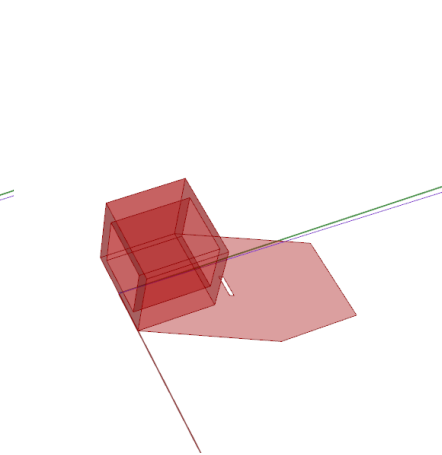
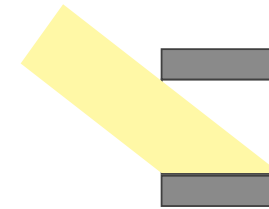
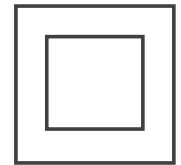

fig 51c. shadow at 3 pm



section



elevation

### Observations

The depth (9") doesn't allow direct solar penetration at 12 pm.

Weight of the block (concrete) : 39.84 lb

Shading at 9 am : 94 %

Shading at 12 pm : 100 %

Shading at 3 pm : 94 %

## Customization // Component : solar analysis

### TEST 1

Location : New Delhi (28°36'50"N 77°12'32"E)

Day : Dec. 22 (Winter Solstice)

C. size of block : 10" x 10" x 6"  
size of aperture : 7" x 7" x 6"

### block 3

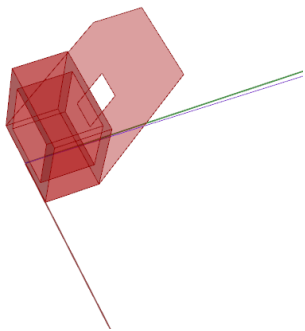
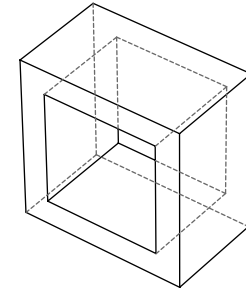

fig 51a. shadow at 9 am

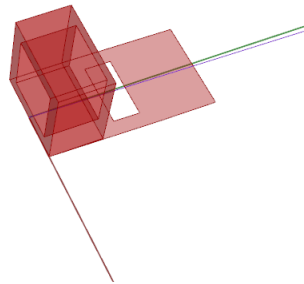

fig 51b. shadow at 12 pm

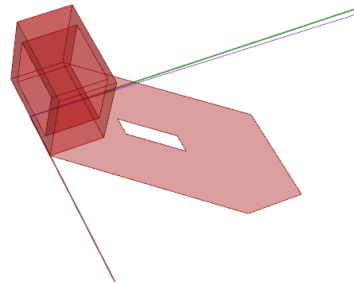
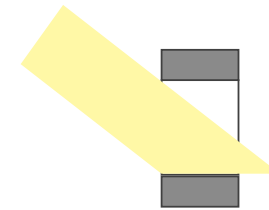
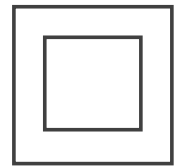

fig 51c. shadow at 3 pm



section



elevation

### Observations

The depth (6") allows direct solar penetration.

Weight of the block (concrete) : 26.56 lb

Shading at 9 am : 96%

Shading at 12 pm : 85 %

Shading at 3 pm : 96%

## Customization // Component : solar analysis

### TEST 1

Location : New Delhi (28°36'50"N 77°12'32"E)

Day : Dec. 22 (Winter Solstice)

D. size of block : 10" x 10" x 7"  
size of aperture : 3.5" x 7" x 7"

### block 4

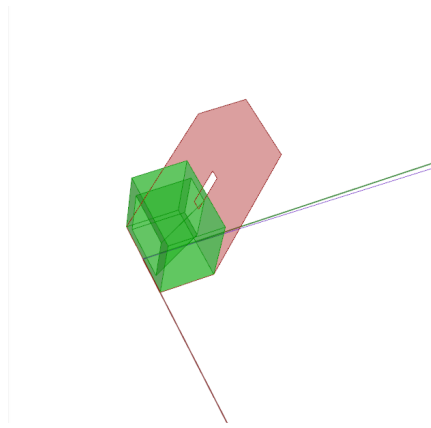
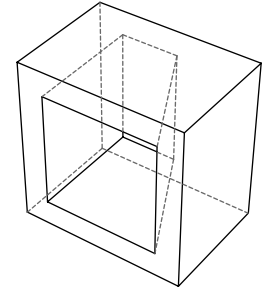

fig 52a. shadow at 9 am

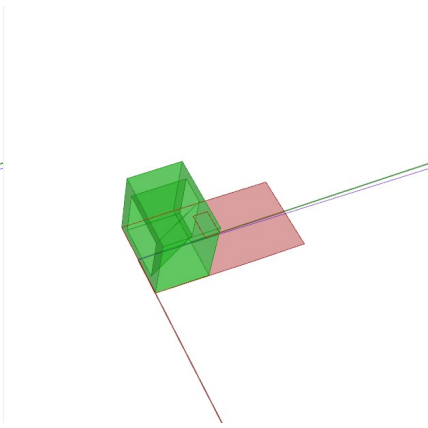

fig 52b. shadow at 12 pm

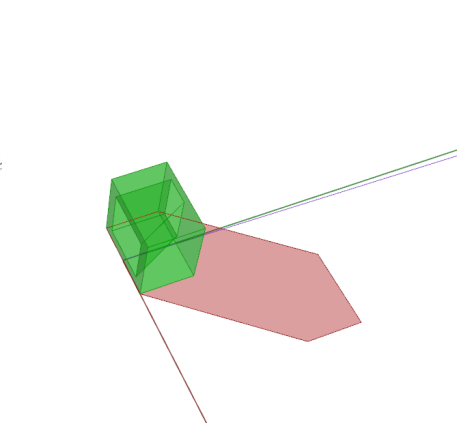
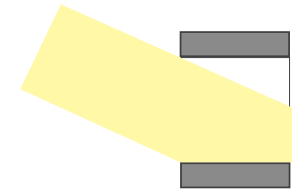
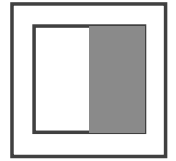

fig 52c. shadow at 3 pm



section



elevation

### Observations

The depth (7") doesn't allow direct solar penetration 1 pm onwards.

Weight of the block (concrete) : 38.43 lb

Shading at 9 am : 98 %

Shading at 12 pm : 96 %

Shading at 3 pm : 100 %

## Customization // Component : solar analysis

### TEST 1

Location : New Delhi (28°36'50"N 77°12'32"E)

Day : Dec. 22 (Winter Solstice)

E. size of block : 10" x 10" x 7"  
size of aperture : 7" x 3.5" x 7"

### block 5

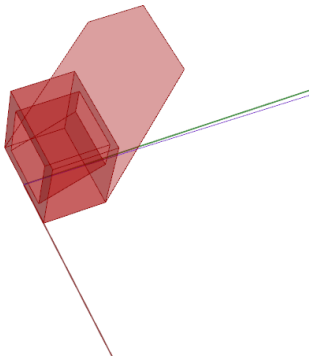
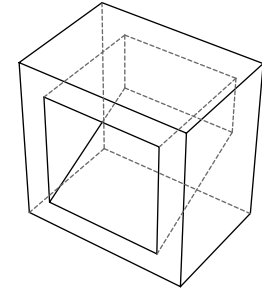

fig 53a. shadow at 9 am

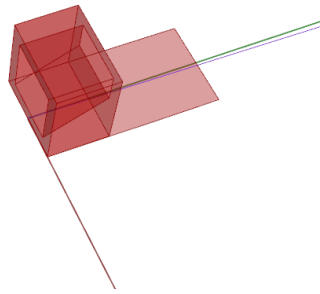

fig 53b. shadow at 12 pm

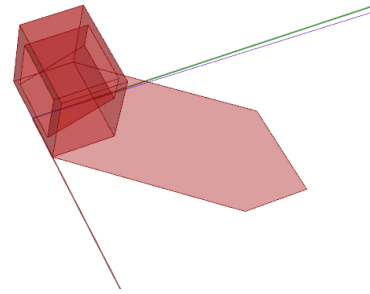
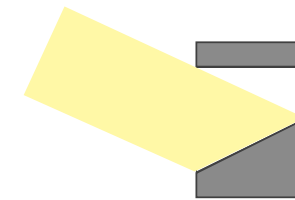
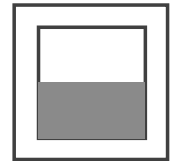

fig 53c. shadow at 3 pm



section



elevation

### Observations

The depth (7") doesn't allow direct solar penetration

Weight of the block (concrete) : 38.43 lb

Shading at 9 am : 100 %

Shading at 12 pm : 100 %

Shading at 3 pm : 100 %

## Customization // Component : solar analysis

### TEST 1

Location : New Delhi (28°36'50"N 77°12'32"E)

Day : Dec. 22 (Winter Solstice)

F. size of block : 10" x 10" x 7"  
size of aperture : 7" x 3.5" x 7"

### block 6

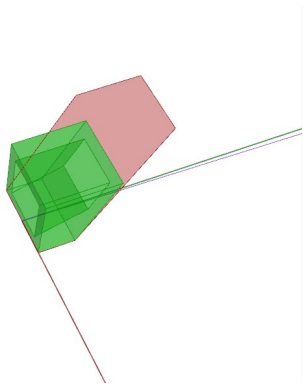
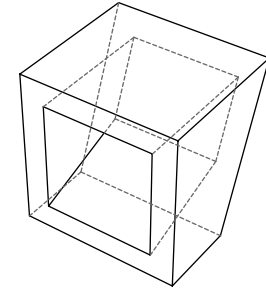

fig 54a. shadow at 9 am

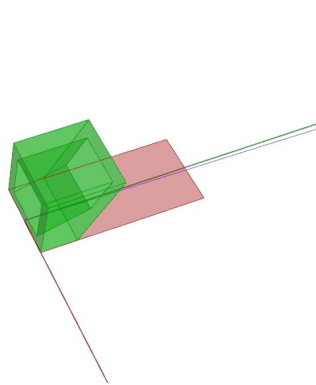

fig 54b. shadow at 12 pm

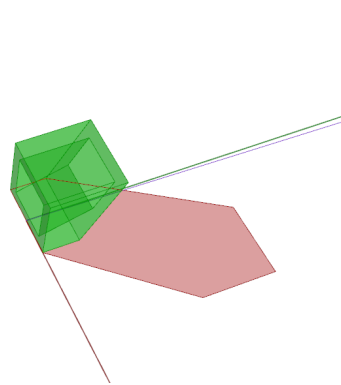
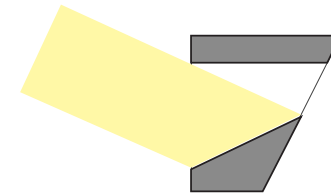
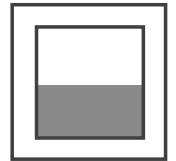

fig 54c. shadow at 3 pm



section



elevation

### Observations

Chamfered block (max. depth 10")

Weight of the block (concrete) : 37.46 lb

Shading at 9 am : 100%

Shading at 12 pm : 100 %

Shading at 3 pm : 100%

## Customization // Component : solar analysis {conclusions}

Winter sun is taken into account for studying these cases since the system doesn't allow direct solar penetration during summer because of the depth of the block. The blocks have to be really thin for summer sun to penetrate directly. The summer temperature ranges between 40C(104F) to 48C (118F) in most cities in the Indian subcontinent. Hence blocking direct solar penetration during summer becomes extremely important.

Coastal cities like Mumbai and Chennai remain quite humid throughout the year. The highest temperature during winter reaches 32C (90F) thus it becomes important to block direct solar penetration after 12 pm since the temperature start soaring after noon.

Cases A, B and C clearly demonstrate that **solar penetration can be controlled by changing the depth of the block**. However, a constant change in depth doesn't allow the geometry to block solar penetration during certain intervals of the day.

Cases D, E and F display some interesting results. The geometry in case D allows blocking direct solar penetration after 1 pm. If the same block is rotated 90 degrees (Case E), there is no solar penetration throughout the day. And, if the same block is rotated 180 degrees, the geometry would block solar penetration until 1pm. Case F performs in the same manner as Case D but is lighter by 1lb than Case D.

**These observations clearly indicate that the shape of void, the degree of chamfer and the orientation of the block play a vital role in controlling solar penetration.** This degree of micro control may be difficult to achieve using standard units such as bricks.

The tests also justify this particular size and shape of the block. The shape of the void can be controlled by using different inserts during the process of casting. A mold measuring 10" x10"x10" (cuboidal) can very comfortably accept different void inserts. Having a void in the block increases surface area. Greater surface area allows excess moisture to easily escape which reduces swelling of the soil. This action reduces cracking during the process of curing.

The presence of a void in a building block also contributes towards controlling air flow and visibility (and therefore privacy). Tests for understanding the effect of these parameters with respect to block geometries have not been performed in this exploration.

TEST 2

Location : New Delhi (28°36'50"N 77°12'32"E)  
Day : Dec. 22 (Winter Solstice)

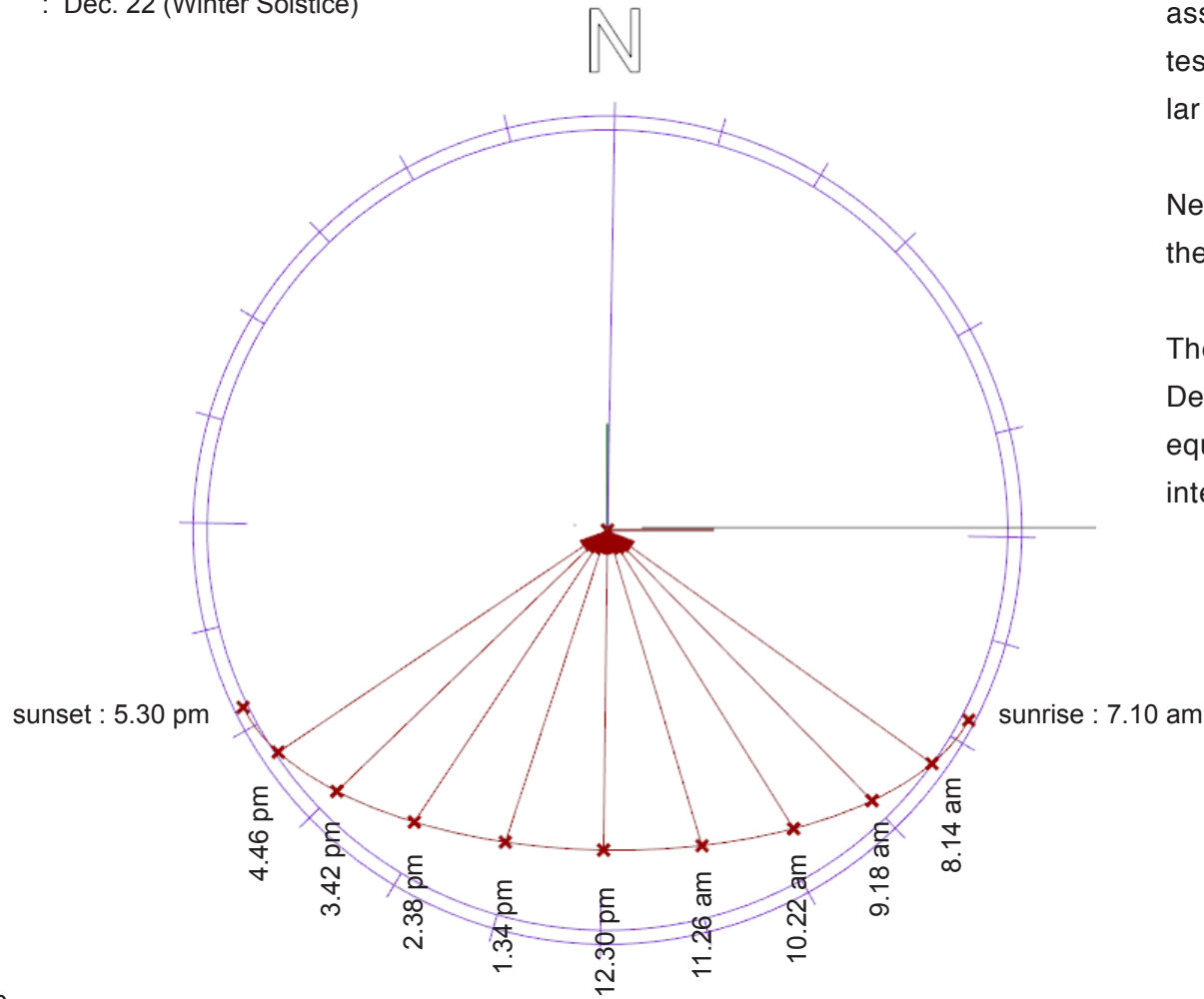

The next set of tests were performed for different assemblies using the same block geometry. These tests were performed to observe the change in solar penetration at 10 intervals during the day.

New Delhi (India) was selected as the location for the tests performed on Dec 22.

The diagram on the left shows the solar path on Dec 22 in New Delhi. The curve is divided in to 10 equal segments and every segment denotes a time interval during the day as shown in the diagram.

fig. 56a.

# Customization // Assembly : solar analysis

## TEST 2

Location : New Delhi (28°36'50"N 77°12'32"E)

Day : Dec. 22 (Winter Solstice)

### case A.

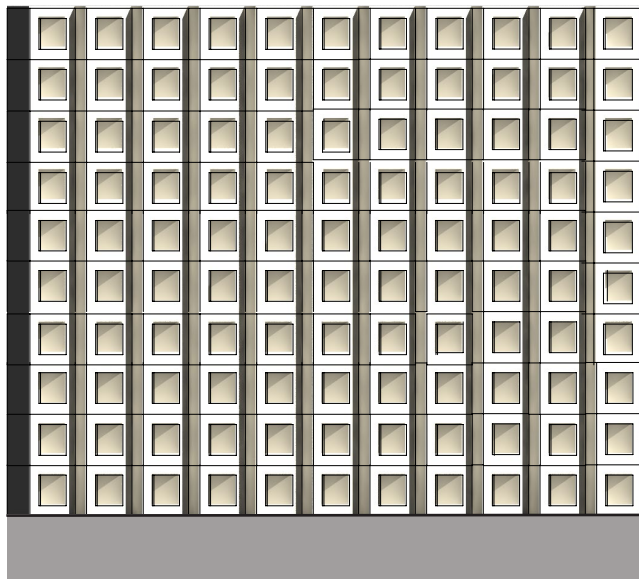

Elevation

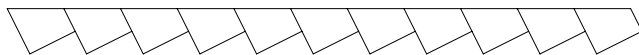

Plan

### block 7

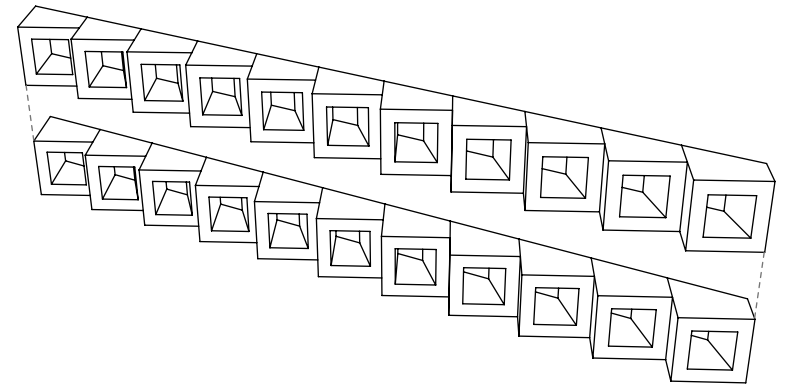
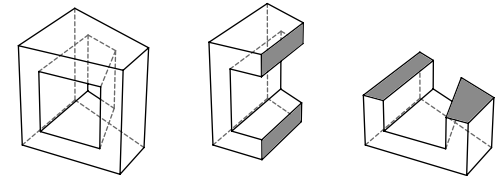

Stacking logic

[fig. 57a]



block 7

case A.

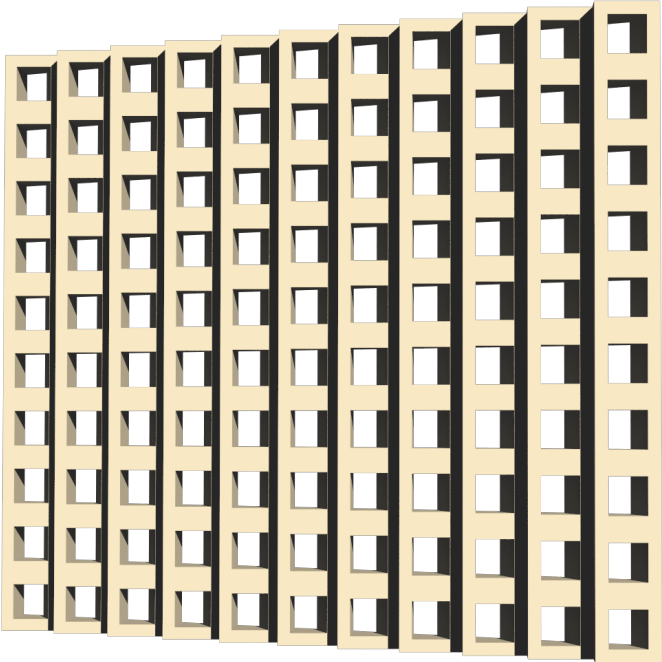

Rendered view

[fig. 58a]

Customization // Assembly : solar analysis

case A.

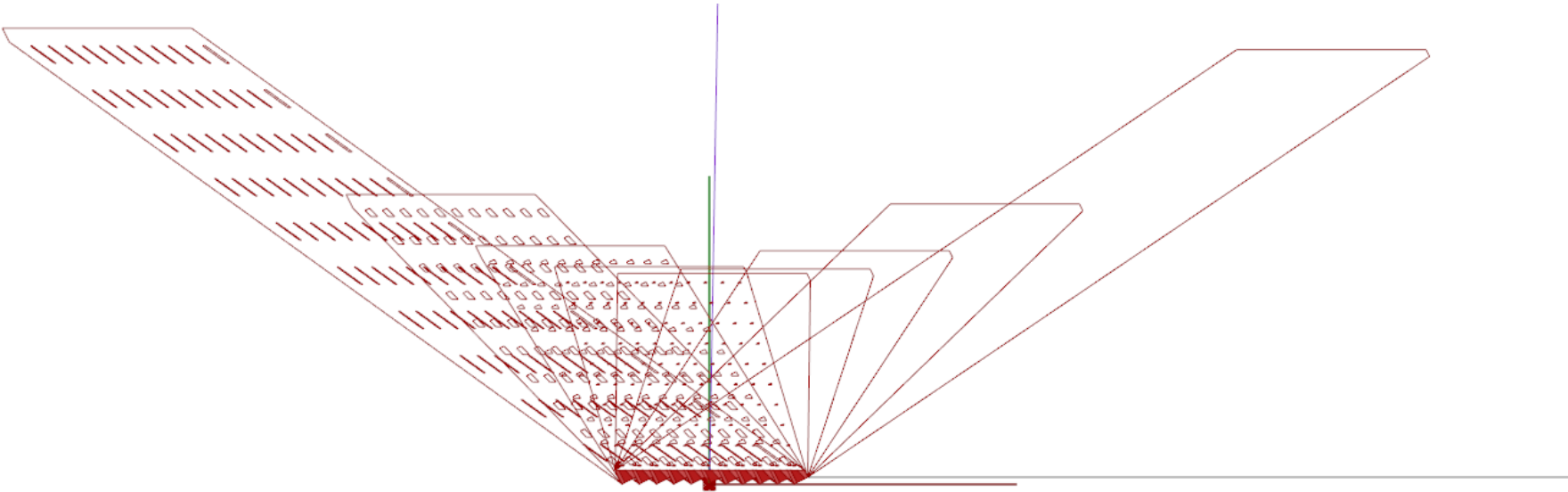

Shadow range

direct solar penetration : 7.10 am to 11.26 am

[fig. 59a]

Customization // Assembly : solar analysis

case A.

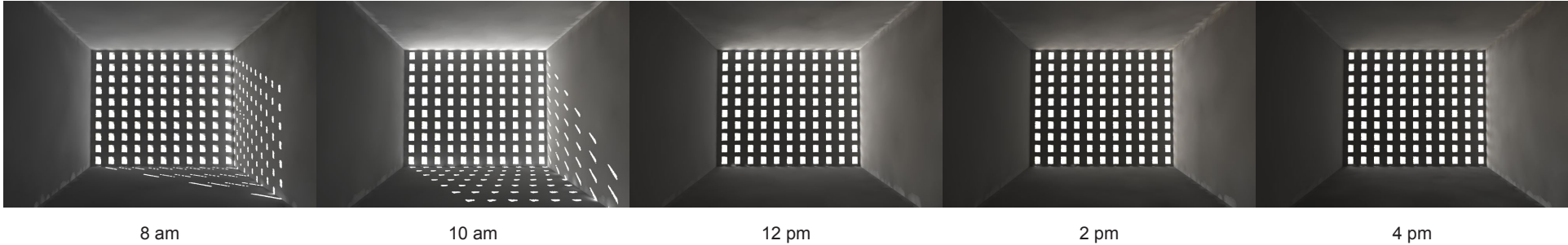

Radiance renderings

[fig. 60a]

# Customization // Assembly : solar analysis

## TEST 2

Location : New Delhi (28°36'50"N 77°12'32"E)

Day : Dec. 22 (Winter Solstice)

### case B.

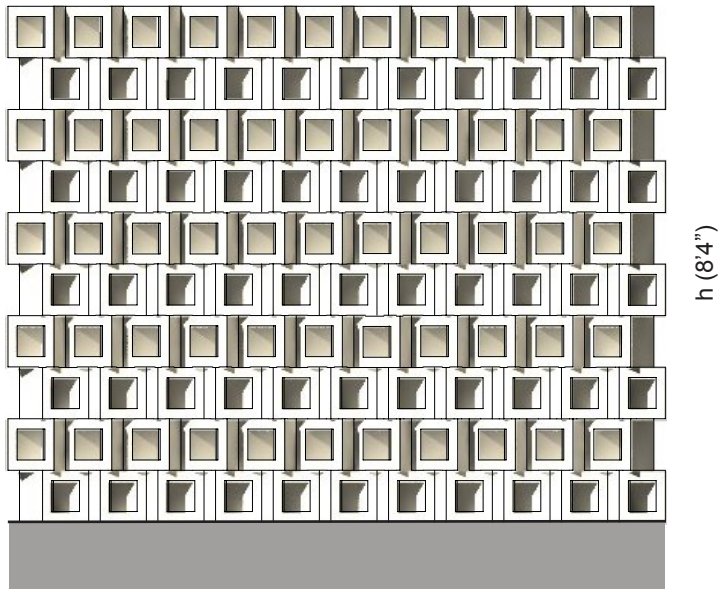

Elevation

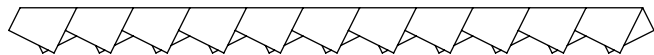

Plan

### block 7

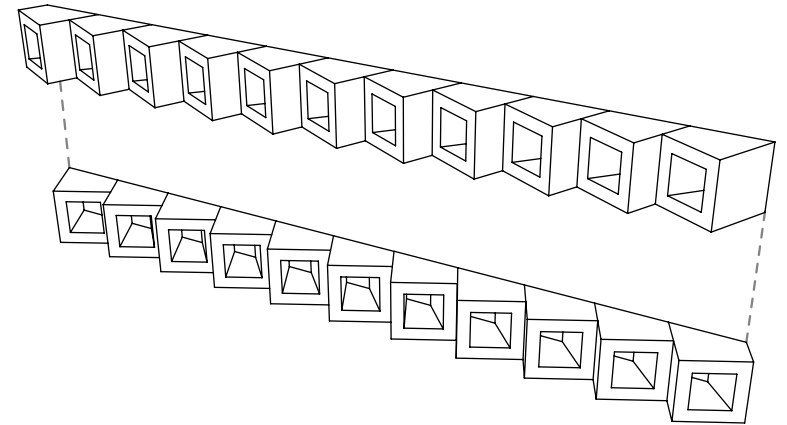
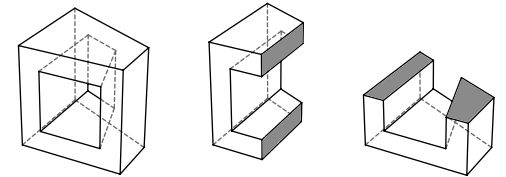

Stacking logic

[fig. 61a]



**Customization // Assembly : solar analysis**

**case B.**

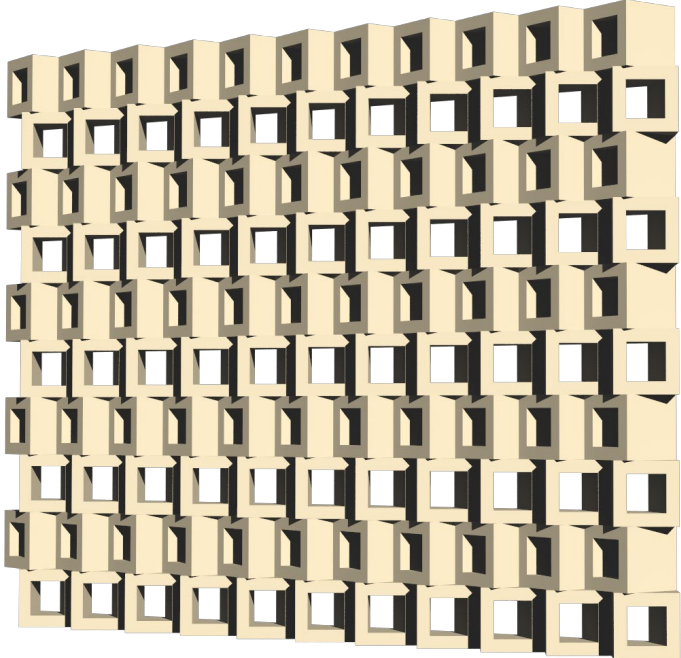

**Rendered view**

[fig. 62a]

case B.

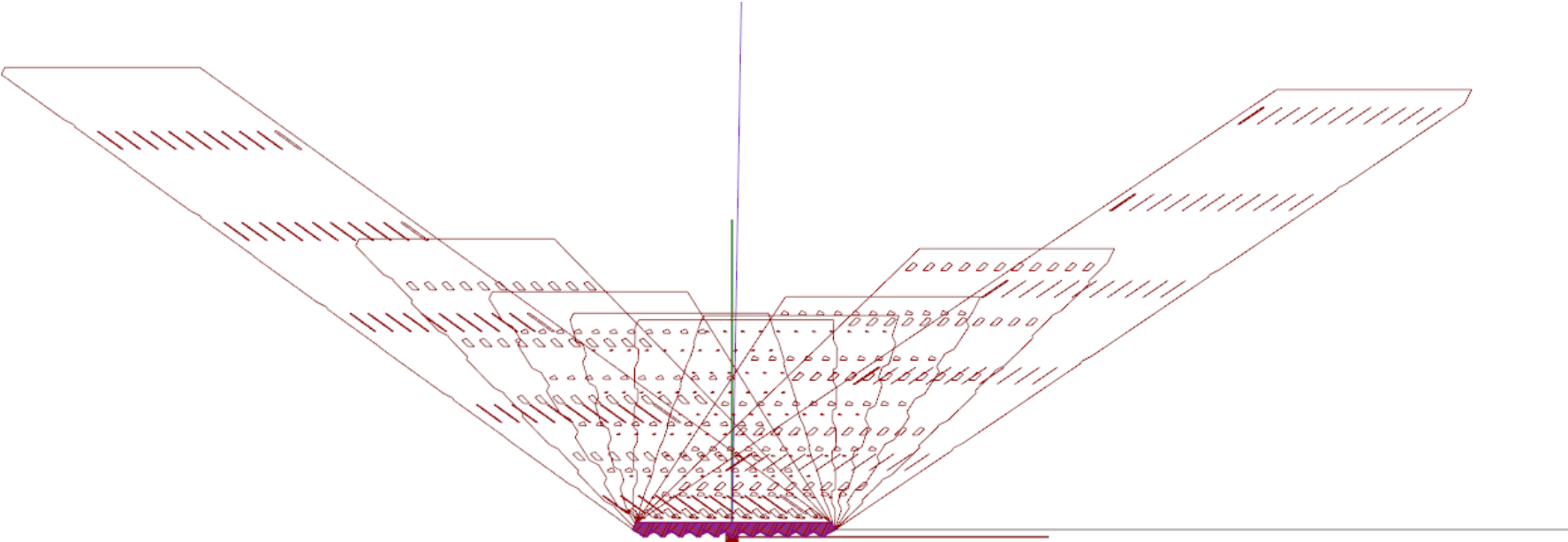

Shadow range

direct solar penetration : 7.10 am to 5.30 pm

[fig. 63a]

Customization // Assembly : solar analysis

case B.

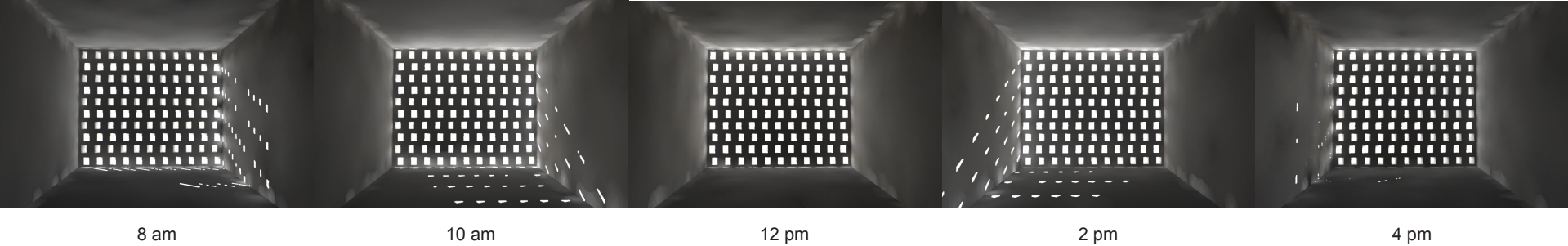

Radiance renderings

[fig. 64a]

# Customization // Assembly : solar analysis

## TEST 2

Location : New Delhi (28°36'50"N 77°12'32"E)

Day : Dec. 22 (Winter Solstice)

### case C.

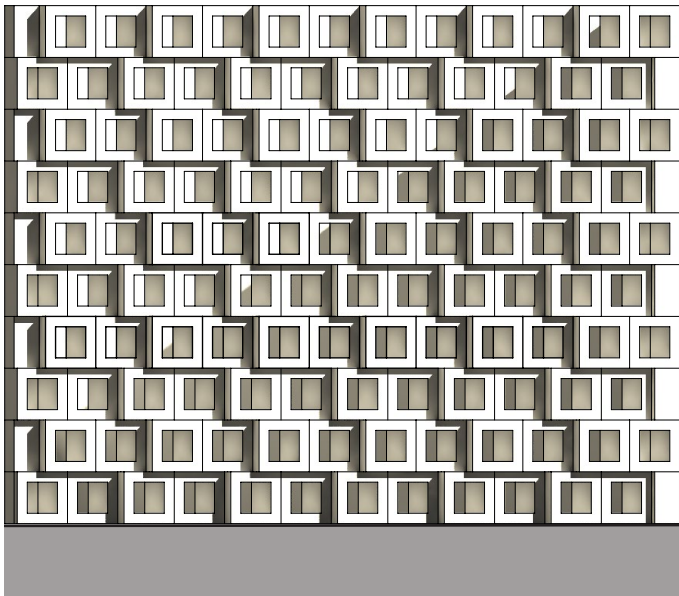

Elevation

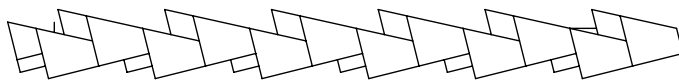

Plan

### block 7

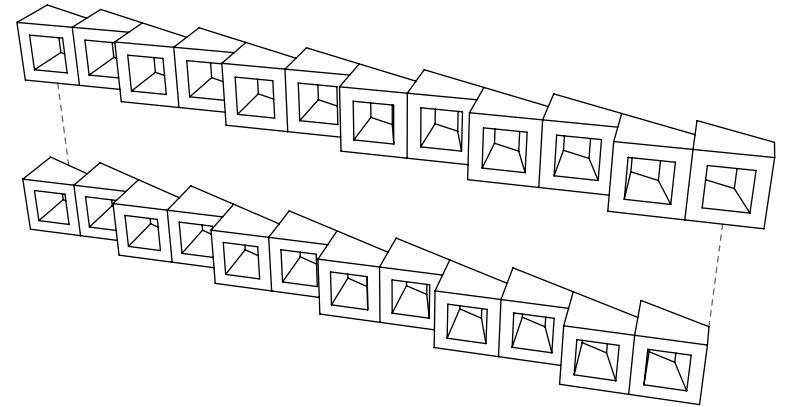
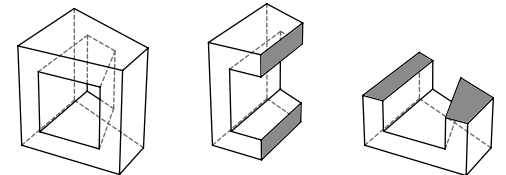

Stacking logic

[fig. 65a]



Customization // Assembly : solar analysis

case C.

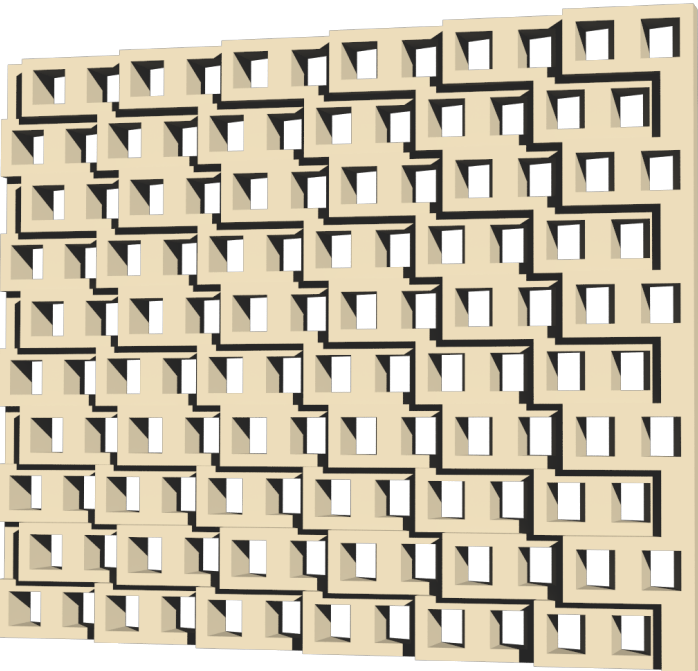

Rendered view

[fig. 66a]

Customization // Assembly : solar analysis

case C.

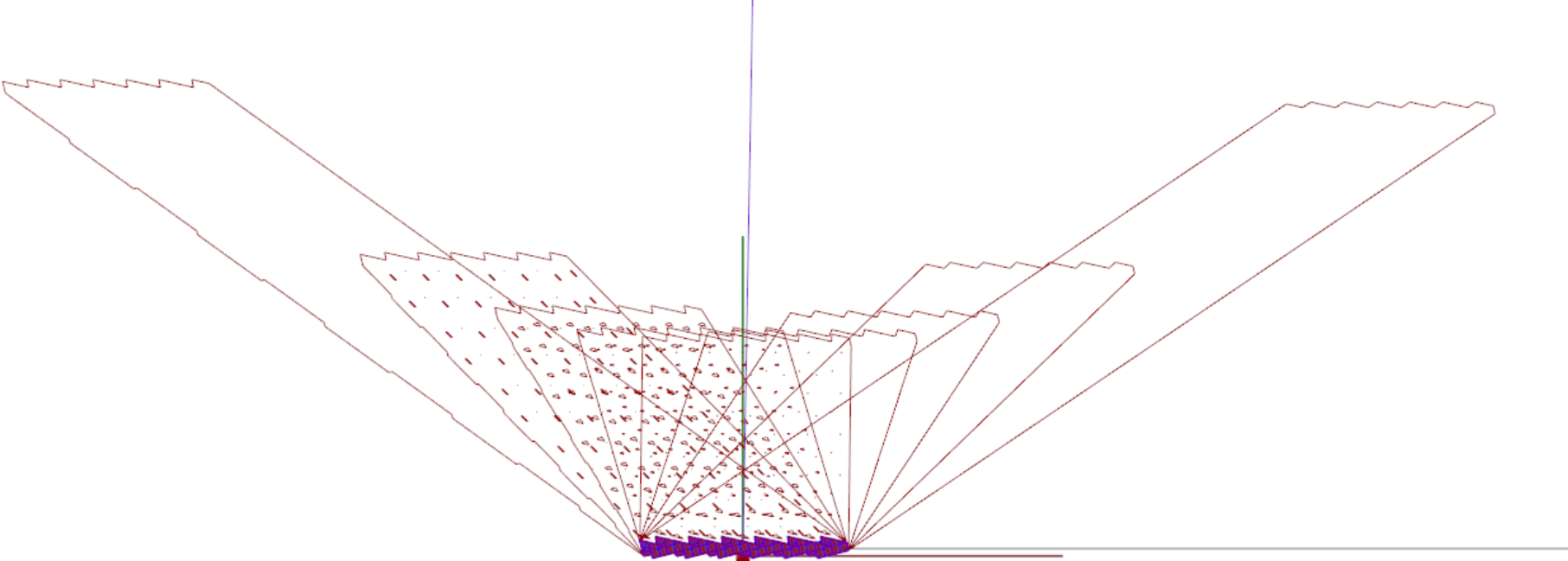

Shadow range

direct solar penetration : 9.18 am to 12.30 pm

[fig. 67a]

Customization // Assembly : solar analysis

case C.

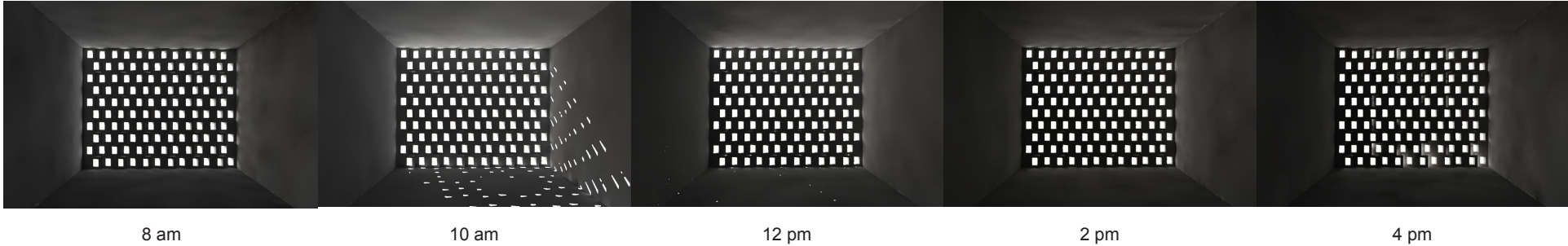

Radiance renderings

[fig. 68a]

# Customization // Assembly : solar analysis

## TEST 2

Location : New Delhi (28°36'50"N 77°12'32"E)

Day : Dec. 22 (Winter Solstice)

case D.

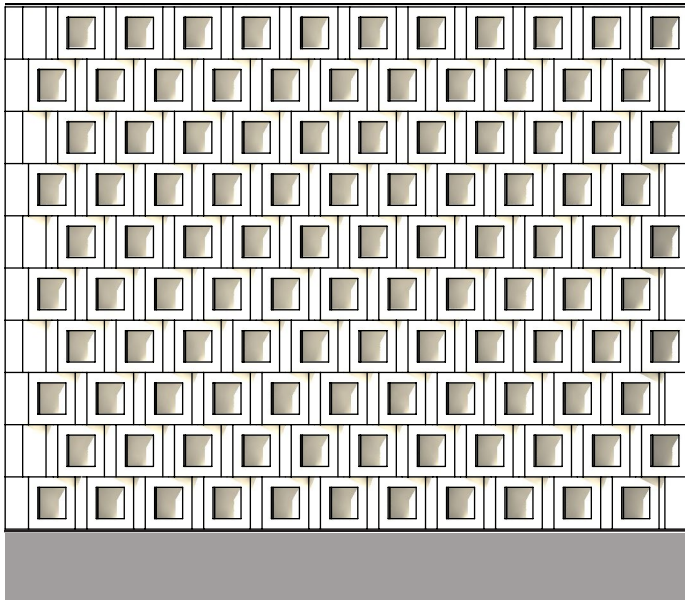

Elevation

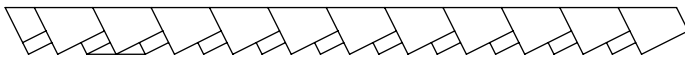

Plan

## block 7

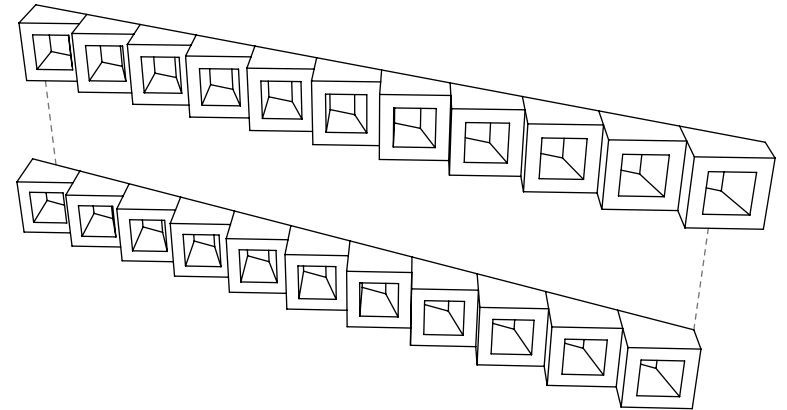
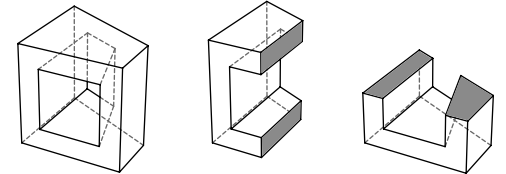

Stacking logic

[fig. 69a]



**Customization // Assembly : solar analysis**

**case D.**

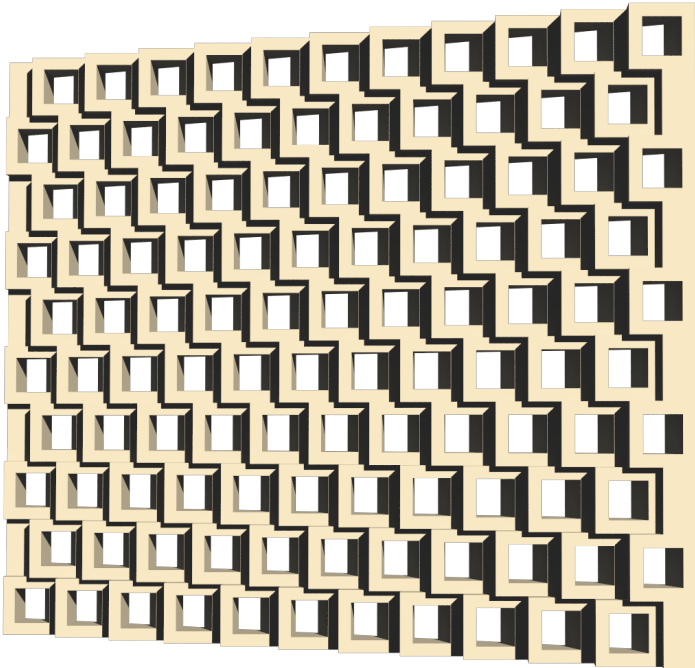

**Rendered view**

[fig. 70a]

Customization // Assembly : solar analysis

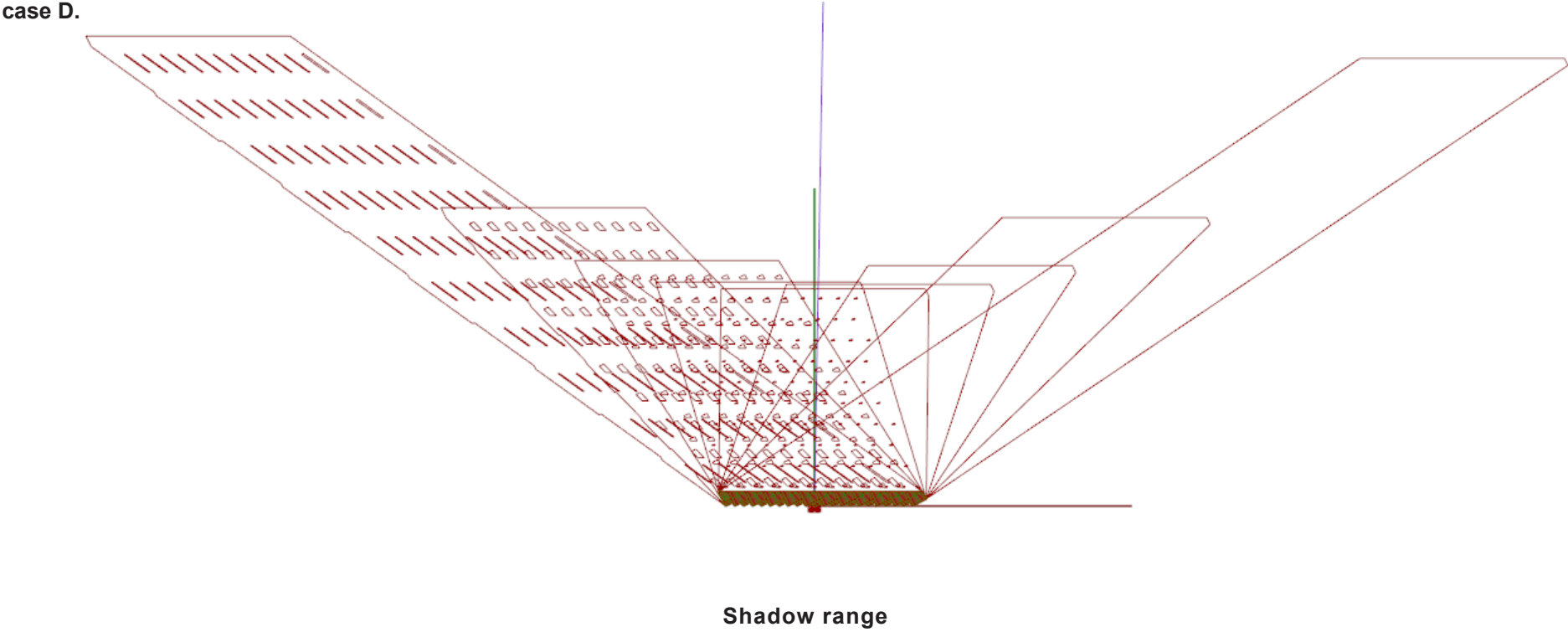

direct solar penetration : 7.10 am to 11.26 am

[fig. 71a]

Customization // Assembly : solar analysis

TEST 2

Location : New Delhi (28°36'50"N 77°12'32"E)

Day : Dec. 22 (Winter Solstice)

case E.

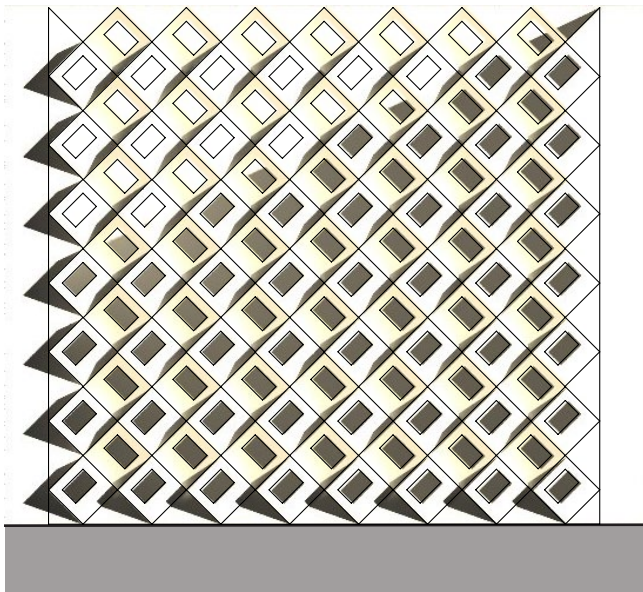

h (8'6")

Elevation

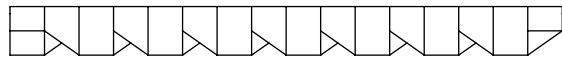

Plan

block 7

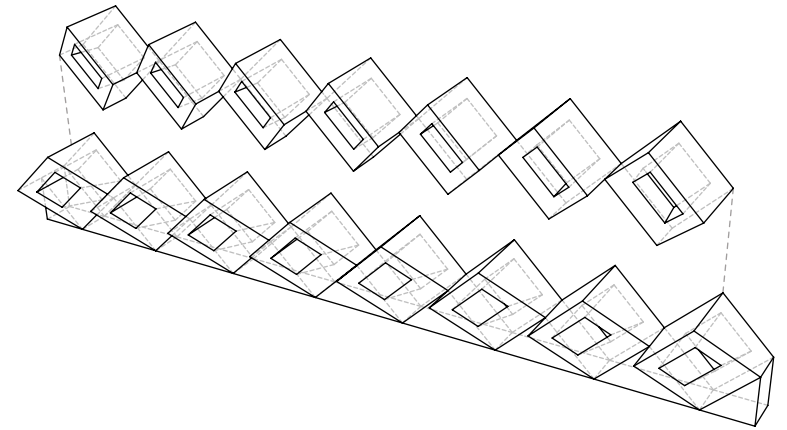
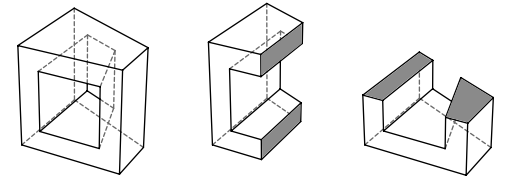

Stacking logic

[fig. 72a]



**Customization // Assembly : solar analysis**

**case E.**

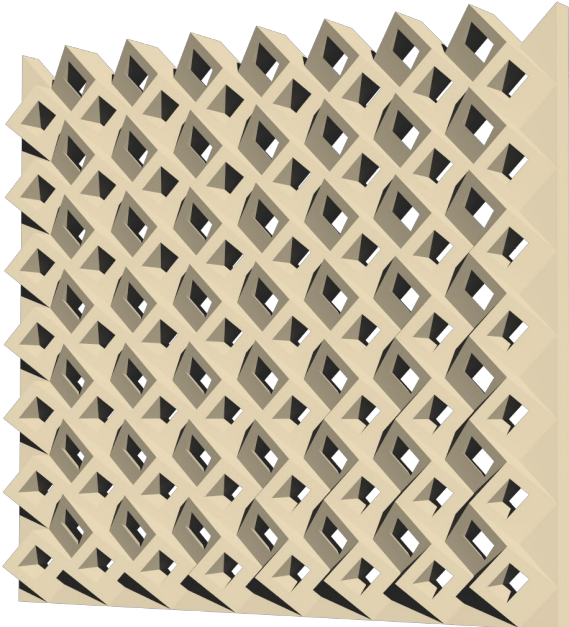

**Rendered view**

[fig. 73a]

Customization // Assembly : solar analysis

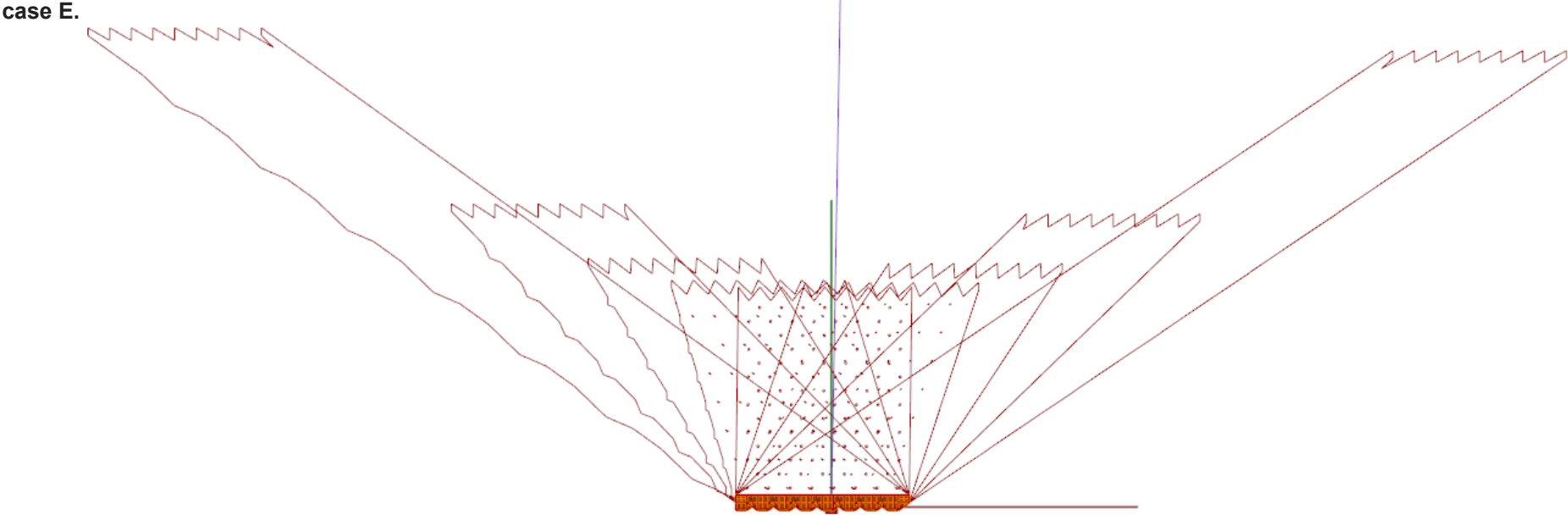

Shadow range

direct solar penetration : 11.26 am to 1.34 pm

[fig. 74a]

Customization // Assembly : solar analysis

case D.

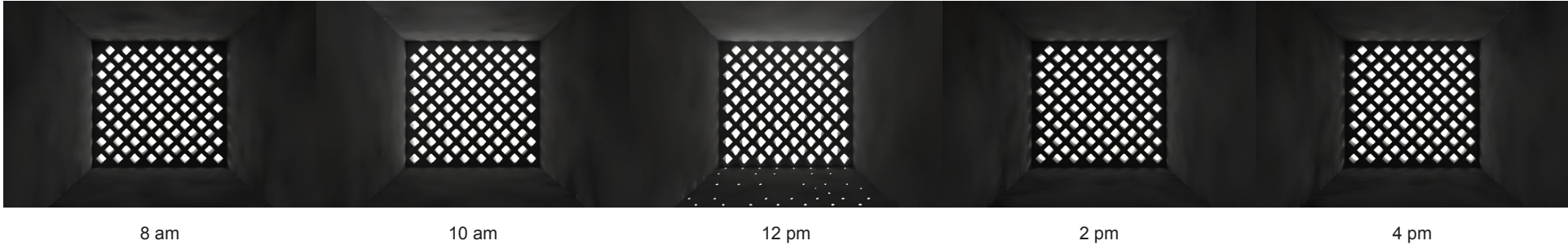

Radiance renderings

[fig. 75a]

## Customization // Assembly : solar analysis {observations}

The tests were performed with the facades facing south. These assemblies were generated using the same block but display a specific behavior with respect to block geometry and orientation. The block has an angular face chamfered at an angle of 30 degrees, and a tapered void.

In the first course of case A, the chamfered faces of all the blocks are aligned (refer pg. 57). The same course is stacked to create an assembly. This assembly only allows direct solar penetration from 7.10 am to 11.26 am (refer page 59). Radiance renderings display similar results.

The first course of case B is the same as first course of case A. The second course in this case, is a mirrored version of the first case. A stacked combination of these courses forms an assembly. This assembly allows direct solar penetration throughout the day, from 7.10 am to 4.46 pm (refer page 63). Radiance renderings display similar results.

In case C, a unit of two blocks is repeated to form the first course. The unit is formed by aligning the flat faces. The repetition happens by aligning the chamfered faces (refer page 65). The second course remains the same but is shifted by half a block. The solar penetration observed in this case is quite interesting. The assembly allows solar penetration from 9.18 am to 12.30 pm. The solar penetration observed in the cases discussed above was quite predictable. But, the solar penetration observed in case C can

only be analyzed using solar analysis tools such as Ecotect and Diva.

The first course in case D is the same as the first course in case A. The second course remains the same but is shifted by half a block. The results observed were very similar to those observed in case A. Radiance renderings display similar results.

In case E, the first course is generated by rotating the block by 45 degrees and in the second course, the block is rotated by 135 degrees (refer pg. 72). The assembly allows solar penetration from 11.26 am to 1.34 pm.

Change in orientation of the blocks and their pattern of assembly can generate a wide range of unique assemblies displaying changes in behavior with respect to solar position.

## Hi - Lo

### Lo - tech production : strategies

The next phase of inquiry during the course of research was to identify suitable fabrication strategies for the block geometries.

In a completely automated production environment, data from a Computer Aided Design system is digitally translated to machine language for Computer Aided Manufacturing. This allows extremely precise production of a variety of parts with minimal error.

In a low tech environment, the production is either partially mechanized or fully manual. In either case, specific data is required for production of parts. In the case of brick production, the dimensions of the mold required to cast bricks governs the size of the brick. In the case of CINVA ram or its versions (like AURAM), its the size of the mold and inserts that govern the production of customized compressed interlocking blocks.

Within the context of this research (Hi-Lo), for the production of customized blocks, information such size of blocks, size and shape of voids and chamfer angles is needed. The GH definition that is designed to generate digital geometry for visualization and analysis, enable the extraction of the information required for fabrication. This attribute of generative modeling aids customization, even if the flow of information is discontinuous.

A standard mold can have a set of inserts to control void geometry. The same mold can be tilted at different angles to generate chamfered faces. Vertical inserts of varying thickness can be used to control the size of the blocks using the same mold.

The next section describes the fabrication strategies devised for production of customized blocks.

# Hi - Lo

Lo - tech production : strategy 1 // casting

information flow

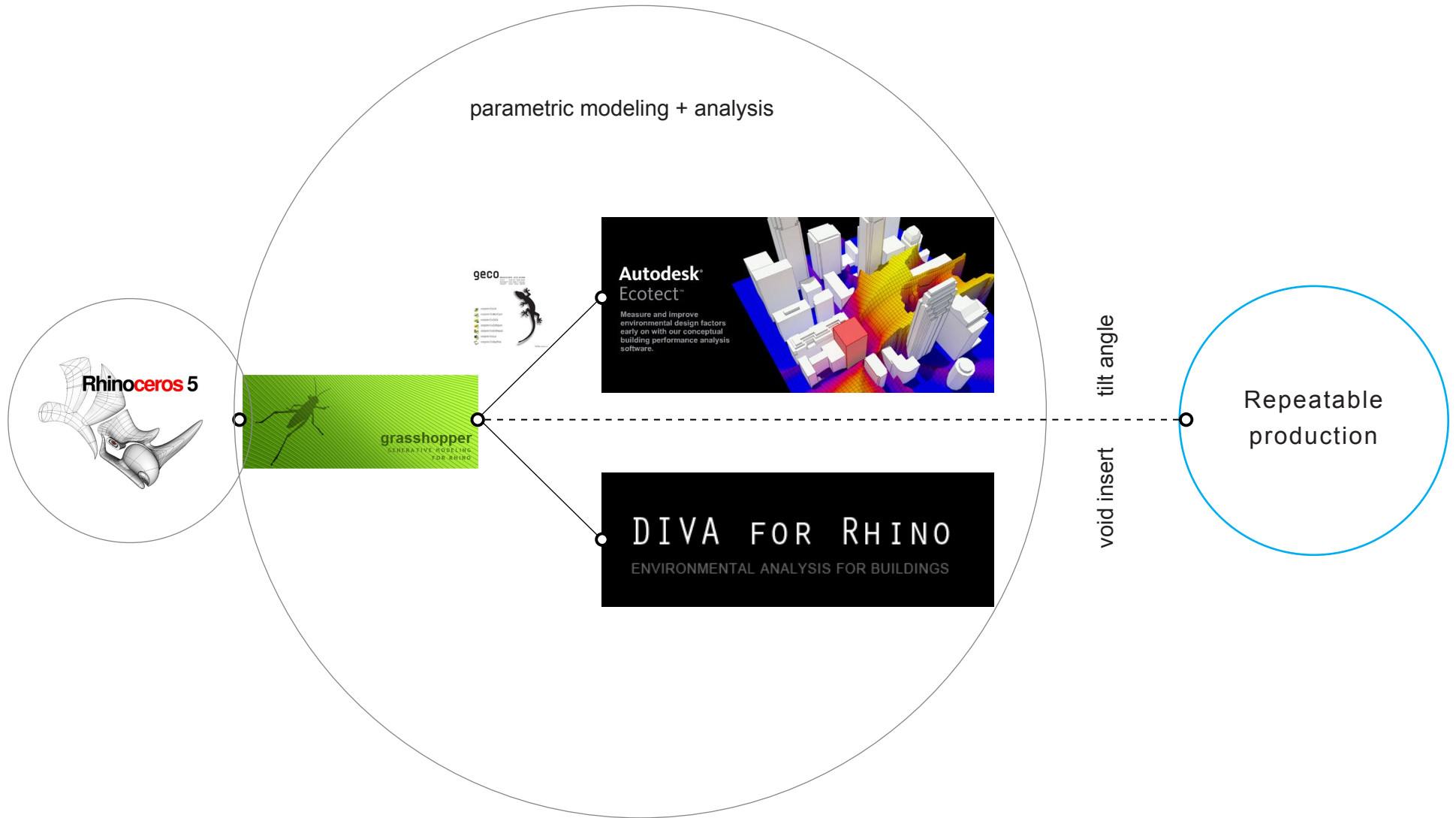

## Customization // production : low-tech {strategy 1}

### process

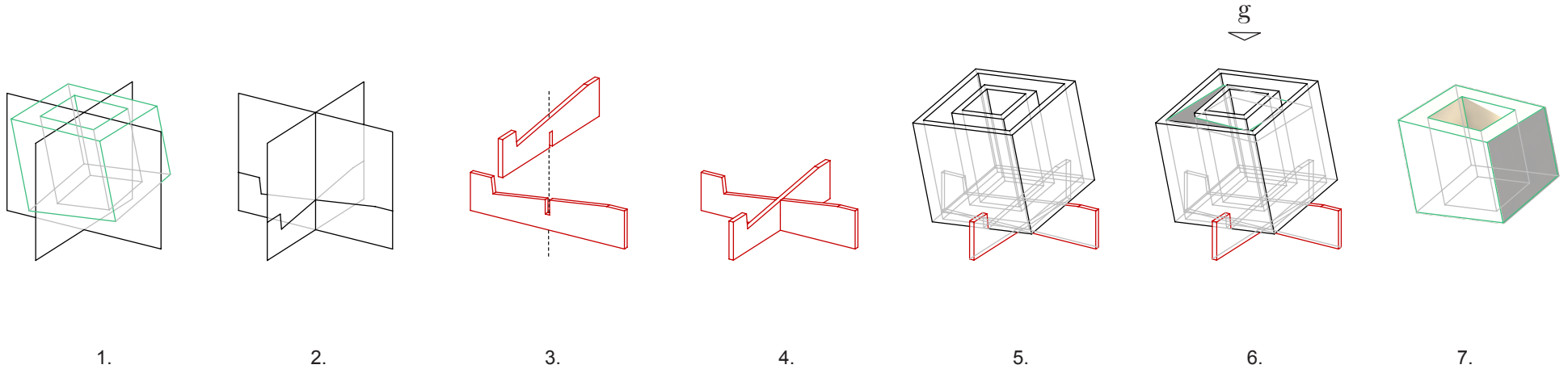

[fig. 79a]

1. geometry generated in Grasshopper
2. tilt angles extracted to generate cut profiles
- 3 & 4. set of interlocking keys
5. tilted mold assembly
6. moldable composite poured
7. cast ready

As shown in steps 3 and 4, a set of interlocking keys can be used to maintain the tilt angle of the mold.

The tilt angles are extracted through the GH definition to generate cut profiles for fabricating the interlocking keys.

The information required to generate cut profiles for making the keys can be extracted from the same GH definition that generates block geometries for solar analysis. The flow of information is not fully discontinuous, which makes the production process partially automated.

Customization // production : low-tech {strategy 1}

process + parts

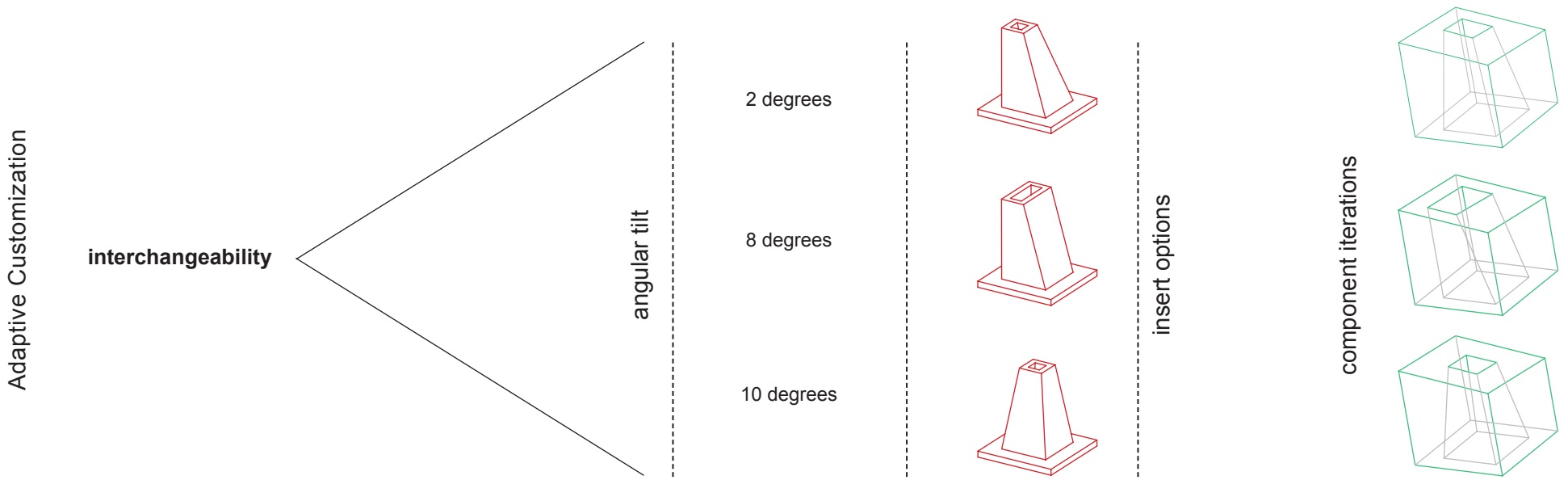

[fig. 80a]

The diagram shown above suggests that a combination of tilt angles and insert options can help produce different block geometries using the same mold.

The GH definition provides the ability to generate block geometries from a fixed number of insert options and a fixed spectrum of tilt angles. The orientation of the insert, during the process of casting, is an addition to the range of parameters that broaden the spectrum of variation in this low-tech production mechanism.

Customization // production : low-tech {strategy 1}

process + parts

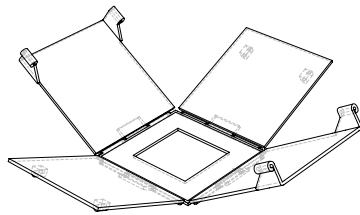

A. hinged steel plates

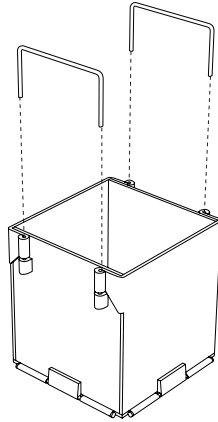

B. locking pins

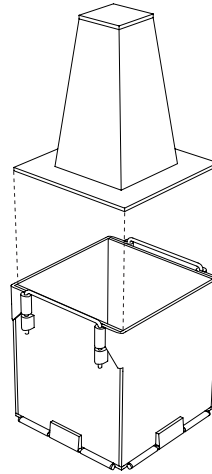

C. void insert

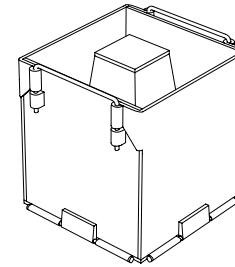

D. mold assembly

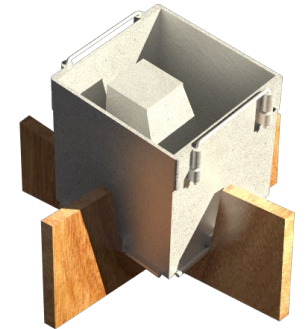

E. tilted mold assembly

Since steel is used for making form-work for cast-in-place concrete, the mold for casting poured-earth is proposed to be made out of steel.

A hinged assembly of steel plates is designed as shown in fig. A.

A set of locking pins (as shown in fig. B) keep the plates locked in place.

Different void inserts can be used to control the shape of void.

Fig. E shows the mold assembly resting on a set of interlocking keys that help maintain the tilt angle.

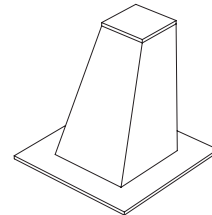
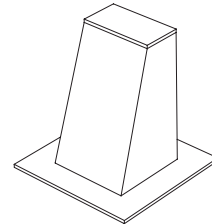
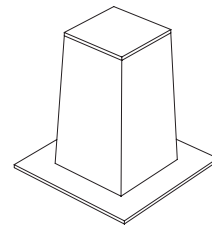

insert options

Customization // production : low-tech {strategy 1}

process + parts

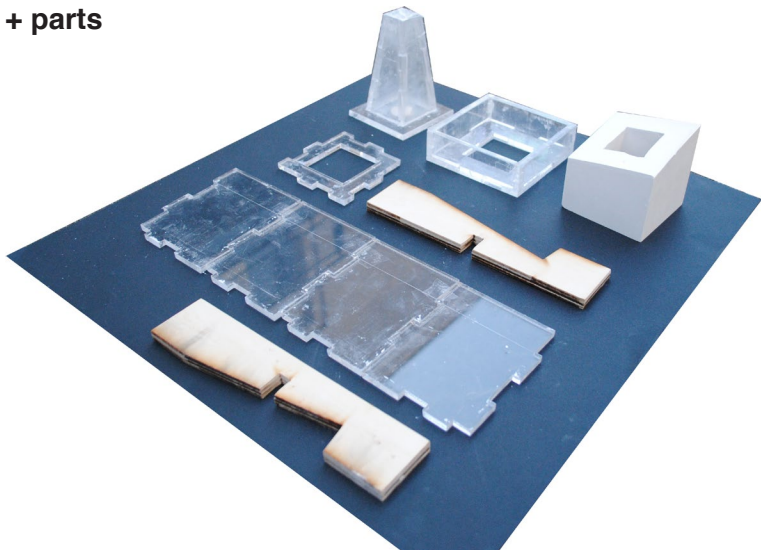

scaled prototype

A mold measuring 3.5" in length, breadth and height was designed to cast scaled prototypes. The mold and a tapered insert were modeled in Rhinoceros 5.0 and made out of plexi-glass, fabricated using a laser cutter.

The profile of each interlocking key has a slope of 5 degrees. The keys were modeled in Rhinoceros 5.0 and were made out of 1/4" bass wood . The profiles were cut using a laser cutter.

Hydrocal was a used as a composite to cast the test pieces.

mold {kit of parts} + cast

[fig. 82a]

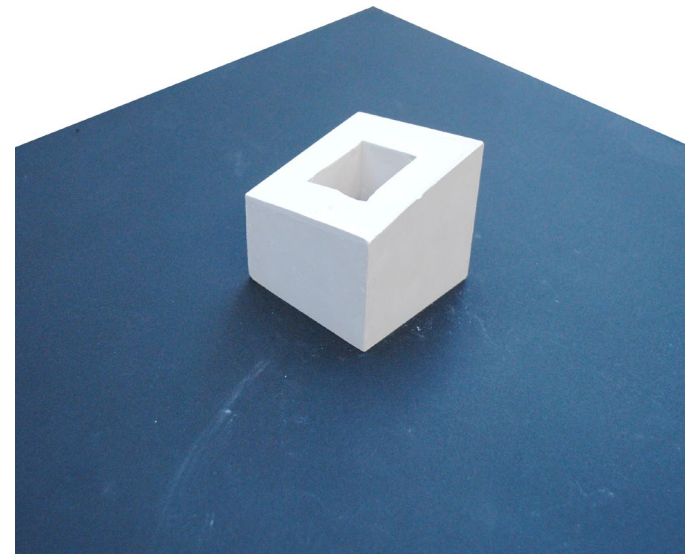
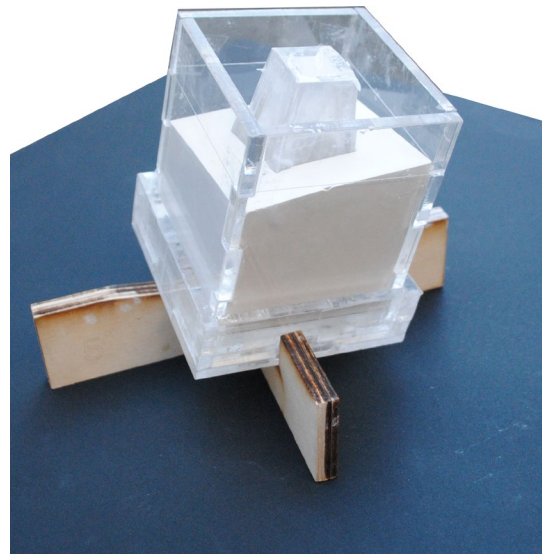
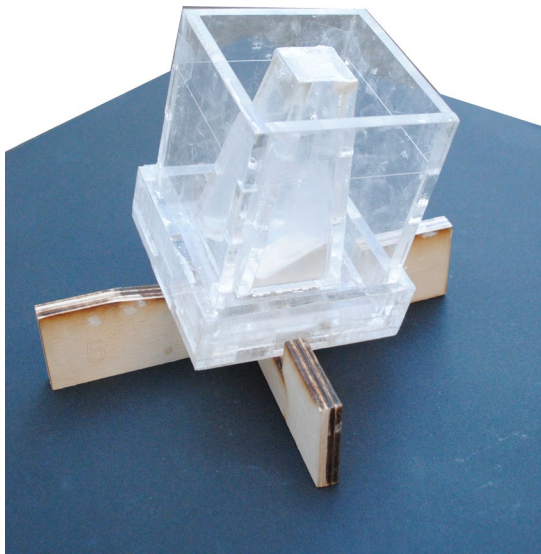

A. tilted mold assembly

B. composite {hydrocal} poured

C. cast

[fig. 82b]

Customization // production : low-tech {strategy 1}

assembly iterations

A series of different assemblies were generated using twelve identical blocks. Five iterations have been cataloged.

ITERATION A



SIDE 1



SIDE 2

[fig. 83a]

ITERATION B

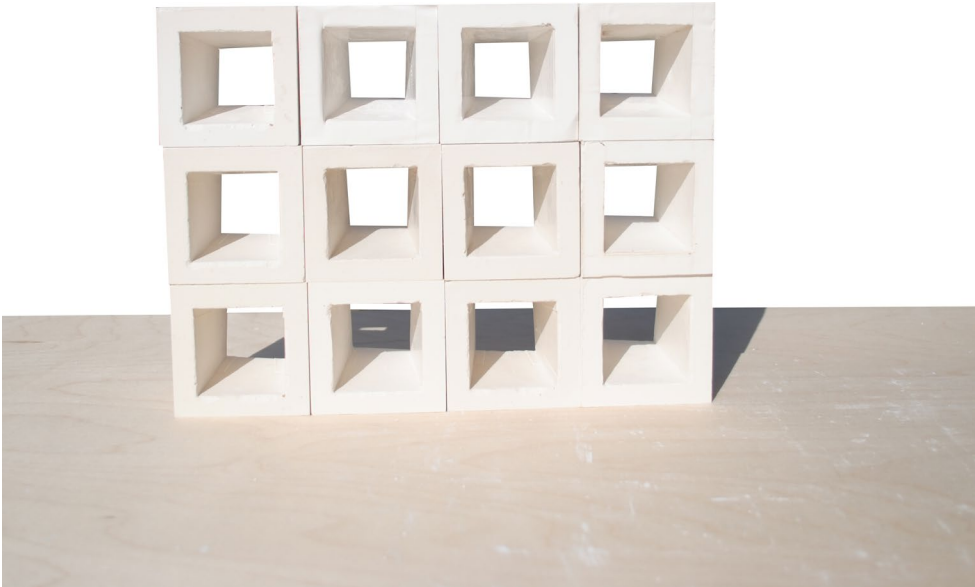

SIDE 1



SIDE 2

[fig. 84a]

ITERATION C

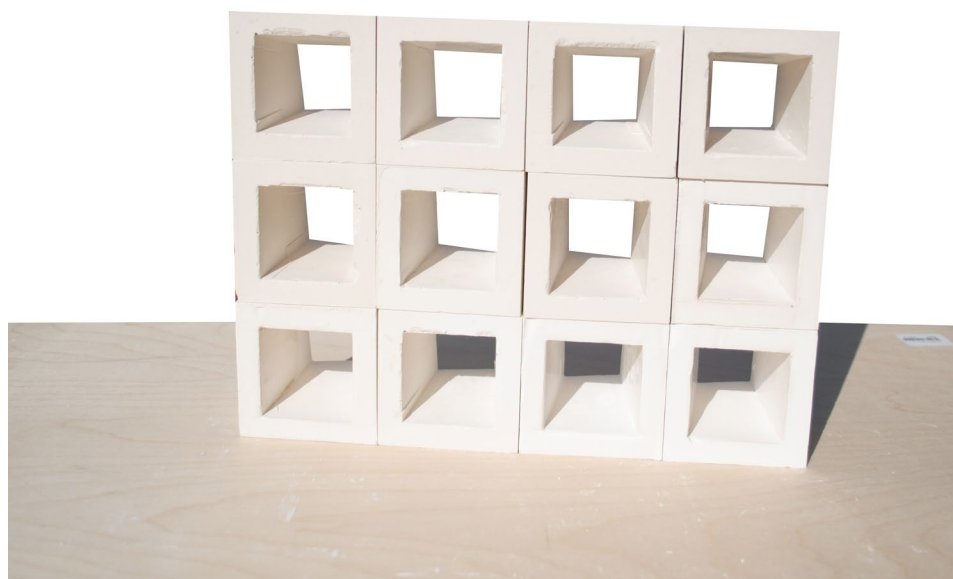

SIDE 1



SIDE 2

[fig. 85a]

ITERATION D

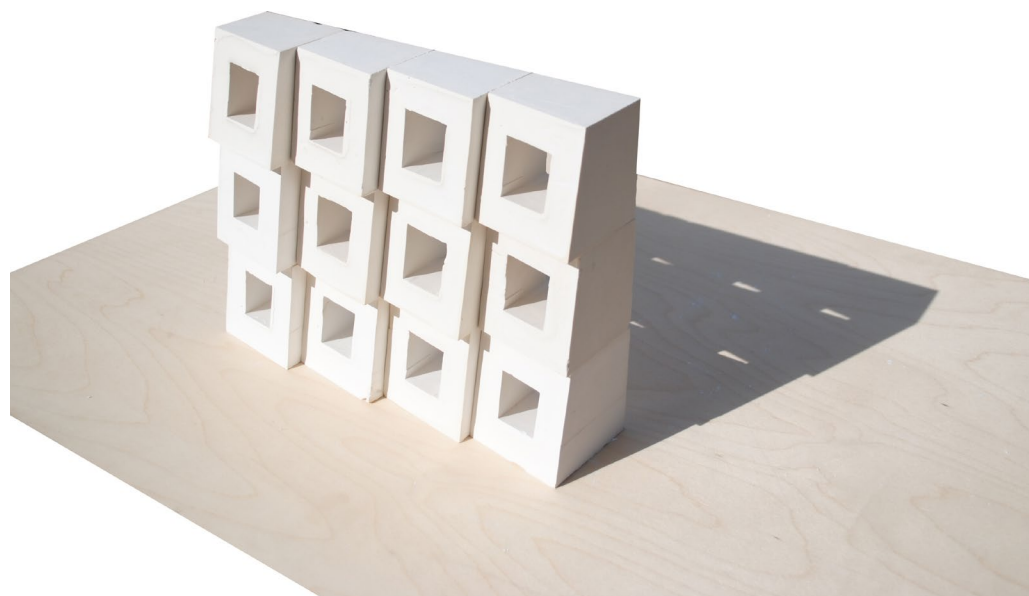

SIDE 1



SIDE 2

[fig. 86a]

ITERATION E



SIDE 1

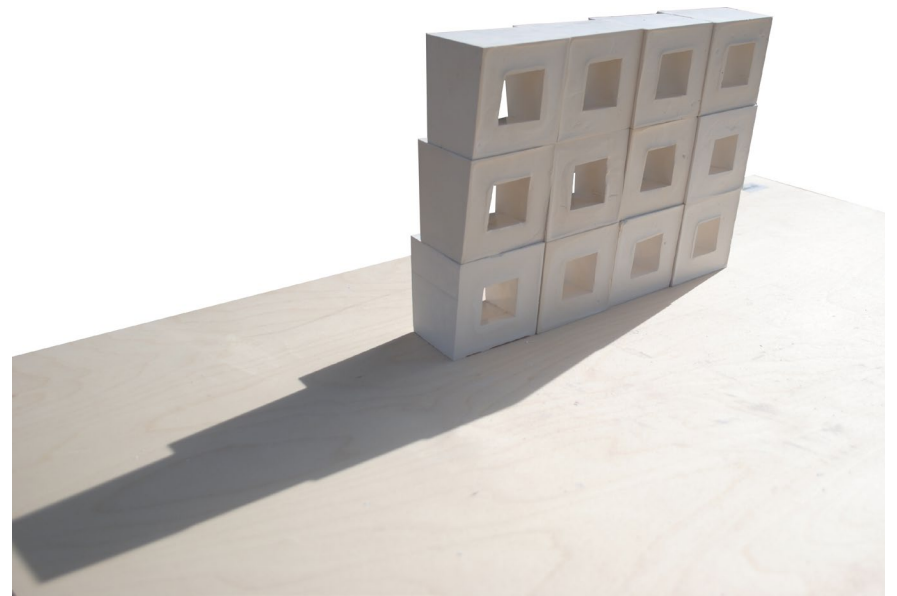

SIDE 2

[fig. 87a]

## Hi - Lo

Lo - tech production : strategy 2 // compressed stabilized earth blocks

precedent



The CETA-RAM is a manually operated block press, developed by the Roberto Lou Ma just after the February 1976 Guatemalan Earthquake. It was designed specifically for the production of hollow soil-cement building blocks. The hollow blocks are intended for use in reinforced masonry for low cost earthquake resistant housing.

The CETA-RAM is a modified version of the well known CINVA-RAM. The name CETA-RAM honors the Centro Experimental de Tecnología Apropiaada (CETA), where it was developed, and the Chilean engineer Raúl Ramírez, creator of the CINVA-RAM.

A revised version (Hi-Lo RAM) of the CET-RAM has been proposed to produce the block geometries produced in GH. The modeling process of the Hi-Lo RAM started in Rhinoceros 5.0 from set of drawings of the CETA-RAM obtained from the following source :

<http://biorealis.com/OMV/deeptech/wp-content/uploads/2012/09/CETA-RAM-Block-Press.pdf>

The parts were individually exported as Rhinoceros 4.0 geometry. And were imported in Solidworks to create an assembly. The assembly was tested via motion simulation and collision detection in Solidworks.

fig. 88a.

# Hi - Lo

Lo - tech production : strategy 2 // compressed stabilized earth blocks

information flow

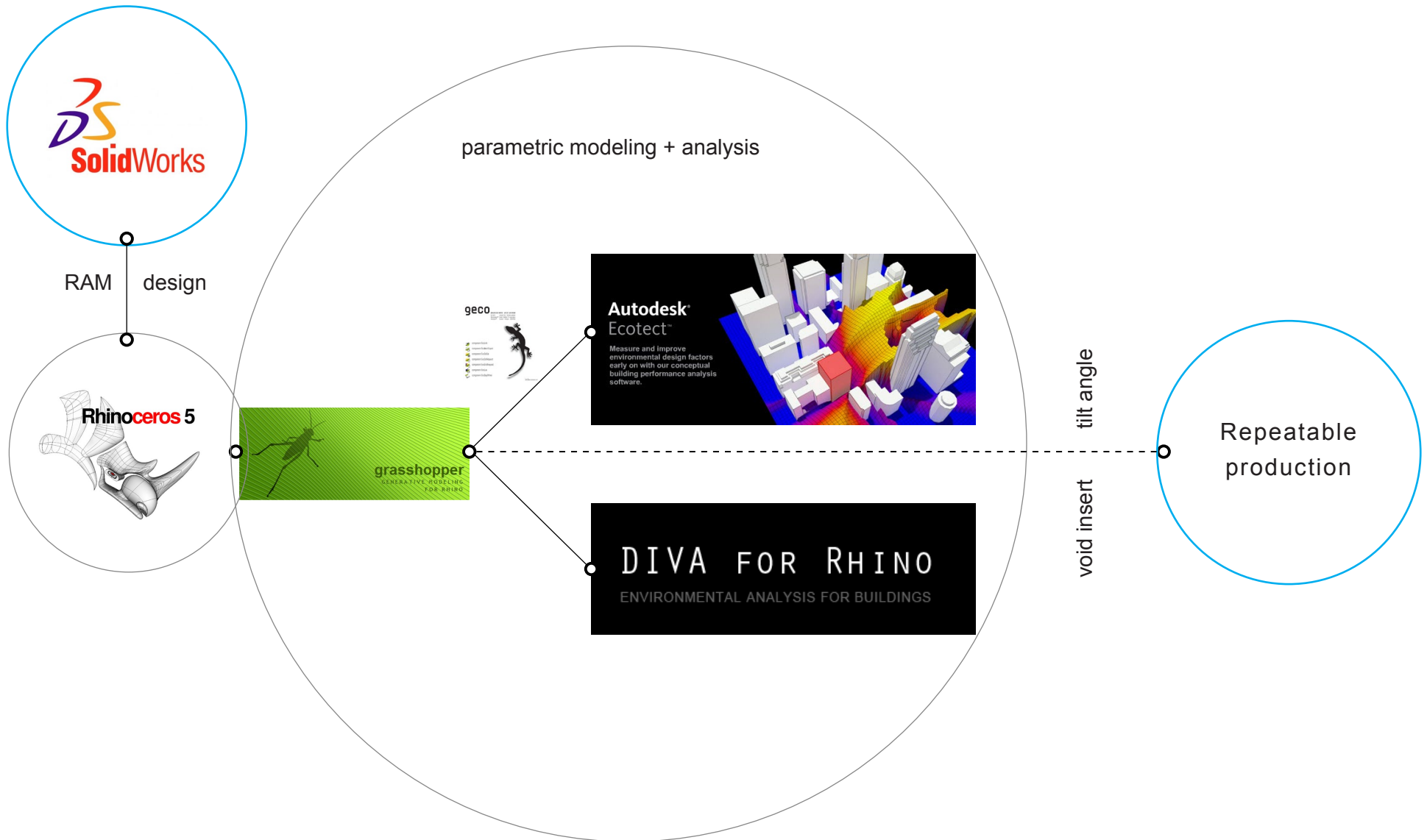

parts

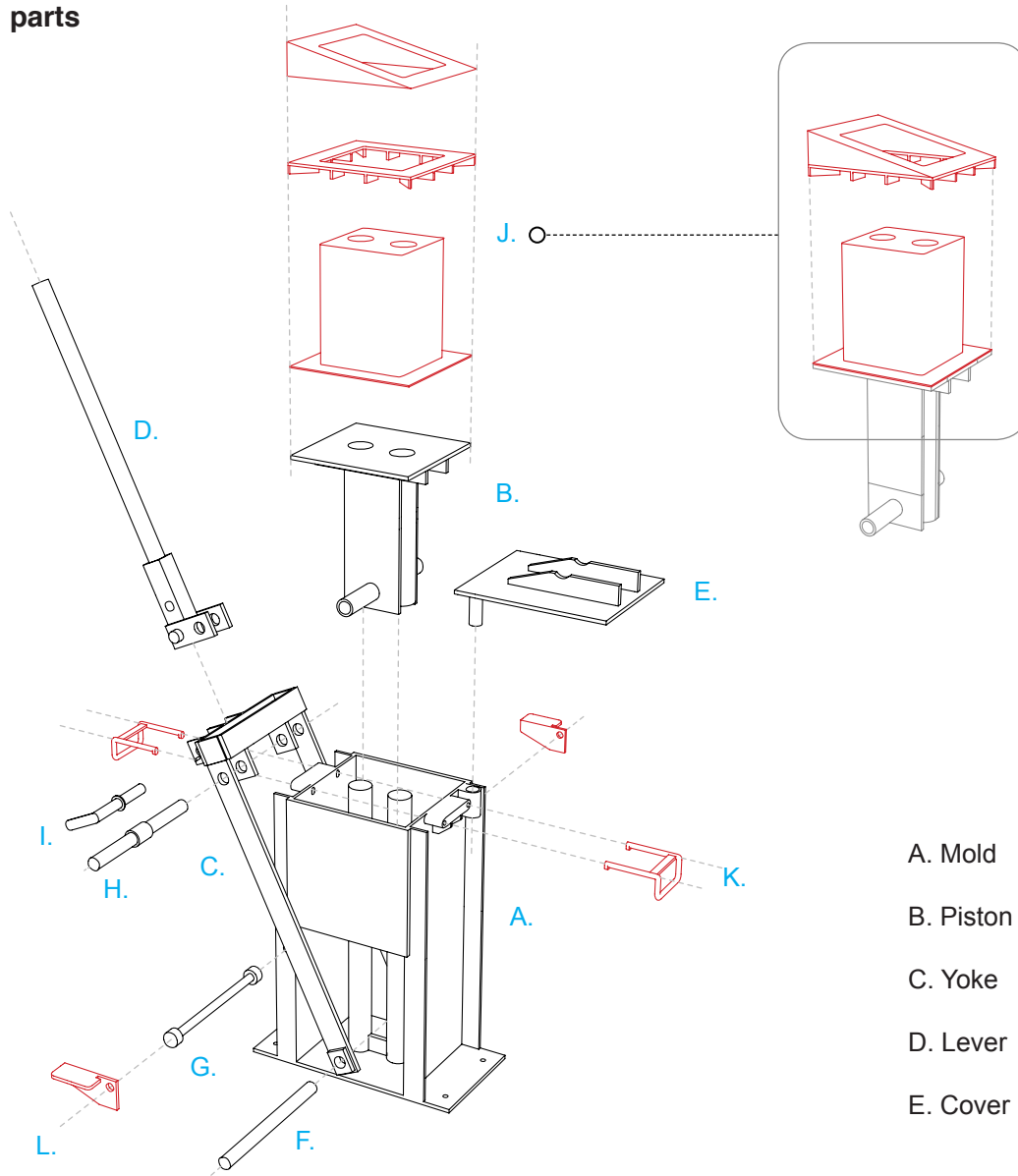

- A. Mold
- B. Piston
- C. Yoke
- D. Lever
- E. Cover plate

The parts shown in black are parts that belong to the CETA-RAM. The shape and sizes of those parts have been slightly modified to satisfy the production requirements of the Hi-Lo blocks.

The parts shown in red are additions to the existing design. Part J. is a combination of -

1. Wedge piece - that controls the chamfer angle of the block.
2. Separator plate.
3. Void insert
4. Base plate

The wedge piece is bolted to the separator plate. The void insert is welded to the base plate. And the base plate is bolted to the piston

- F. Pin 1
- G. Pin 2
- H. Pin 3
- I. Pin 4
- J. Void insert {assembly}
- K. Separator pins
- L. Yoke supports

[fig. 90a]

process

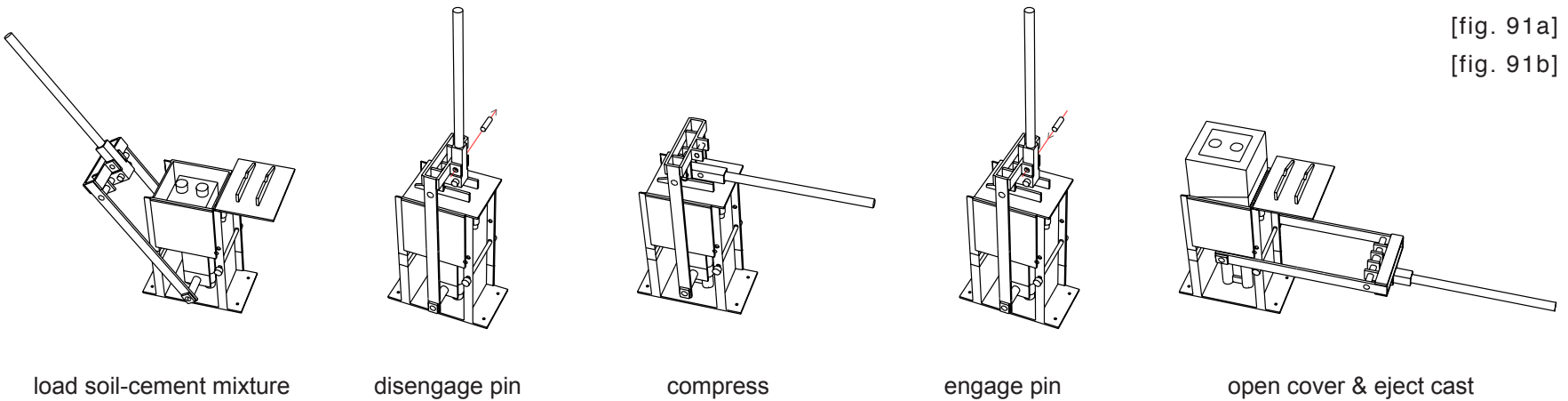
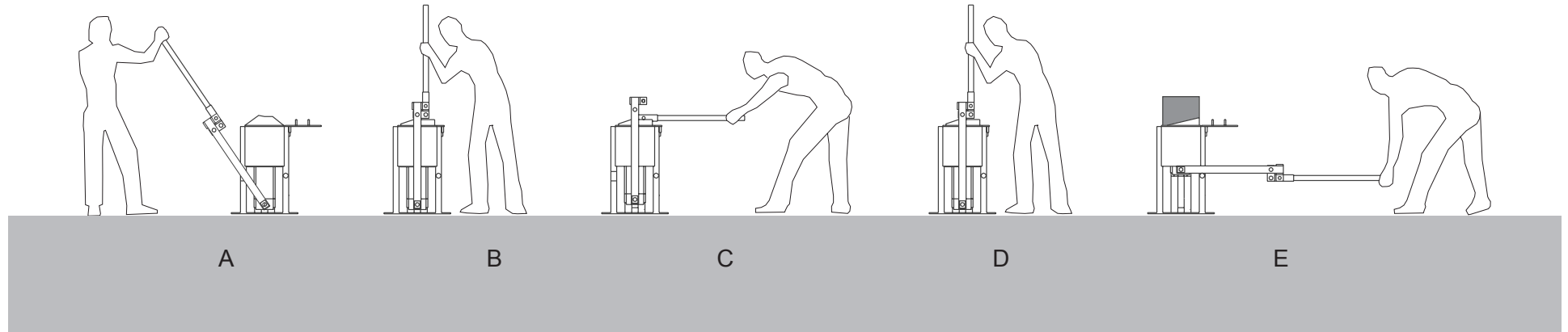

[fig. 91a]  
[fig. 91b]

The first step in the process (A) is to open the cover and load the soil-cement (stabilized earth) mixture. The yoke and the lever arm are connected through a hinge. An extra pin, if engaged, lock the position of the lever allowing the yoke and lever arm to act as one entity. In step B, the pin is disengaged so that the lever arm can be pressed in one direction as shown in step C. This action compresses the piston which in turn compresses the soil-cement mix. In step D, the pin is engaged, the cover is opened, and lever arm is pushed in the same direction as shown in step E. This action pushes the piston upwards, and the cast is ejected.

parts

Adaptive Customization

interchangeability

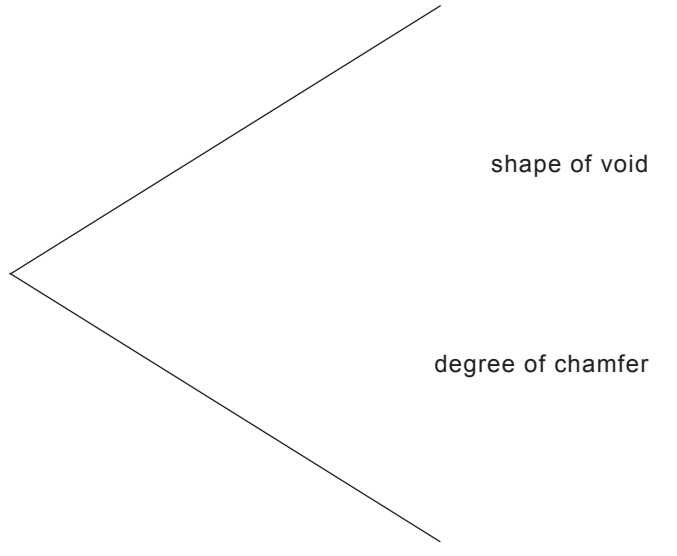

insert options

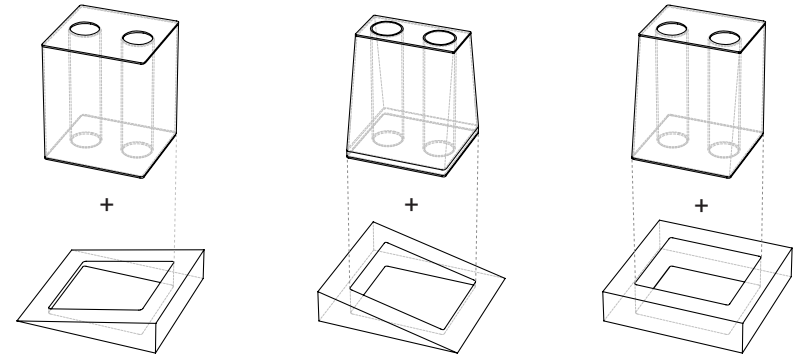

[fig. 92a]

A combination of wedge pieces and insert options can help produce different block geometries.

The GH definition provides the ability to generate block geometries from a fixed number of insert options and wedge pieces. The orientation of the insert, during the process of casting, is an addition to the range of parameters that broaden the spectrum of variation in this low-tech production mechanism.

component iterations

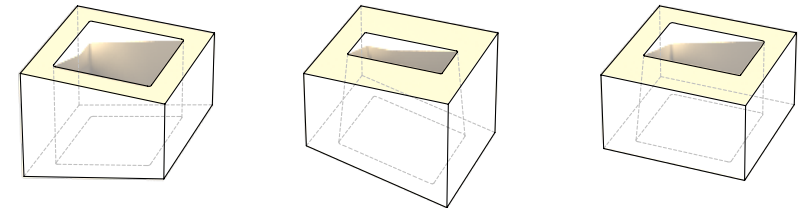

[fig. 92b]

## RAM assembly

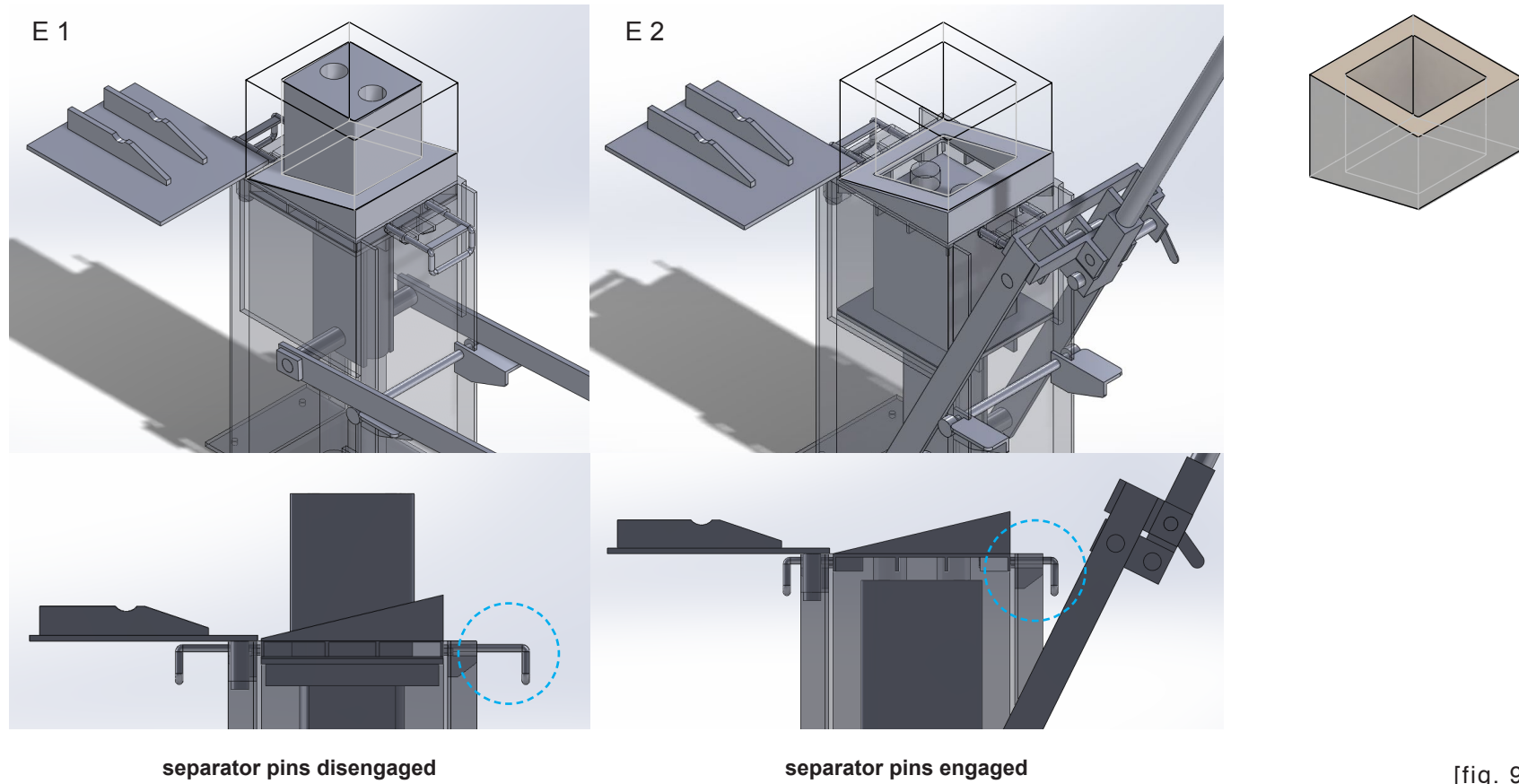

As the yoke rests on the yoke supports (refer diagram on page 90) while ejecting the cast, as explained in step E on page 91, the separator pins are engaged. The wedge piece and the separator plate will rest on the pins and will get separated from the void insert. As the pressure on the lever arm is released gradually, the void insert moves down with the piston (step E1). The cast is ready to be moved and left for curing.

## Hi - Lo

### Conclusion

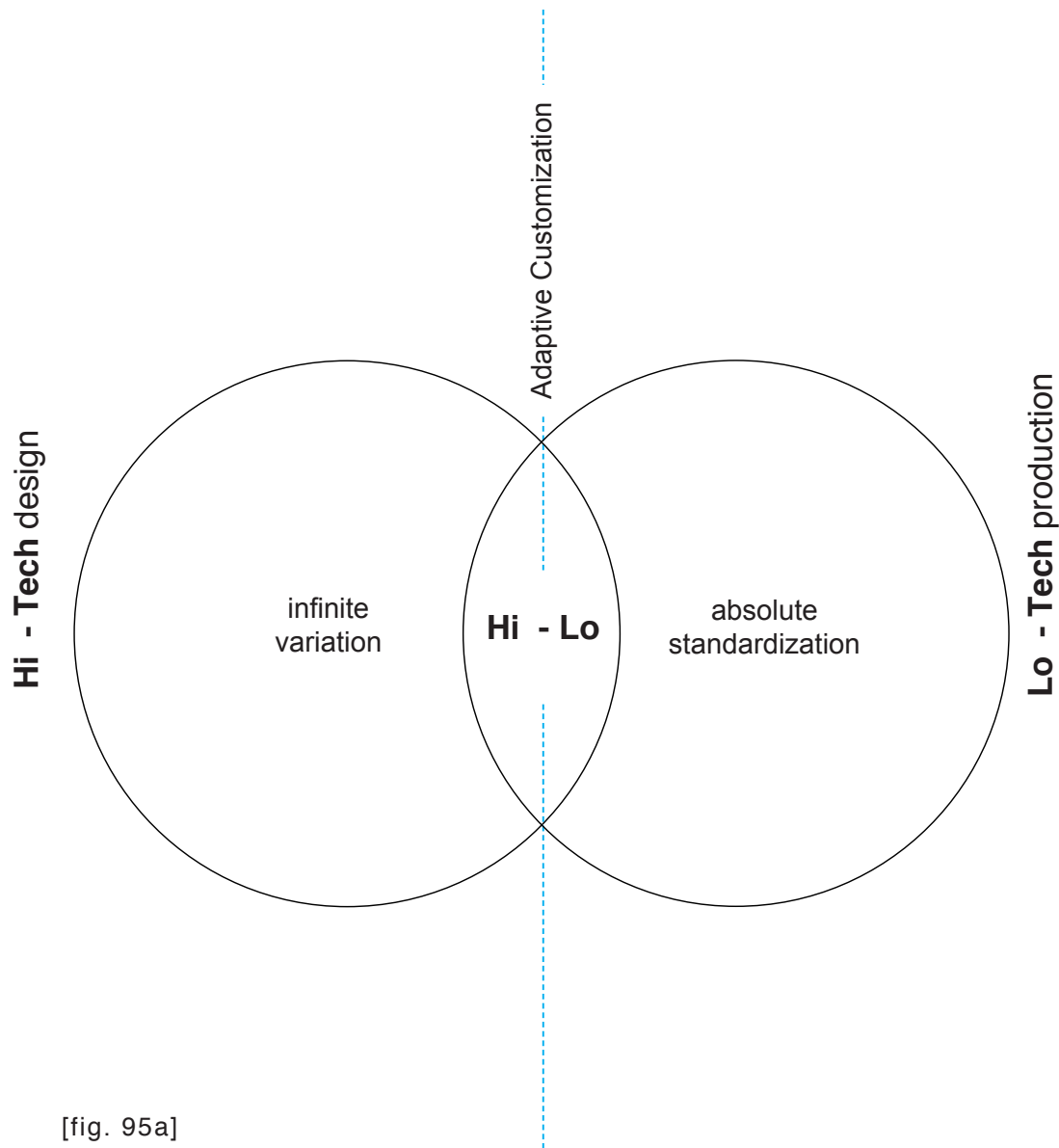

[fig. 95a]

This exploration asserts that low-tech production techniques can be given a new life by integrating high-tech tools in the design process. Simple yet informed adjustments to a repeatable manufacturing mechanism can facilitate the production of variation generated by high-tech design tools.

The preliminary solar studies indicate that the variable block geometries not only create visual interest when assembled, but also contribute towards performative effects in an architectural setting. There are several other aspects such as air flow, visibility (privacy), thermal performance etc. that need to be explored.

**Hi-Lo** is situated at the intersection of absolute standardization and infinite variation. It is a form of adaptive customization as defined by James Gilmore and Joseph Pine. In such a system or a product, the range of customization is defined by the designer or a manufacturer. A swivel chair is a good example of such a system. Thus, Hi-Lo offers the possibility of generating (digitally) and producing (physically) informed variation.

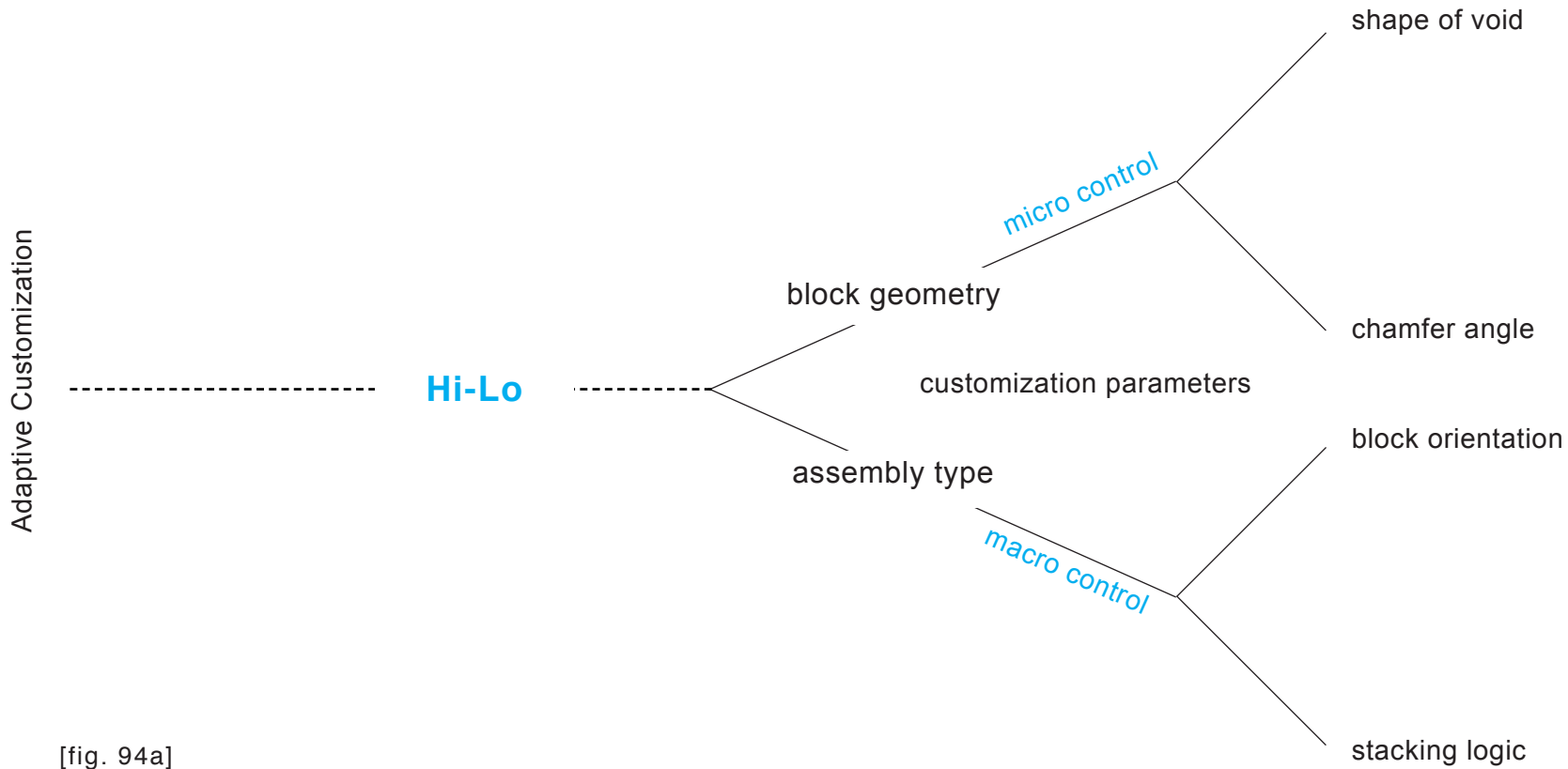

[fig. 94a]

**Hi-Lo** is a system that can be customized based on program and site conditions.

The degree of customization can be controlled at micro and macro levels. At a micro level, the block geometry can be altered by changing the shape and orientation of the void and the chamfer angle of one face. At a macro level, the orientation of the blocks and the manner in which they are assembled in courses can generate unique assemblies. This exploration can be done parametrically via GH, which helps the user visualize and analyze these geometries at the same time. The lo-tech production mechanisms proposed as a part of this study provide the ability to manufacture these customized block geometries without employing computer aided manufacturing technologies.

A thorough study on robust deployment strategies was identified as the next big step to further this research, during the final review. Very interesting thoughts on this topic were discussed during the review. The range of ideas was pretty broad, but can be segregated into four main sections.

**Communication :**

Establishing a communication strategy forms an important part of deploying these manufacturing techniques in the developing world. Communicating information for production to block makers and for construction to masons could be done via -

- a. Drawings and diagrams
- b. Shipping a project specific set of keys to maintain the tilt angle of the mold. Or, shipping a wedge with a specific angle and a specific void insert to produce compressed blocks.

**Accessibility :**

For making these analytical tools accessible on a wider scale, an engine for analysis could be designed to get the information needed for production. In such a scenario, the user or a local master-builder would be able to input parameters such as geographical location and façade orientation to get the desired output. The engine could be made accessible through the world wide web or

could be distributed in the form of a cellphone application.

**Localization :**

A catalog of key combinations (for casting) for different facade orientations could be developed for specific geographic locations, considering climatic conditions and feedback from regional communities. A mechanism similar to a sun-dial could be included in the kit of parts. Instead of generating cut profiles to make keys, the dial could be set at a specific angle to achieve the desired effect.

**Hi v/s Lo :**

How hi-tech does Hi-Lo have to be?

Solar studies could also be performed using the dial mechanism explained above. It would involve a lot of experimentation and observation to understand the behavior of block geometries with respect to solar position. But, such a process will encourage community participation to develop strong local intelligence.

### Future directions

The exploration and experimentation done so far has aided in establishing a system that offers the possibility of digitally generating variable block geometries and their assemblies taking in to account lo-tech methods of production. The process of prototyping scaled blocks has validated the manufacturing concepts/strategies explained in this report. But, these developments have created other channels of thoughts that need to be explored in greater detail.

The following tasks have been identified as possible directions for future research.

1. Perform daylight analysis in greater detail to understand light qualities of different block geometries and their assemblies quantitatively. Test assemblies with different orientations at different locations to understand the change in behavior geographically. Catalog these results to help users understand the behavior of block geometries with respect to solar position, geographical location and orientation.
2. Perform thermal analysis taking material properties in to account and catalog the results.
3. Perform physical tests with different soil-cement combinations to understand material behavior with respect to specific void shapes.
4. Perform tests for compressive strength to understand the structural behavior of the assemblies.
5. Perform tests to understand air flow and visibility for different block geometries and their assemblies.
6. Perform tests to compare the behavior of Hi-Lo assemblies with similar brick 'jali' configurations.
7. Develop and test deployment strategies in a lo-tech production/construction environment.

The above mentioned tests could contribute towards refining the mold design and exploring other lo-tech methods of production.

## References

- Baweja, V., (2008), A Pre-history of Green Architecture: Otto Koenigsberger and Tropical Architecture, from Princely Mysore to Post-colonial London, Doctoral dissertation, University of Michigan
- Benjamin, D.,, “Beyond Efficiency” in Digital Workflows in Architecture, Marble, S., (ed.) (2012), Birkhauser, Basel
- Celento, D., “Innovate or Perish : New technologies and Architecture’s Future” in Fabricating architecture, Corser, R.(ed.) (2010), Princeton Architectural Press
- Crawford, S.,(2010), A Breathing Building Skin, ACADIA 2010
- De Landa, M., Deleuze and the Use of the Genetic Algorithm in Architecture, Neil Leach (ed) (2002), Designing for a Digital World, New York, Wiley
- Duarte J P, (2005), “Towards the mass customization of housing: the grammar of Siza’s houses at Malagueira”, Environment and Planning B: Planning and Design 32(3) 347 – 380
- Elghazi, Y., et al. (2014) Daylighting Driven Design : Optimizing Kaleidocycle Façade for Hot Arid Climate, BauSIM 2014
- Esmaili, Y., (2014), *low-tech-high-touch* : DNA-BRICK ASSEMBLY, MS. Arch thesis, College of Built Environments, UW
- Fasoulaki, E.,(2007), “Genetic Algorithms in Architecture : a Necessity or a Trend ?”, X Generative Art International Conference
- Gupta, V., (1985), Natural Cooling Systems of Jaisalmer, Architecture Science Review
- Griffith, K; Williams, R.; Knight, T.; Sass, L.; Kamath, A. (2012 ), Cradle molding device: An automated CAD/CAM molding system for manufacturing composite materials as customizable assembly units for rural application, Automation in Construction, Vol. 21, 114-120
- Johnson, L., (2011), InterLattice, International PUARL conference
- Kieran, S., Timberlake, J., (2004) Refabricating Architecture, McGraw Hill Co.
- Kasapantoniou, S., (2013/2014), Computational Chair Design using Genetic Algorithms, BENVGACC Computational Synthesis 2013/2014
- Kolarevic, B., Malkawi, A., (eds.)(2005) Performative Architecture, Spon Press, New York
- Kolarevic, B., Klinger, K.(eds.)(2008) Manufacturing Material Effects: Rethinking Design and Making in Architecture, Routledge
- Ledderose, L., (2001) Ten Thousand Things : Module and Mass Production in Chinese Art, Princeton Architectural Press
- Li, L., (2012) The Optimization of architectural shape based on Genetic Algorithm, Frontiers of Architectural Research, Vol. 1, Issue 4
- Madeddu, D., (2011), Interactive facade optimized for daylighting and pedestrian response using a genetic algorithm, XIV Generative Art International Conference
- Malkawi, A., Jabi, W., (1996), Integrating Shadow Casting Methodolgy and Thermal Simulation. In Proceedings of the Solar’96 Conference, 271-276

Marin, P. et al., (2008) A Genetic Algorithm for use in Creative Design Processes, ACADIA 2008

Massie, W., “Remaking in a Postprocessed culture” in Fabricating architecture, Corser, R.(ed.) (2010), Princeton Architectural Press

Menges, A., “Instrumental Geometry” in Fabricating architecture, Corser, R.(ed.) (2010), Princeton Architectural Press

Moe, K., Automation Takes Command : The Nonstandard, Un-automatic History of Standardization and Automation in Architecture in Fabricating architecture, Corser, R.(ed.) (2010), Princeton Architectural Press

Sass, L., Botha, M. Instant House: A model of design production with digital fabrication. International Journal of Architectural Computing, Vol. 4, No. 4, 109–123, 2006.

Sass, L., (2006) Synthesis of design production with integrated digital fabrication, Automation in Construction. Vol. 16, No. 03

Schodek, D.; Bechtold, M.; Griggs, K.; Kao, K.; Steinberg, M.; (2005) Digital Design and Manufacturing : CAD/CAM Applications in Architecture and Design

Willis, D., Woodward, T., Diminishing Difficulty : Mass Customization and the Digital Production of Architecture in Fabricating architecture, Corser, R.(ed.) (2010), Princeton Architectural Press

Woudhuysen, J., Mass Customization and the Manufacture Module in Fabricating architecture, Corser, R.(ed.) (2010), Princeton Architectural Press

## Web references

URL 1 <http://www.flatpakhouse.com/>

URL 2 <http://www.home-cost.com/construction-cost-per-sf.html>

URL 3 <http://www.fabfoundation.org/fab-labs/>

URL 4 <http://www.wikihouse.cc/>

URL 5 <http://www.madeforone.com/us/concepts/MCDefinition.html>

URL 6 <http://www.sketchup.com/>

URL 7 <http://ddf.mit.edu/>

URL 8 <http://modularvariations.files.wordpress.com/2013/02/andrew-kudless-p-wall.pdf>

URL 9 [http://www.earth-auroville.com/auram\\_earth\\_equipment\\_introduction\\_en.php](http://www.earth-auroville.com/auram_earth_equipment_introduction_en.php)

URL 10 <http://www.starship-enterprises.net/files/village-level%20brickmaking.pdf>

URL 11 <http://reflectionsofindia.com/2014/06/16/jali/>

URL 12 <http://www.grasshopper3d.com/>

URL 13 <http://diva4rhino.com/>

URL 14 <http://www.aia.org/aiaucmp/groups/aia/documents/pdf/aiab082771.pdf>

URL 15 [http://www.awninginfo.com/downloads/PAMA\\_LEED\\_final\\_report\\_July2013.pdf](http://www.awninginfo.com/downloads/PAMA_LEED_final_report_July2013.pdf)

URL 16 <http://www.rhino3d.com/>

URL 17 <http://www.grasshopper3d.com/group/galapagos>

URL 18 <http://www.food4rhino.com/project/geco?ufh>

URL 19

<http://www.nzdl.org/gsdImod?e=d-00000-00---off-0hdl--00-0----0-10-0---0---0direct-10---4-----0-1l--11-en-50---20-help---00-0-1-00-0-0-11-1-0utfZz-8-00&a=d&cl=CL3.21&d=HASH4edbf917bee4e6ae86aa2c.23>

URL 20 <https://nayeemasif.files.wordpress.com/2014/04/poetry-in-brick.pdf>

URL 21 <http://biorealis.com/OMV/deeptech/wp-content/uploads/2012/09/CETA-RAM-Block-Press.pdf>

URL 22 <http://diva4rhino.com/>