

Mycelium Infrastructures for Impermanent Futures

Revitalization of an industrial site through the
manufacturing and research of mycelium-
based biocomposite materials

Mariel Dougoud

A thesis
Submitted in partial fulfillment of the
requirements for the degree of

Master of Architecture

University of Washington

2018

Committee Members:

Robert Corser
Kathrina Simonen
Christopher Meek

Program Authorized to Offer Degree:
Architecture

©Copyright 2018
Mariel Dougoud

University of Washington

Abstract

Mycelium Infrastructures for
Impermanent Futures

Revitalization of an industrial site through the manufacturing and
research of mycelium-based biocomposite materials

Mariel Dougoud

Chair of the Supervisory Committee:

Robert Corser
Professor
Department of Architecture

This thesis will use adaptive reuse of an existing industrial agricultural site in an urban setting to activate a new life and a sustainable future to a structure that would otherwise go unused or be demolished. To aid in the reuse of the site this project will demonstrate the use of mycelium-based biocomposite materials made from the root structure of mushrooms; a material that is part of the biological closed-loop cycle and results in minimal waste. This project seeks to envision how the intersection of manufacturing of an impermanent, biodegradable material and research can aid in bringing new aspects of culture and art to a post industrial neighborhood in Chicago, IL. The project will serve as a place to showcase the potential of the materials current and future architectural applications throughout the space in the different functions of the program. As a result, an existing structure becomes a contemporary demonstration of how using natural building materials and technology can aid in creating a sustainable future.

ACKNOWLEDGMENTS

To Rob, Kate, and Chris- Thank you so much for all your advice and encouragement.

To my family and friends - Thank you for all your support.

TABLE OF CONTENTS

THEORETICAL FRAMEWORK

| | |
|---|---|
| The Concept of Waste | 1 |
| Urban Mining..... | 3 |
| Precedents in Theoretical Material Re-use Ecologies | 4 |
| Non-renewable vs. Renewable Resources | 6 |
| Advantages of Impermanence..... | 8 |

INVESTIGATION

| | |
|---|----|
| Theoretical Interpretation | 10 |
| Site Research | 12 |
| Mycelium: A Renewable Material Alternative..... | 16 |
| Mycelium: Current Research | 23 |

METHODOLOGY

| | |
|-------------------------------|----|
| Program Proposal | 26 |
| Adaptive Reuse | 29 |
| Vision and Application..... | 34 |
| Phases of Development..... | 37 |
| Visualizations of Change..... | 40 |

CONCLUSION

49

LIST OF FIGURES.....

51

ENDNOTES.....

54

WORKS CITED

56

This document is best viewed in a single page format.

THEORETICAL FRAMEWORK

The Concept of Waste

“What happens to the building at the end of its useful life? The building should not become waste. Waste is a human invention. In nature the waste of one organism becomes food for another - everything is recycled.”

-Ken Yeang (architect and ecologist, and the principle of Llweleyn Davis Yeang) ¹

In nature there is no waste, it is a regenerative system where all outputs become inputs. Food, shelter, and nutrients for all living things comes from the decomposition of another biological item. Cradle to cradle, a concept created by William McDonough and Michael Braungart, suggests an idea where the elimination of waste can be achieved through incorporating materials into a biological and technical cycle where waste produced are nutrients for other systems and energy is produced with the use of renewable resources.

Materials biodegradable and decompose when microorganisms (bacteria, fungi, and actinomycetes), macroorganisms (insects), and aerobic bacteria break down the plant matter and ingest and bind the particles together. The material that is decomposing provides food for organisms in the form of carbon and nitrogen. Humans have created products that are manufactured from petroleum, the end product of a few million years of natural decay. These chemical components are manufactured to link together and create bonds that are used in many of our materials today. ²



Figure 1: Aerobic bacteria is used to decompose materials

Man-made polymers such as polyethylene (the plastic used in shopping bags) are not recognized as food by these organisms and therefore they do not decompose. They are not recognized because man-made materials use carbon-carbon bonds where many organic molecules are using peptide bonds that link carbon to nitrogen.

The only other way to give these materials another life would be through recycling. When we recycle materials we are breaking it down chemically and converting it into something of typically lesser value. The term 'downcycle' refers to the resulted material that is of reduced quality which, in turn, limits the applications the material can be used in. We need to look to materials that upcycle; where old products gain more value, not less. Materials that are unable to decompose are in a linear metabolism where the product is a one-way commodity that results in waste. To avoid this we need to create products that are part of a circular process that results in nutrients for another life cycle and nothing is wasted.³

The act of production, construction, application, inhabitation, transformation, adaptation, and demolition are stages that waste is produced in a buildings life. According to the EPA building total waste produced from construction and demolition account for 534 million tons, 90% from demolition and 10% from construction, of waste in our landfills today.

As populations and cities grow the demand for materials and resources also grows. This has generated trans-continental material flows that is energy intensive in terms of extraction of natural resources and transportation.⁴

“Between 20 and 25 percent of all carbon emissions are embedded in products that are bound for export,” explained Matthew Lewis, a consultant to ClimateWorks Foundation.⁵

Urban Mining

It is clear that we cannot achieve a sustainable future by continuing to build with the same resources that we currently use. ‘The 21st century will face a radical paradigm shift in how we produce materials for the construction of our habitat. The linear concept of “produce, use, and discard” has proven itself unsustainable in the face of scarce resources and exponentially increasing urban populations. Instead, to achieve a cycle of production, use, and re-use, we must explore alternative materials and approaches to construction.’⁶

“The future city makes no distinction between waste and supply.” - Mitchell Joachim (BFW)⁷

The book *Building From Waste* defines ‘zero waste’ as a goal that is ethical, economical, efficient and visionary to guide people in changing their lifestyles and practices to emulate sustainable natural cycles, where all discarded materials are designed to become resources for others to use.⁸

Urban mining is a process of reclaiming materials and waste products that would otherwise end up in a landfill. There is much potential in building from waste materials and using urban mining to transform, reshape, remodel, and reconfigure waste products into something with a second life. It now becomes a question of what waste is suitable to use and how we can design it to begin to regenerate our cities (See Figure 2). This also raises the question of why the waste state of a material even exists and the possibility that we could design materials from the start to eliminate this result.⁹

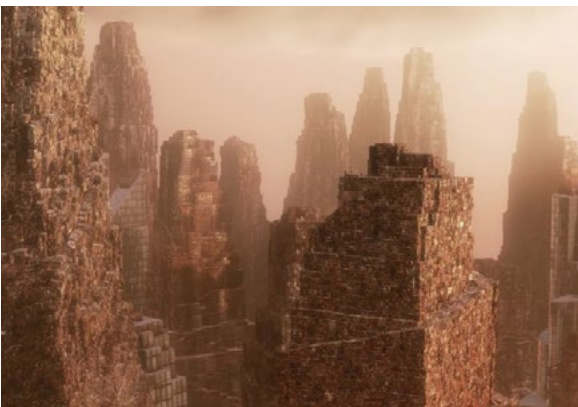

Figure 2: Image from the film Wall-E skyscrapers of waste dominate the horizon in a world too damaged to sustain human life.



Figure 03: Homes, big-box retail, cinemas, supermarkets, business hubs, food production and power plants will depart from their existing sprawled communities and line up along highways to create a truly breathing interconnected metabolic urbanism

Precedents in Theoretical Material Re-use Ecologies

Terreform ONE [Open Network Ecology] is a nonprofit architecture and urban design research and consulting group located in Brooklyn, NY that promotes smart design in cities. One project where they envision the future of waste as a building material is called Rapid Re(f) use: 3D Fabricated Positive Waste Ecologies - URBANEERING BROOKLYN 2110 City of the Future (See Figure 3). This project strives to capture, reduce, and redesign the 36,200 US tons of waste that NYC disposes of per a day (See Figure 4). The way that this could be done is through automated 3-D printers that rapidly process trash and trash compaction devices that would craft shapes into smart ‘puzzle blocks’ for assembly. ‘The blocks of waste material could be predetermined, using computational geometries, in order to fit domes, archways, lattices, windows, or whatever patterns would be needed.’

The main objective was to establish a smart, self-sufficient, perpetual-motion urbanism. The strategy includes the replacement of dilapidated structures with vertical agriculture and housing merged with infrastructure. In this project waste is not recycled through infrastructural mechanisms but instead upcycled in perpetuity. ¹⁰

“For hundreds of years we designed cities to generate waste. Now its time that we begin to design waste to regenerate our cities.” ¹¹

With this idea in mind it is possible to re-think the way we build with materials today and how we can plan for a future that is focused on using materials that are part of a closed-loop life-cycle.

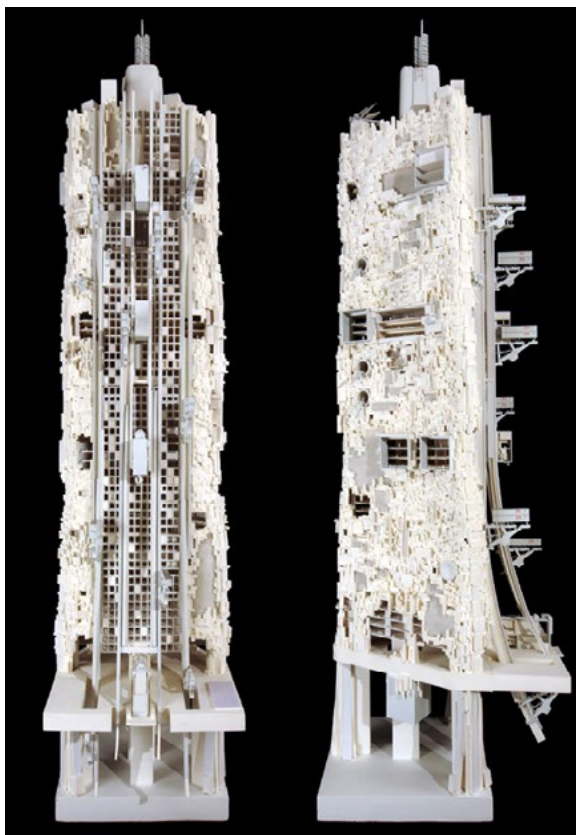

Figure 4: A tower made from one day of 36,200 tons of waste that could be constructed in 24 hours.

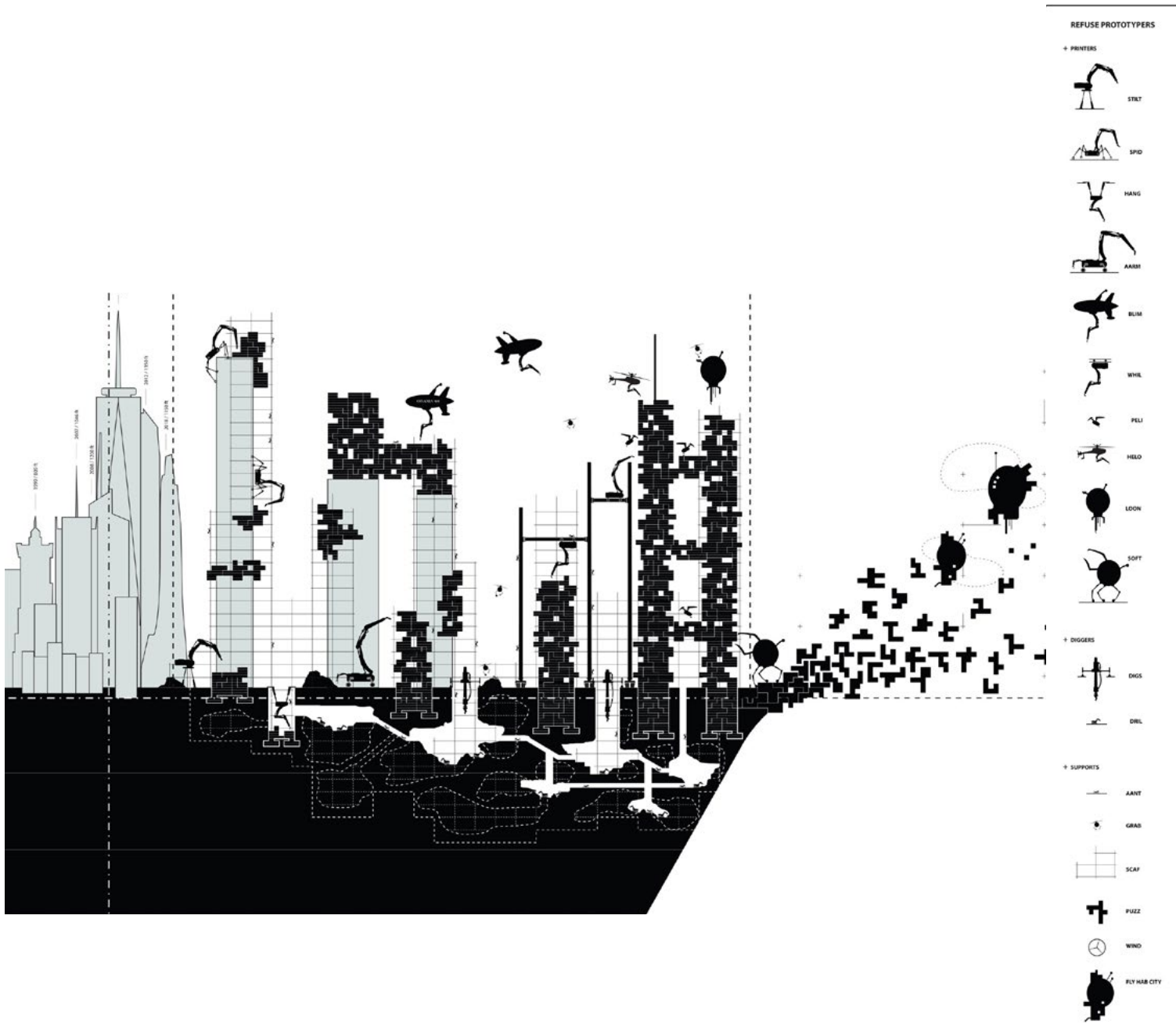

Figure 5: A timeline of New York City showing the historic city on the left and future of reuse city on the right. It shows a positive waste society that envisions the use of new technology

"Automated robot 3d printers are modified to process trash and complete this task within decades. These robots are based on existing techniques commonly found in industrial waste compaction devices. Instead of machines that crush objects into cubes, these devices have jaws that make simple shape grammars for assembly. Different materials serve specified purposes; plastic for fenestration, organic compounds for temporary scaffolds, metals for primary structures, and etc." <http://www.terreform.org>

Non-renewable vs. Renewable Resources

“Plants consume carbon dioxide and produce oxygen as a waste. Animals consume oxygen and produce carbon dioxide as a waste.”¹²

Any significant losses to this cycle would disrupt a closed-loop system. This natural cyclical process where plants grow, live, and biodegradable can be applied to building materials. All earth's resources are defined as renewable or non-renewable. Non-renewable resources are those that cannot be renewed through harvesting or renew themselves slowly (iron ore, crude oil, and more recently sand and aggregates are also becoming rare). The extraction of resources and the fresh water used in the processing are also contributors to the overall pollution emitted.¹³ Typically non-renewable materials are part of an industrial cycle where after a buildings life the waste is either recycled or goes to a landfill. Designing closed-loop material systems are currently not part of our mainstream practice.

One way that we can reduce our use of raw materials in the production process is to use waste products and look to unused resources. Timber, a biodegradable material, only makes up 3.1% of total building materials used. Biodegradable building materials have a long history of use but in recent times have been replaced by more structural and longer lasting materials such as concrete and steel.

Ecological materials are materials that enhance the environment during their lifecycle rather than negatively impact the environment.¹⁴ These materials minimally impact the environment during the material manufacturing process, have minimal hazardous waste, and have the ability to upcycle.

The life cycle of a material can be analyzed by looking at the materials embodied energy. Embodied energy can be derived from many stages in a materials life: the energy used to extract raw resources, process materials, assemble product components, transport between each step, construction, maintenance and repair, deconstruction and disposal.

When looking at the differences between embodied energy of industrial materials versus more ecological materials we can see that the manufacturing, transportation, and construction of industrial materials is much higher in terms of overall energy used and resulted greenhouse gas emissions.

The lifespan of a material can be governed by 4 factors; (1) the materials physical structure and chemical composition, (2) how it is constructed and executed into a building, (3) the climatic and chemical conditions it is under, (4) the maintenance and management.

“If there are any materials of a lesser quality, then it is important that they are easily replaceable while the more durable materials can be dismantled for re-use or recycling in the case of demolition.”¹⁵

Buildings should be built for high durability because there is twice as much damage to the environment for a product that lasts 30 years in comparison to one that lasts 60 years. The reason that there is twice as much damage caused is because modern buildings typically have all the different layers of a building incorporated into a single structure. It is therefore normal to tear down buildings that have integrated construction assemblies that are difficult to maintain.

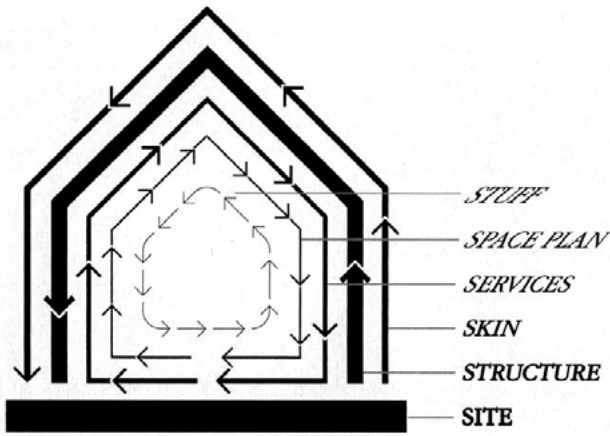

Figure 6: Diagram showing the main layers of a building.

Figure 6 is a diagram called 'Shearing Layers of Change' showing the main layers of a building and the different systems of each layer and the rate of change of each component. It is showing that the outer layer of the main structure is what should last the longest while the interior space plan, services, etc. are renewed at considerably shorter intervals. It is therefore clear that in order to create the most efficient and long-lasting buildings that we need to create independent systems that allows them to be regenerated, re-used, and disassemblable.¹⁶ In addition to energy use during material manufacturing, building use, and demolition there is significant energy input for transportation of materials.

Advantages of Impermanence

Antonio Sant'Elia wrote in 1914:

"...The fundamental characteristics of Futurist architecture will be its impermanence and transience. Things will endure less than us [sic]. Every generation must build its own city. This constant renewal of the architectonic environment will contribute to the victory of Futurism...."¹⁷



Figure 7: The architectural style of the Jingu Shrine

When applying Antonio Sant'Elia's idea to materials it is true that less durable materials that renew themselves due to their biology can positively contribute to the renewal of future built environments. There are advantages to building structures that are more 'impermanent' in terms of use and materiality instead of 'permanent' and made to last for many generations.

An example purposefully built impermanent structures is the Shikinen Sengu ceremony that takes place at the Jingu Shrine in Ise City, Japan. The event happens every 20 years and involves the deconstruction a shrine and rebuilding it at the adjacent alternative location for the purpose of passing down skills of craftsmen and buildings onto future generations and preserving the original construction method from 690 AD (See Figure 7). This methodology of building with impermanence allows the structure to be eternally existing although it is constructed entirely out of wood, hinko -Japanese cypress, a biodegradable material. It also signifies that mentality that old is welcomed as new. This technique became customary firstly because of the style of the building which is based off of Japanese grain warehouses. The construction technique of wood construction and a thatched roof functioned very well as a storage for grain but it did eventually start to rot and would have to be rebuilt.

The materials that are deconstructed from the shrine are used in various second applications. The 11-meter tall pillars are used for the torii gate and Uji Bridge that lead into the Jingu Shrine. The other pieces of the deconstructed shrine are sent to other shrines around the country as material to use for renovation tasks.

The custom of rebuilding the sanctuaries every 20 has create a reverence for life in the Japanese spirit, a passing down of skills from generation to generation, and allows the shrine to have an infinite future. It requires the participation of many citizens and is a prideful, lively and ceremonial event. Everyone in the town participates in the brings people together and creates regional bonds and resilience.¹⁸



Figure 8: The citizens participating in the ceremonial event of the shrine rebuilding

INVESTIGATION

Theoretical Interpretation

When striving for the goal of minimizing and elimination of waste in a buildings life we must consider the material lifespan of each construction material. One interpretation of the 'Shearing Layers of Change' building diagram is that it should also take into consideration material durability and ability to resist decay. The diagram argues that different layers of the building are renewed and replaced at considerable different intervals. My proposal is that these layers should use materials that naturally have a similar lifespan. In Figure 9 you can see that I am starting to re-interpret the diagram to apply materials with a longer lifespan to the longer lasting elements of the building, site and section. I am also applying less durable materials, wood and bio-materials, to the interior, more quickly replaced elements of a building.

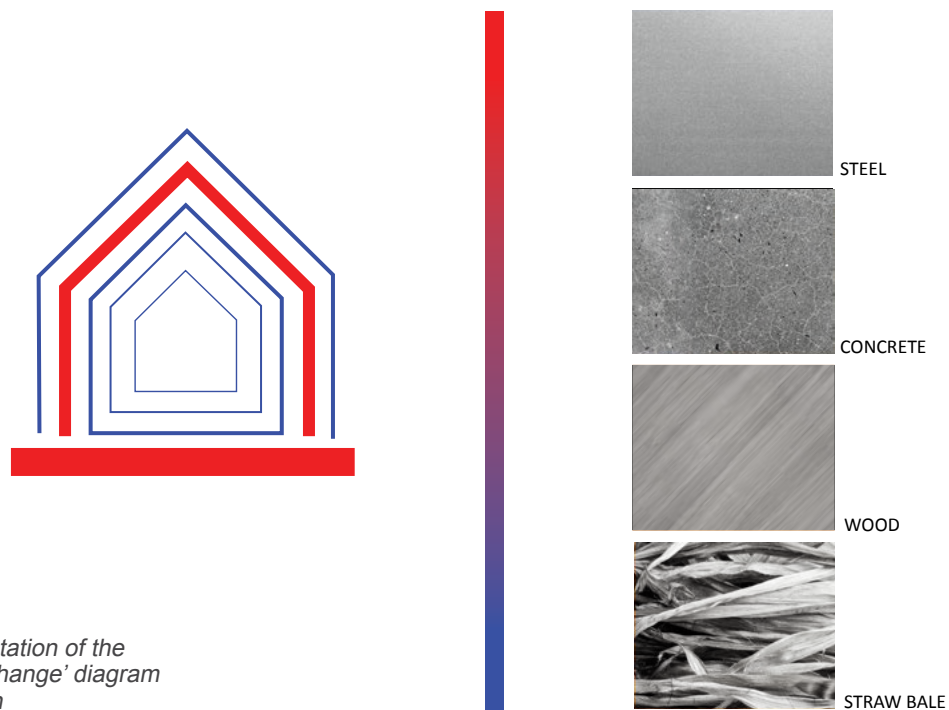

Figure 9: Re-interpretation of the 'Shearing Layers of Change' diagram using material lifespan

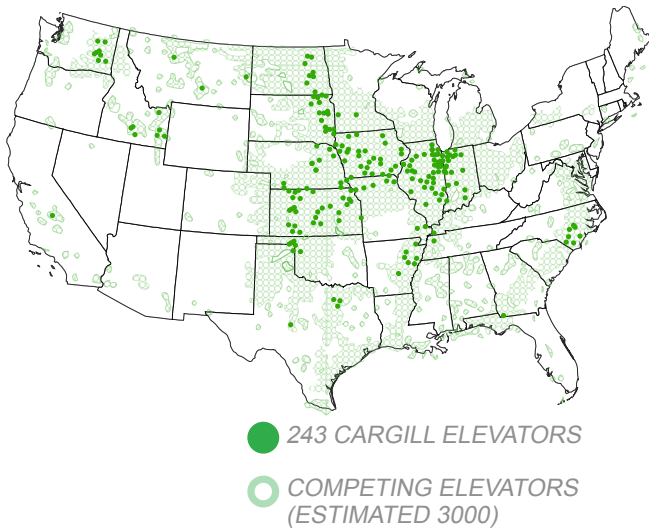

Figure 10: Grain Elevator locations across the USA

My thesis proposal is to investigate ways that this methodology of material and program cycles could be applied to future building projects. In order to minimize building waste I am proposing a method of using natural, biodegradable materials and in situations where that is not possible for structural reasons using reused and recycled materials. In this project there would be a need for a site and structure that are durable and made of materials with a long lifespan in order to be structurally stable, this led me to an investigation of adaptive reuse potentials and typologies.

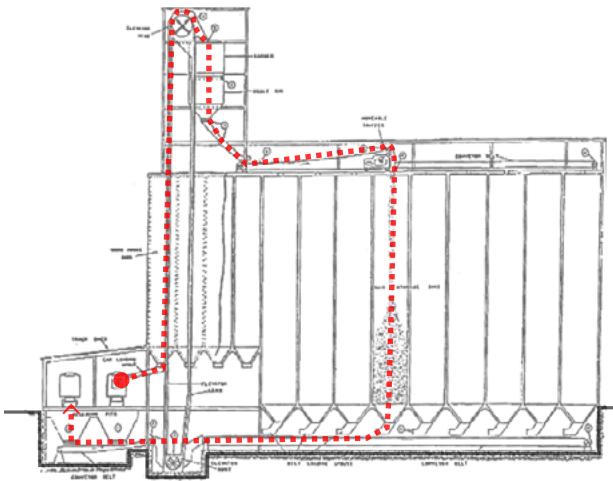

Figure 11: Grain elevator and silo section. Red line showing circulation of grain from loading and unloading

One typology of buildings that are made of structurally sound materials and many are in an unused state are grain elevators and silo buildings. During the 1900's grain elevators were a new mechanical equipment invention that due to the expansion of the railroad, became rapidly constructed. Since then, due to improved transportation, there are grain elevators that serve multiple farms leaving an abundance of unused and obsolete grain elevators across the United States (See Figure 10). The charts show that the grain elevator locations coincide directly with the corn production areas and rail roads.

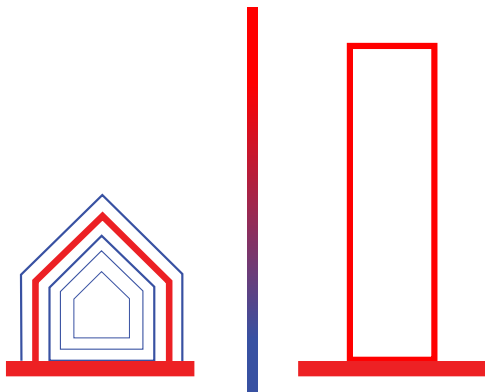

Figure 12: Comparing the 'Shearing Layers of Change' diagram on the left to what a silo building would look like. A silo is comparable to what the 'site' and 'structure' is in terms of material durability and lifespan.

Another reason why this building typology has become obsolete is because of their specialized use and architecture that results (Figure 11). They are a piece of mechanical equipment that consists of a steam powered conveyor that takes grain up from a rail car or ship and files it into a silo. The specific type of grain elevators and silos constructed during this time period were typically reinforced concrete tubes clustered together.

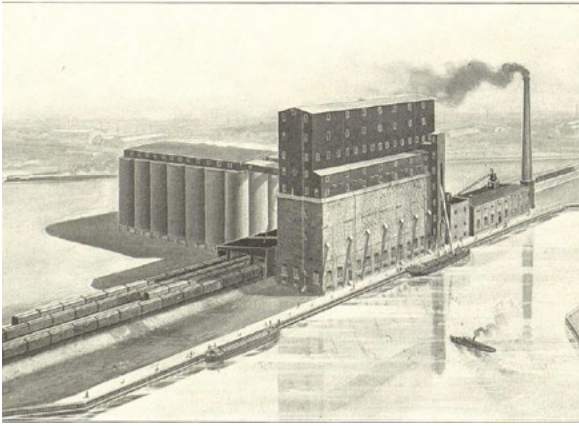

Figure 13: Historic site axon from the 1932 development plan



Figure 14: Historic site plan of the Damen Silos

Site Research

One area of the USA with the most abundance of grain elevators was Chicago, IL. This is due to the access for trade that the city had to railroad, water ways, and the Great Lakes. The site I have chosen to do my project on is the Damen Silos located in the South-West industrial corridor of Chicago, IL. This site is in an area of the industrial corridor that is planned for redevelopment. The site was established in 1906 as a agricultural storage and trade hub (Figure 13). In 1932 parts of it were rebuilt using reinforced concrete. In 1977 it became no longer in use and for the last 41 years it has been an abandoned site.¹⁹

The site is located less than 4 miles from the downtown Chicago loop and less than 2,000 feet from a residential neighborhood (Figure 15). The neighborhoods that surround it are Pilsen in the north and McKinley in the south. These neighborhoods are multicultural and artist neighborhoods that are a host for many art galleries and cultural events. In addition, a series of site analysis diagrams (Figure 17) show that the site is in an area of a planned manufacturing district and it also has three other unused, dilapidated buildings on the site.

The photos seen in Figure 18 shows how the site it currently being occupied. Although it is no longer being used for it's original purpose it still has become a place for new activities due to the neighborhoods that surround it. Local street artists and civilians have utilized the site in various ways; wall mural painting, a place to practice flow arts, and urban exploration.

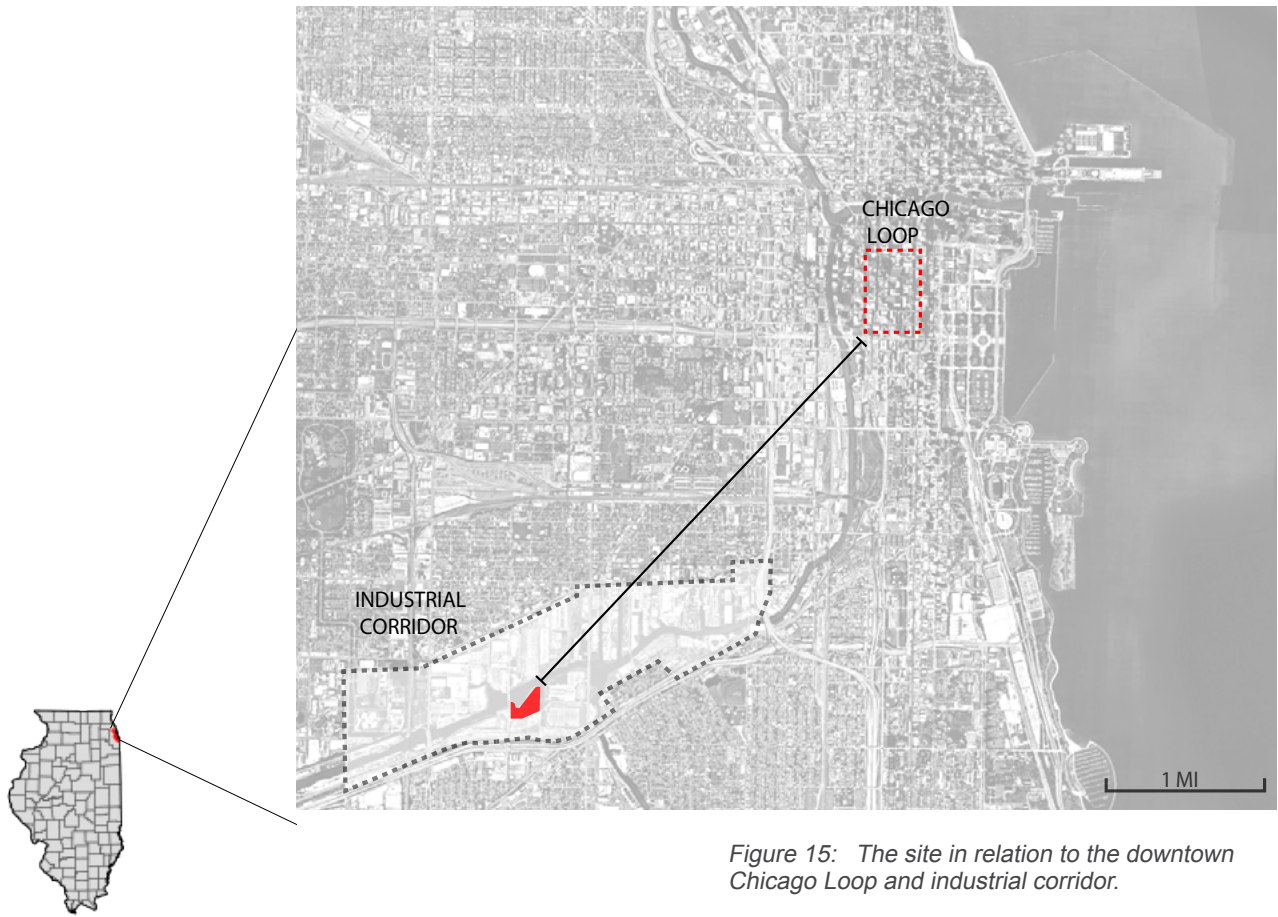

Figure 15: The site in relation to the downtown Chicago Loop and industrial corridor.

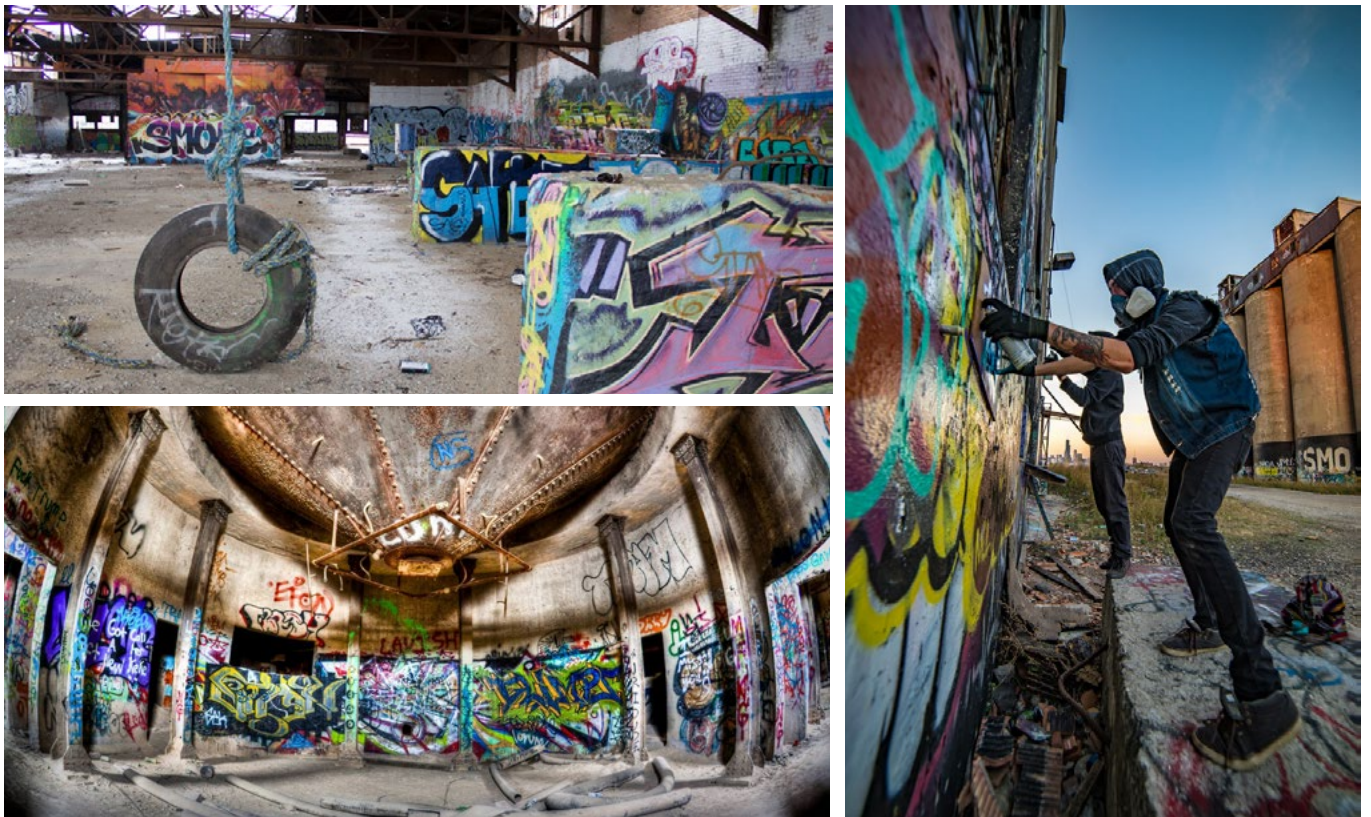

Figure 16: The site today



PLANNED MANUFACTURING DISTRICT (PMD)
RESIDENTIAL PROHIBITED



IN-US
UNUS



RESIDENTIAL



CHICAGO RIVER
HIGHWAY 55
ROAD
RAILWAY

Figure 17: The site analysis maps. Top-left: the site itself. Top-right: The site is in a Planned Manufacturing District. Lower-left: The industrial corridor has both used and unused buildings and three of the unused buildings lie within the site parameters. Lower-right: The site is less than 2,000 ft away from residential neighborhoods. Bottom-left: The site is in close proximity to the Chicago River, highways, and roads.

In order to demonstrate how we can use not only materials and buildings that already exist and but also more natural materials I am looking to the site for resources. The site is has resources in the form of other unused existing buildings, soil, and plants (Figure 18). By cultivating and harvesting natural, biodegradable materials it is possible to construct buildings to allow for change and have those changes not add to building waste but rather contribute to an already natural cycle of a materials life. In order to grow and cultivate a building material I began a more intensive search for biodegradable, compostable materials that could come from cultivation of the site.



Figure 18: Axon view of the site from Google Earth

Mycelium: A Renewable Material Alternative

Building construction and materials have a substantial role in contributing to building waste and energy consumption. In the USA 40% of the landfill relate to construction and demolition.²⁰ To minimize the amount of carbon consumed by buildings we should use materials that have zero-embodied energy. The development of bio-composite renewable materials can dramatically increase the sustainability of a building. The production and manufacturing of bio-composite materials is a growing industry. Bio-composite materials have been used since 3000 BC by the Sumerians who used a mixture of clay and straw. In recent years researchers have found composite materials that are structural and profitable.²¹

A material that achieves structural performance with minimal environmental impacts is mycelium-based bio-composites. Mycelium is a scientific term for the web-like root structure of mushrooms. These roots act as a binding agent when in contact with woody biomass or seed husks. Nutrients are absorbed into the mycelium and by facilitated diffusion and active transport. According to Ecovative, a company responsible for much of the current research on mycelium, the mycelium uses the energy from the wood biomass and builds a chitinous polymer self-assembling matrix. As a result a solid block is created from whatever mold the form is grown in.²² The material is then dehydrated to stop the expansion of the mycelium fungus. In 2007 Ecovative started to commercialize mycelium based projects by creating products such as alternative styrofoam packaging, lamps, blocks, acoustic panels, wall insulation, etc.

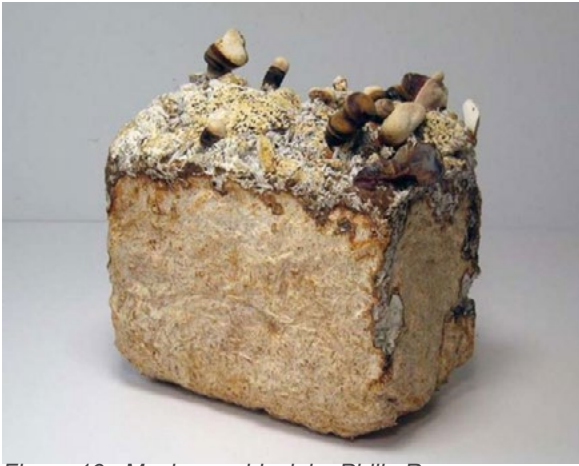

Figure 19: Mushroom block by Philip Ross



Figure 20: "Mycotecture" art installation by Philip Ross

They have a 10,000 sq ft myco-factory in Green Island, NY.

When looking to a new material type for interior and architectural use there are many considerations to take into account. There has been various testing and research done on mycelium composites to test its structural capabilities, thermal properties, water and fire resistance, and interior health impacts. With scientific data it has been proven that this material is not only feasible but also rational and beneficial from the economic and environmental perspective.²³ In addition to the Ecovative company making products there are quite a few built projects that demonstrate and test the capabilities of this material. Based on the ideas of mycologist Paul Stamets, artist Philip Ross created a patent to produce fungus structures in 2012 (Figure 19 and Figure 20). His installation "Mycotecture" used mushroom bricks made from Reishi mushroom cultures. The bricks are "nontoxic, fireproof and mold- and water resistant, and it traps more heat than fiberglass insulation".²⁴

According to the EPA styrofoam and other foam products account for 25% of waste in landfills.²⁵ In 2013 Ecovative designed a tiny house to demonstrate the use of mushroom Insulation as an alternative for foam insulation. In this project the mycelium and corn stalk mixture was inserted into a wall cavity between two pieces of wood and the natural bonding elements of the mycelium bonded to the wood forming an airtight seal. The wall naturally dries out over a month and the result is an extremely strong, insulating, and fire resistant wall system. This project also won second place for the Cradle to Cradle Product Innovation Challenge.



Figure 21: Ecovative's Mushroom Tiny House to demonstrate the use of their mycelium insulation material

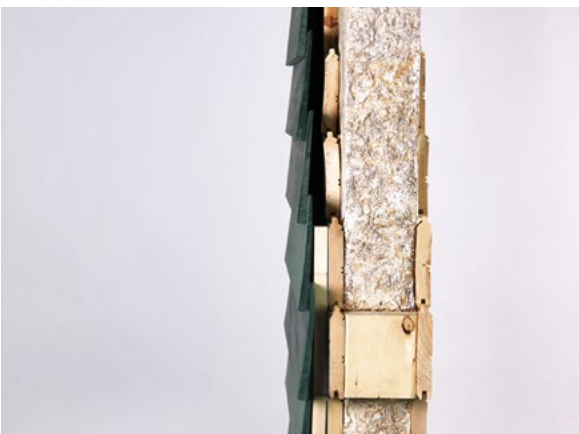

Figure 22: Mycelium insulation material

When comparing this product to the more typical insulation, polystyrene (XPS), the advantage is of using natural material but the R-value is lower. Polystyrene has an R-value of 5 per inch where mycelium insulation has an average of 3 per inch.²⁶

The insulation has been demonstrated in a mushroom tiny house they built in 2013 (Figure 21 and Figure 22) Indoor air quality is another important consideration for the material. One advantage of the material is that it is a natural adhesive and doesn't have any volatile organic compounds (VOCs). Mycelium doesn't use spores to grow and once it is dried it stops growing so there is no indoor air quality issues. insulation is still on a order only market product bit plans for the product to enter the market costing about \$0.66 per board foot. There are no allergy concerns because the mushrooms used are similar to a commonly used medicinal mushrooms (found in nutritional supplements). "The fungi are rendered inert, unable to continue to grow or produce allergenic spores, by a key step in Ecovative Design's production process. The production and stabilization of Greensulate® and Ecocradle® prevents the fungi from producing spores."²⁷ The material is able to be water proofed but naturally it is not waterproof. Ecovative states, "It is water resistant to a certain point, but long term exposure to moisture will cause the material to begin its decomposition process. Mycelium is naturally hydrophobic, but the substrates we use can absorb water. If the material is given a chance to dry out, then it likely won't affect the material's structure. We recommend coating it to make it waterproof."²⁸

"The Living" is an Autodesk funded lab that created blocks for an art installation at the MoMA in NYC titled "Hy-Fi Project".²⁹

Based on the technique developed by Ecovative they created 10,000 bricks by combining mycellium with corn stalks and grew them in molds in 5 days (Figure 24). The design of the prototype was made to draw breezes through the structure and cool the shaded interior. The top layer of bricks is made of the steel molds they used to make the mycelium bricks with. This is to reflect more light into the interior. David Benjamin, architect and founder of the Autodesk studio called 'The Living' states: "Our organic bricks are exciting because they harness the incredible 'biological algorithm' of mushroom roots and tune it to manufacture a new building material that grows in five days, with no waste, no input of energy, and no carbon emissions."³⁰ In addition the mortar used to secure the bricks is also compostable. Both the bricks and mortar were composted into local community gardens at the end of the project. (Figure 23)



Figure 23: Hy-Fi Project photo



Figure 24: Hy-Fi Project brick molds

ARUP and Columbia University Laboratory did a series of structural tests on the material to define its capabilities they found it to be structurally sound at 40 mph and able to withstand 65 mph winds. When comparing this material to concrete it does not have nearly the same compressive strength, concrete is 4000 psi(28 MPa) - 10,000 psi(70 MPa) and the mushroom bricks can only withstand 30 psi (0.2 MPa). Although it cannot support as much weight the mushroom bricks are much lighter than concrete. Mushroom bricks weigh 43kg/m³ and concrete weighs 2,400 kg/m³

³¹

The most recent demonstration of the material a collaborative between Professorship of Sustainable Construction at Karlsruhe Institute of Technology (KIT)



Figure 25: Render by 'The Living'

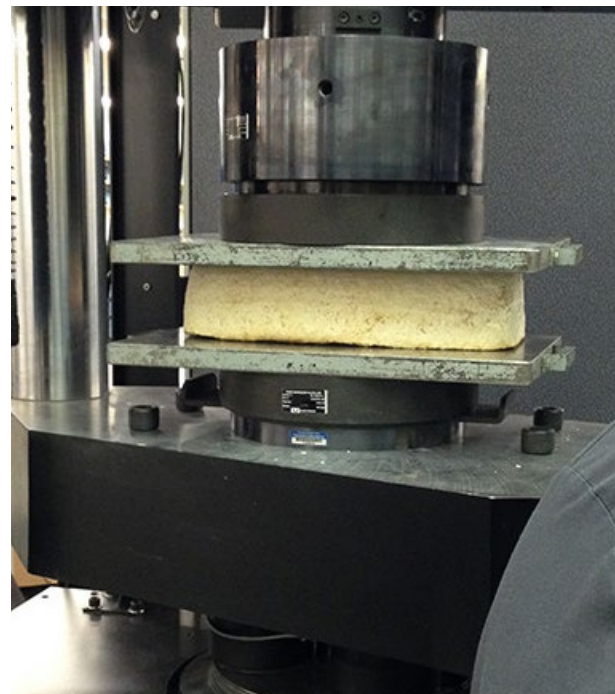

Figure 26:
Far Left: Fire
resistance testing at
Ecovative

Left: Testing the
compressive
strength at
Columbia University
Laboratory

and the Block Research Group at the Swiss Federal Institute of Technology (ETH) Zürich. Their project 'MycoTree' was designed for the Seoul Biennale for Architecture and Urbanism 2017(Sept-November) and is the centerpiece of the "Beyond Minding - Urban Growth" exhibit.³² The bulk of the structure is the mycelium components the connectors are made from bamboo. The project works to explore the load-bearing mycelium components using 3D graphics statics, keeping the weak material in compression. "Using polyhedral form and force diagrams, it allows exploring and discovering efficient but expressive structural forms, going beyond the arch or vault in compression, such as the compression-only branching geometry of MycoTree".³³ It is an exploration of how this material can achieve stability through a 3D generated geometry." (Seen in Figure 27)When building with materials that are weak in tension and bending, good geometry is essential for maintaining equilibrium through contact only - that is, through compression. Funicular geometry has the advantage that stresses in it are very low. Achieving stability through geometry rather than through material strength opens up the possibility of using weak materials". The structure could therefore be materialized using developable surfaces which can be cut from sheet material.³⁴ The components themselves were fabricated in a similar way to the Hy-Fi Project in NYC. They components are made with mycelium and a sterilized substrate and over the course of a few days. The mixture takes the form of a mold, densifies, and dries out. MycoTech is a young mushroom company in Indonesia that was the production partner on the project.

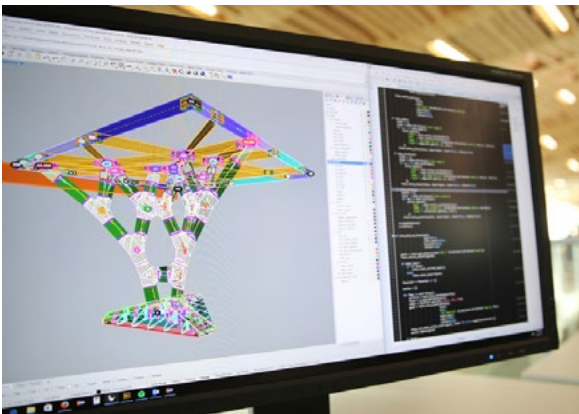

Figure 27: MycoTree polyhedral structural form diagram



Figure 28: MycoTree at the Seoul Biennale for Architecture and Urbanism 2017



Figure 29: MycoTree component fabrication



Figure 30: structural beam



Figure 31: structural panel



Figure 32: Textile material

Mycelium: Current Research

In an interview with Ecovative's research department, Grow.Bio (Shane Boland and Grant Goldner), I became more aware and knowledgeable about the current research happening with mycelium materials. Ecovative is working on using a variety of substrate materials (hemp, kenaf, flax, and aspen) to bind with mycelium. They are also using a new manufacturing process to create more structural materials that are part of their mCore Structural Panels. Figure 30 and Figure 31 show their 'beam' and 'panel' products both of which has 50 psi compressive strength and are used as material for furniture, doors, building assemblies, and structural panels.

Ecovative also has a team that is developing textile products such as the one shown in Figure 32. This product is an alternative for leather. Ecovative has also done research about the nutrients that are a result of the Myco Foam compost. Figure 35 shows how they compared the nutrients to maple leaf compost and tested the produce that resulted from it.³⁵

In addition to Ecovative making progress with material research there are also various researchers and artists around the world that are exploring this subject. Another organization that is using textiles for fashion exploration is NEFFA in Amsterdam, Netherlands.³⁶ Figure 33 and Figure 34 show their fungi textile experiments and dress material which they named MycoTEX. MycoTEX will be on display as part of the Fungal Futures Exhibit opening Summer 2018 in Utrecht. This exhibit showcases new materials and processes coming from the fungal micro-organisms.³⁷



Figure 33: Mycelium-based textile dress by NEFFA

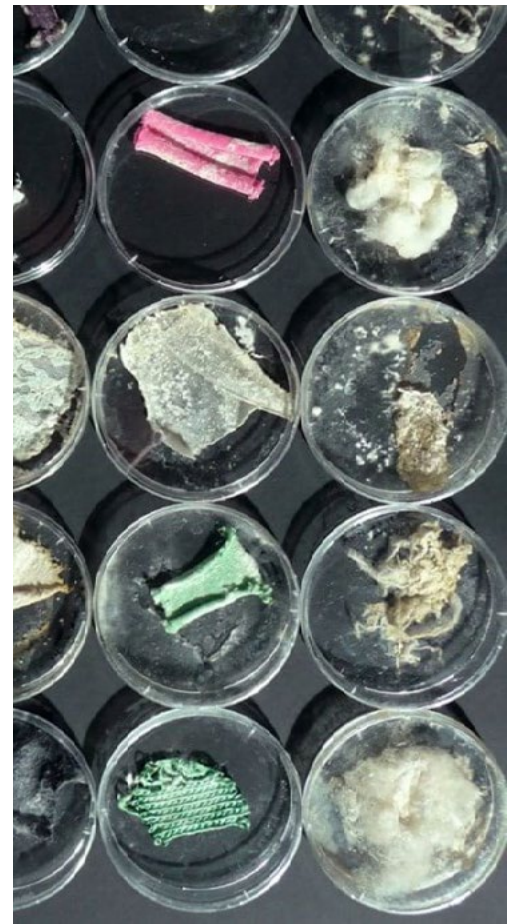

Figure 34: Textile material testing



Figure 35: Ecovative compost research

Dutch designer Eric Klarenbeek used mycelium to 3D-print a chair for the Dutch Design Week 2013 (seen in Figure 36). Eric Klarenbeek writes:

“This chair is really a metaphor for what could be made with this technique of 3D printing a living organism and then have it grow further. It could be a table, a whole interior or even a house. We could build a house with it.”³⁸

He also printed with straw substrate as seen in Figure 37. In conclusion, mycelium-based biocomposite materials have much potential in terms of using new technology and fabrication techniques to advance future architectural applications. The research done on the material will lead to future products that are more structurally sound and technology driven.



Figure 37: 3-D printed segment of straw core.



Figure 36: 3-D printed mycelium chair

METHODOLOGY

Program Proposal

Mycelium-based composite materials have much potential in terms of architectural applications which we have seen through the current research and testing of the material. The material is in a constant evolution of transforming and developing into a more stable, durable, waterproof architectural material. My project proposal is to use this material and its naturally closed loop cycle to integrate it into the site by growing and discarding the waste in the form of compost. I am looking to create a place where the material can be manufactured, researched, and the potential applications tested in and around the building. In order to create a place to manufacture the material I looked to Ecovative's current model for factory manufacturing.

The Ecovative factory is 32,000 sf and is the recreation of the material forming in nature at an industrial level manufacturing (see Figure 38). That process can be broken down into three distinctive steps in the manufacturing process: mixing the agricultural substrate with the mycelium and water, forming the material into a pre-formed mold and then storing that material mixture in the mold for several days while the material naturally forms and binds together, and the last step would be drying the material out in an oven and doing any type of post-processing on the material. Figure 39 shows images of what these three distinctive steps look like in the current factory. One thing that this current factory does not do is grow and compost the material on the site. This is a step that would facilitate access to the agriculture being grown and eliminate the need for transportation costs for the agricultural substrate.



Figure 38: Ecovative factory located in Green Island, NY

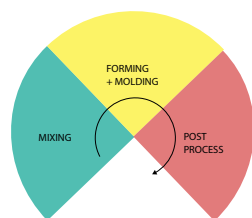

Figure 39: Ecovative factory processes and equipment

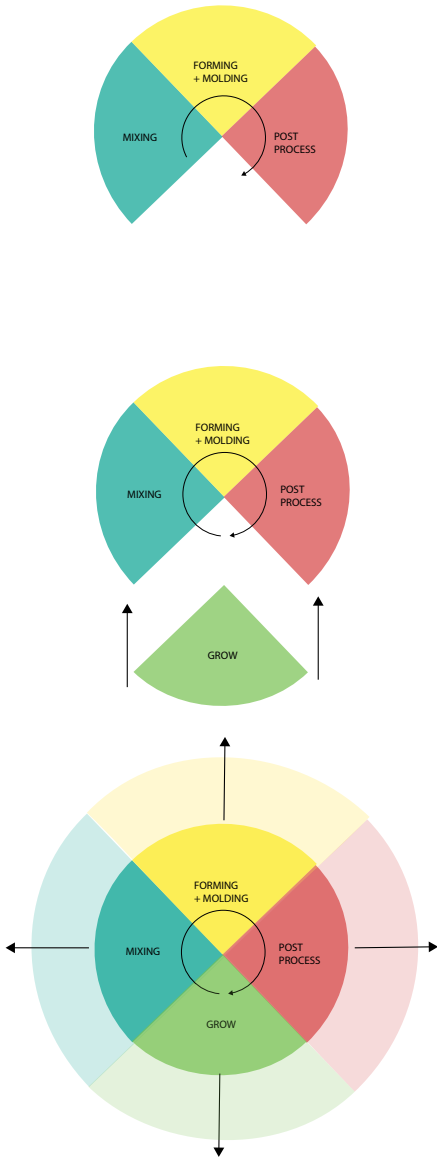

Figure 40: Program proposal diagrams

As demonstrated in Figure 40 diagrams I am closing the loop of the factory processes by adding growing and composting of the material. The third diagram is showing that I am in addition planning to add space for expansion of the facility. Expansion of the facility is necessary due to the increasing amount of mycelium based research going on within in the past few years. I wanted to create spaces that would allow the facility to grow and expand with future research and testing facilities. Some research spaces I am initially planning for are for testing of the mycelium and agricultural substrate mixture and allowing expansions for biochemical engineers to test the structural capabilities of the resulted material. Other research offices would cater to 3-D printing of the material, textile research, insulation, acoustic panel, and testing of beams and columns made of the material.

This new facility would also include spaces for public involvement in the growing, making, and testing of the material. The diagram below (Figure 41) shows how the manufacturing, research, and testing would be intersected with public involvement in the form of makerspaces, agricultural growing, and event spaces where the material tests would be showcased.

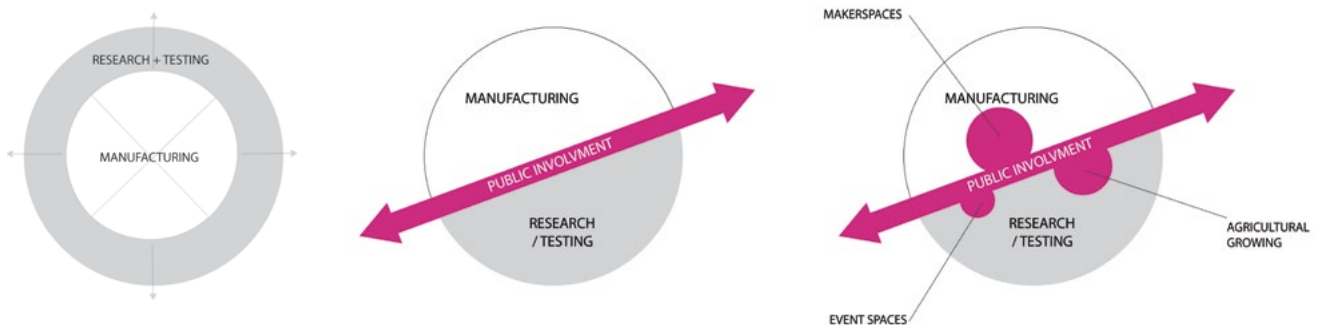

Figure 41: Program proposal diagrams incorporating public involvement



Figure 42: Heatherwick Studio - Zeitz MOCAA art galleries- Cape Town, reuse of a 1920 grain silo



Figure 43: Heatherwick Studio - Zeitz MOCAA art galleries- interior atrium



Figure 44: Heatherwick Studio - Zeitz MOCAA art galleries- interior atrium cut out

Adaptive Reuse

In order to do an adaptive reuse project of concrete silos and a grain elevator there would need to be some strategic manipulation of the structures in order to allow for occupancy standards of daylight and air. For my specific site I first was able to do sunlight analysis on the site using Ladybug for Grasshopper. From this I was able to find where the sunlight hours were most frequent and the total radiance. Figure 46 shows the daylight hour range for the hottest week of the year. From there I then decided to remove the roof of the existing building and cut away faces of the building to allow for daylight access (Figure 47). In this strategic cutting of the silos I would be creating new, more open spaces that would be inhabited in the future.

The physical cutting and moving of silos is possible and has been demonstrated in multiple scenarios. One project by Heatherwick studio, was able to cut the silos and create an art gallery. (Seen in Figure 42, 43, and 44). In another scenario silos were able to be physically moved with equipment in Figure 45.



Figure 45: Moving of a silo at Kreider Farms in Manheim, PA to create an observation tower

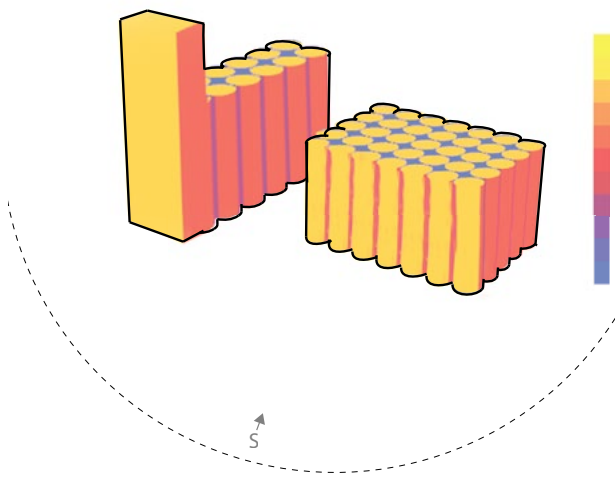

Figure 46 : Sunlight analysis of summer solstice (made using Ladybug for Grasshopper)

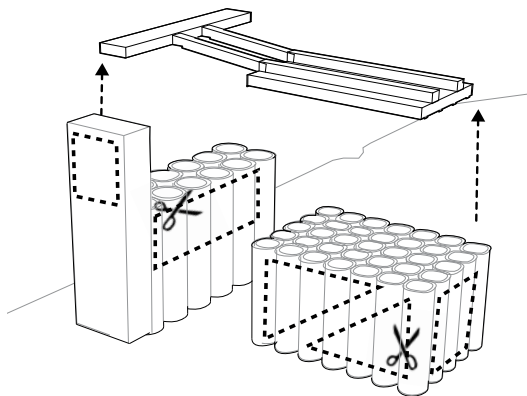

Figure 47: Diagram showing cutting and removing parts of the silos

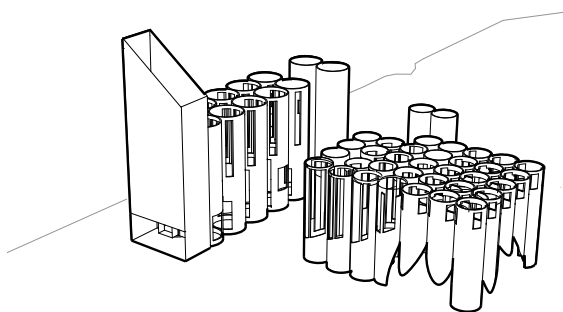

Figure 48: Diagram showing resulted skeletal structure

The site of the Damen Silos is in an industrial corridor where many pollutions and toxins still reside today. Therefore the reuse of this site would be a step-by-step process including remediation of the site and then incremental growing. There would also be potential to reuse the depleted existing buildings on the site. One way this would be done is through the cutting and manipulation of the existing silos there would be leftover concrete waste that could then be recycled on the site through process of crushing and refining the concrete (Figure 49). This recycled concrete product could then be used on the site as paving of roads and sidewalks.

The remediation of the site would be possible through a process of mycoremediation. Mycoremediation is the use of mushrooms to extract pollutants and toxins from soil (Figure 50). Once the soil is remediated you can then grow agricultural products to be used in the composite materials. The types of agricultural substrate that Ecovative is currently using is hemp, flax, aspen, and kenaf. These could all be grown on the site, used for creation of the material, and composted and become part of the soil again (Figure 51 and Figure 52).

All of these site cycles would happen simultaneously and help to grow and transform the site. The diagram shown on Figure 53 shows how the growth of the site, program, and mycelium research would happen in a non-linear form over time. On the X-axis of the chart we have time in years that the site would be developed and on the Y-axis there is square footage of the site.



Figure 49: Concrete Recycling



Figure 50: Mycoremediation



Figure 51: Planting

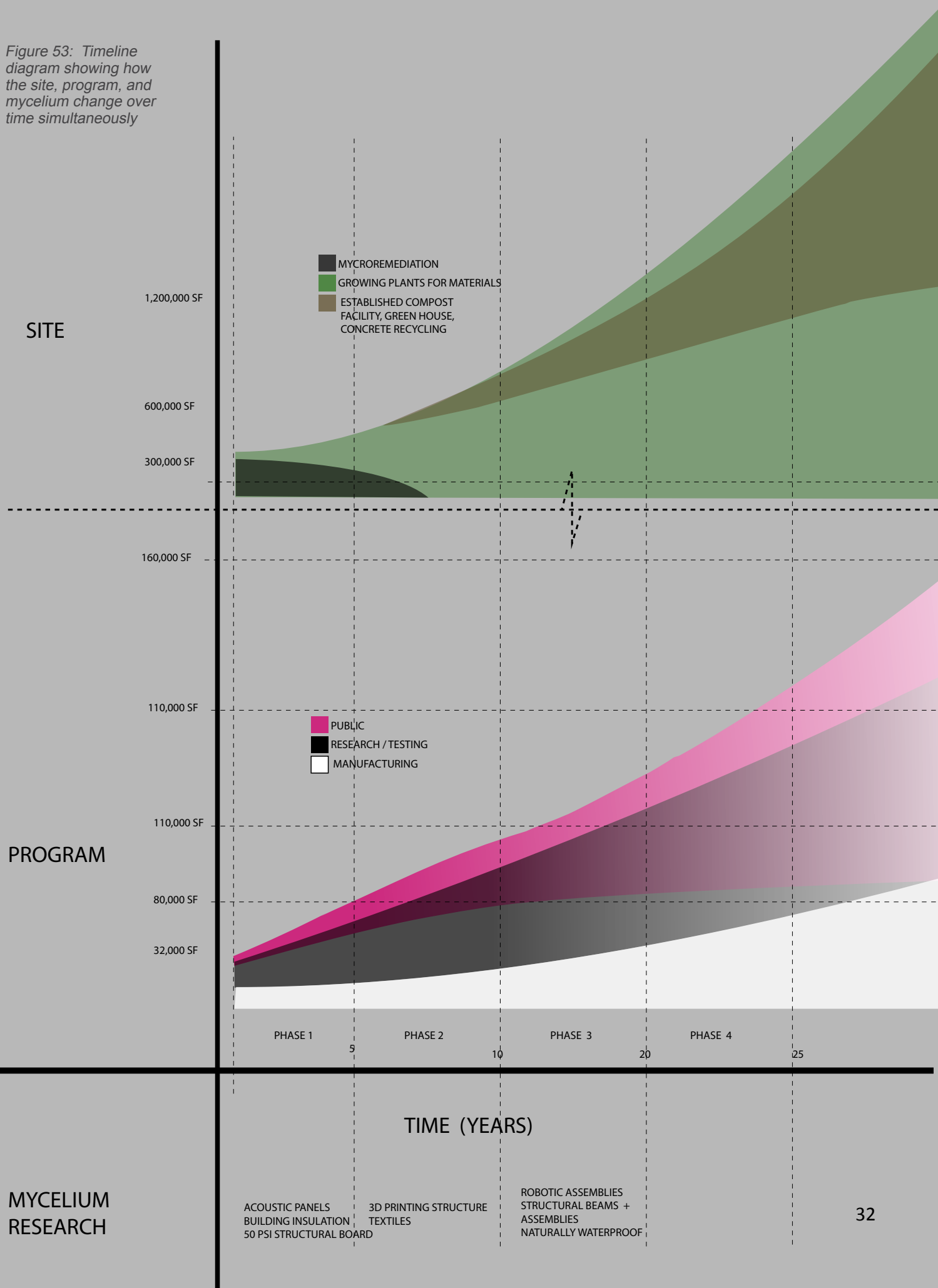

Figure 52: Composting

As the time goes forward mycelium research would become more advanced and allow the material to be used in the various areas of the building. In the program the public spaces grow in terms of square footage into the future and start to overlap with research and manufacturing of the material. This is a prediction that into the future the facility could become a place that has more spaces and activities for the public as the mycelium materials become more stable and manufacturing processes more efficient.

By incrementally growing the site and facility I can better predict future and space requirements. Also, as the mycelium material infrastructures become more advanced and can start to fill in as parts of the building that could become more types of interior applications as well as roofs, outdoor sun louvers, architectural textiles, and structural beams and columns. The three other existing buildings on the site could be refurbished to become places to recycled concrete material from the silo buildings, greenhouses to grow more agricultural products, and a composting facility.

Figure 53: Timeline diagram showing how the site, program, and mycelium change over time simultaneously



MYCELIUM INFRASTRUCTURES FOR IMPERMANENT FUTURES

AN EXISTING, UNUSED INDUSTRIAL SITE IS REVITALIZED
THROUGH THE PROCESS OF MANUFACTURING, RESEARCH,
AND TESTING OF A FUTURISTIC BIO-MATERIAL



Figure 54: Conceptual collage as part of the thesis poster. Collage shows how the three phases of the building were initially visualized. From cultivation and harvesting of an existing site, to manufacturing of the material, and future ideas of how technology and material research could shape the architecture.

The Vision and Application

The first step to implementing this model into my specific site was to look at the current Ecovative factory layout and machinery and see how it could be integrated into the silo building. Figure 55 shows an initial sketch that I did where I am thinking about how to integrate the factory into the silo building and how I could bring people in to see and experience not only the material going through the factory processes but also the material being applied architecturally in the form of insulation and acoustic panels in the makerspaces. A conceptual collage in Figure 54 envisions this past and future transformation.

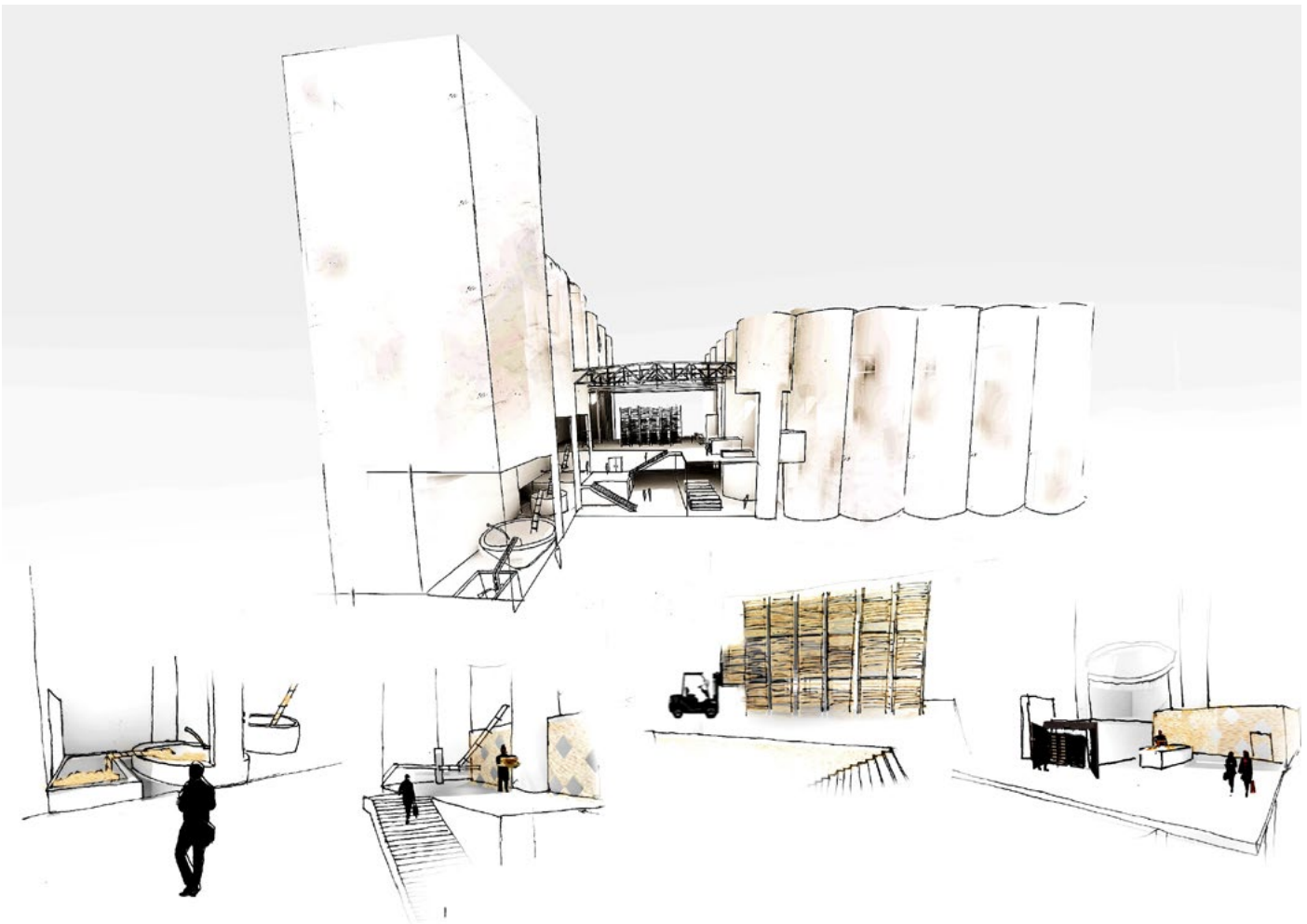

Figure 55: Sketch of building thinking of how the public could experience the factory and see the applications of the material

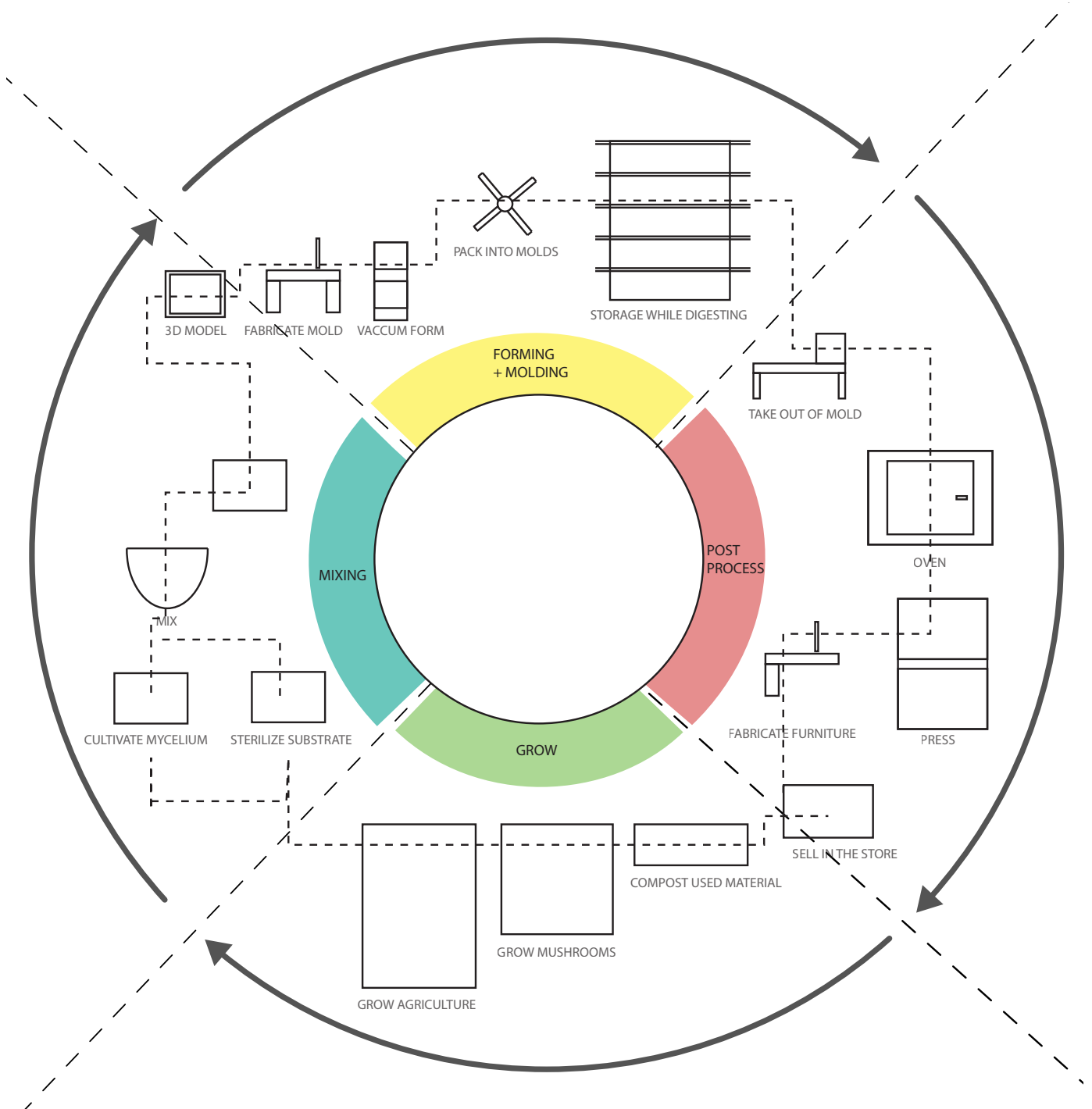

Figure 56: Program processes diagram showing the break down of the four essential stages in the manufacturing of the mycelium materials; grow - mixing- forming/molding - post processing.

Figure 56 is a manufacturing processes diagram that breaks down the equipment and flow of the factory. The challenge is then how to implement this diagram into the site and building. Figure 57 shows how utilizing the site and building as a host for this new factory. This model of integrating a new agricultural process into an existing agricultural building allows for some reuse of spaces and equipment. In this model the area where the mycelium is cultivated and the agricultural substrate chopped and processed would allow for the existing grain elevator and one of the grain silos to be reused for their original purpose. The remaining equipment and factory spaces would then occupy and span between the two existing silos buildings.

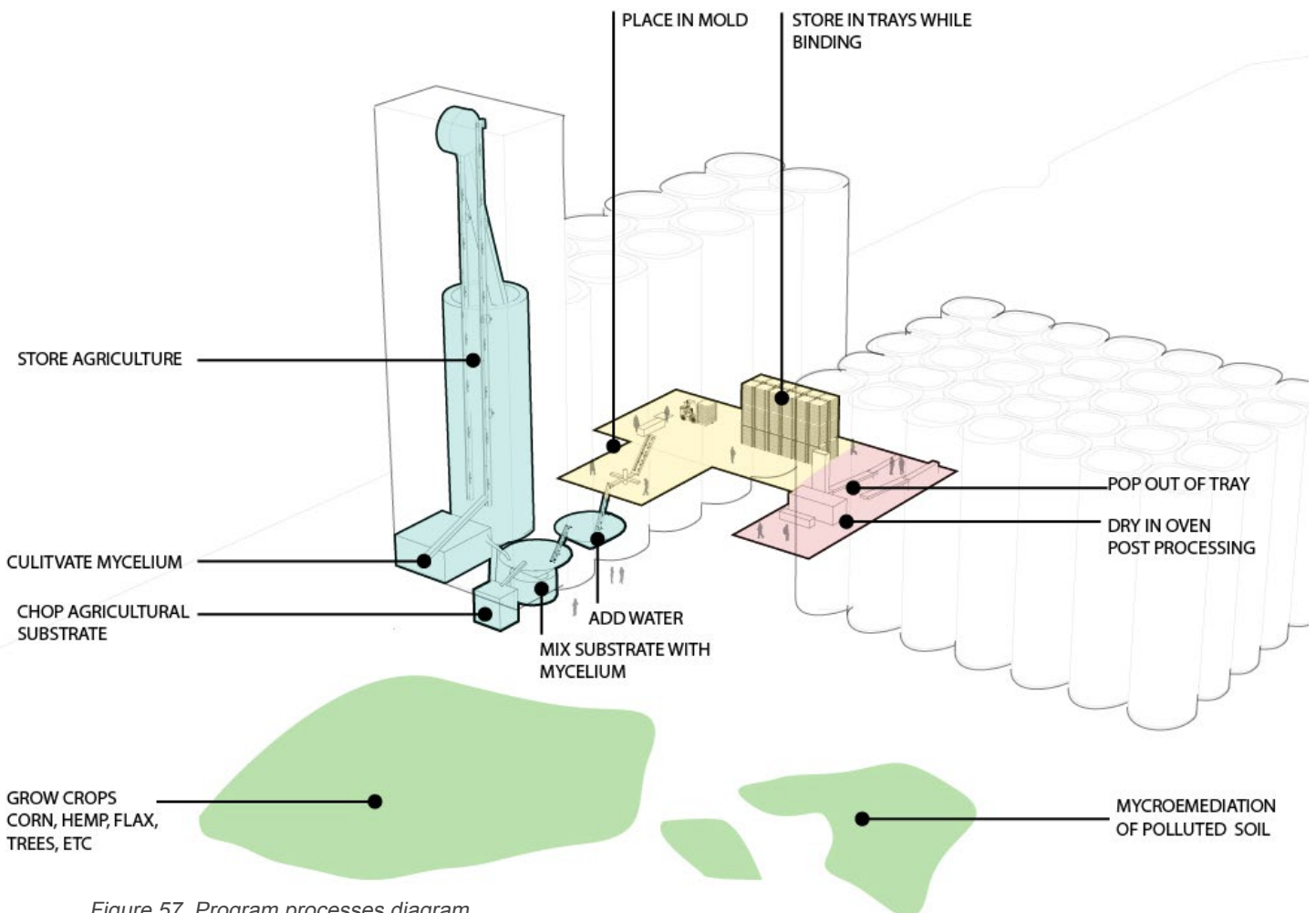

Figure 57 Program processes diagram applied to the site and existing building

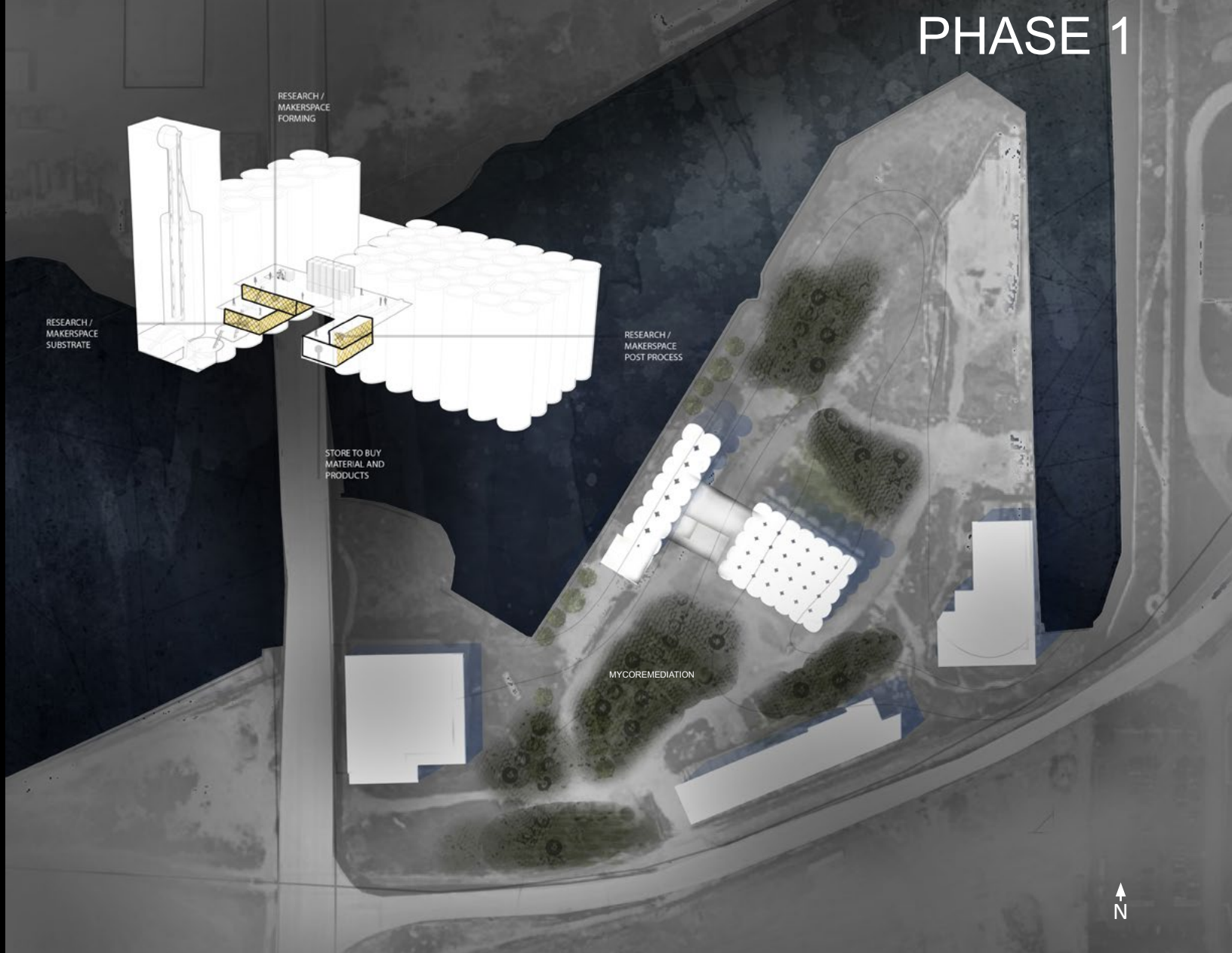

Figure 58: Phase 1 Site plan + building axonometric

The Phases of Development

Developing the project in a series of phases allows the future expansion and growth to be proposed and visualized. These proposals are based on current conditions of the site and the research of the material and predicted future applications. Phase 1 of the site and building development would be the initial advancement of the site remediation and building construction. The building program consists of the manufacturing and some research and makerspaces for the public. The healing of the industrial site would come in the form of mycoremediation (Figure 58).

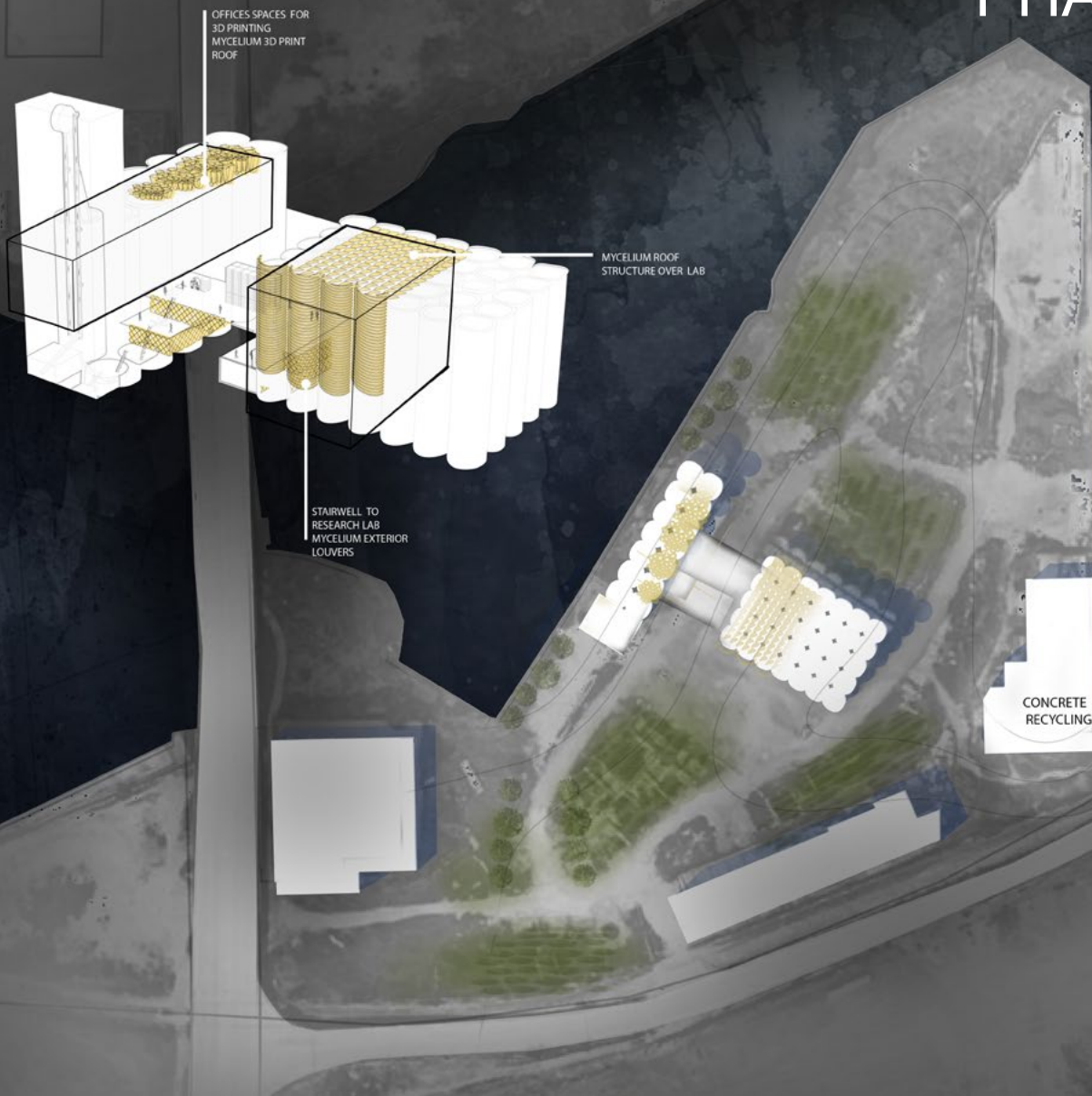

Figure 59: Phase 2 Site plan + building axonometric

Phase 2 of the project would be the expansion of the site to now allow for growing of crops on the previous sites of remediation. The building itself would start to expand out for new offices and research institutes. On the west wing there would be offices and testing of 3D printed roof structures. On the east wing there would be research institutes where testing roof structures and on the south facing facade with the most sun exposure there would be mycelium outdoor louver systems. In addition, the eastern most unused building on the site would become an area to recycle the excess concrete material that would then be used as aggregate in paving of the sites new roads and sidewalks.

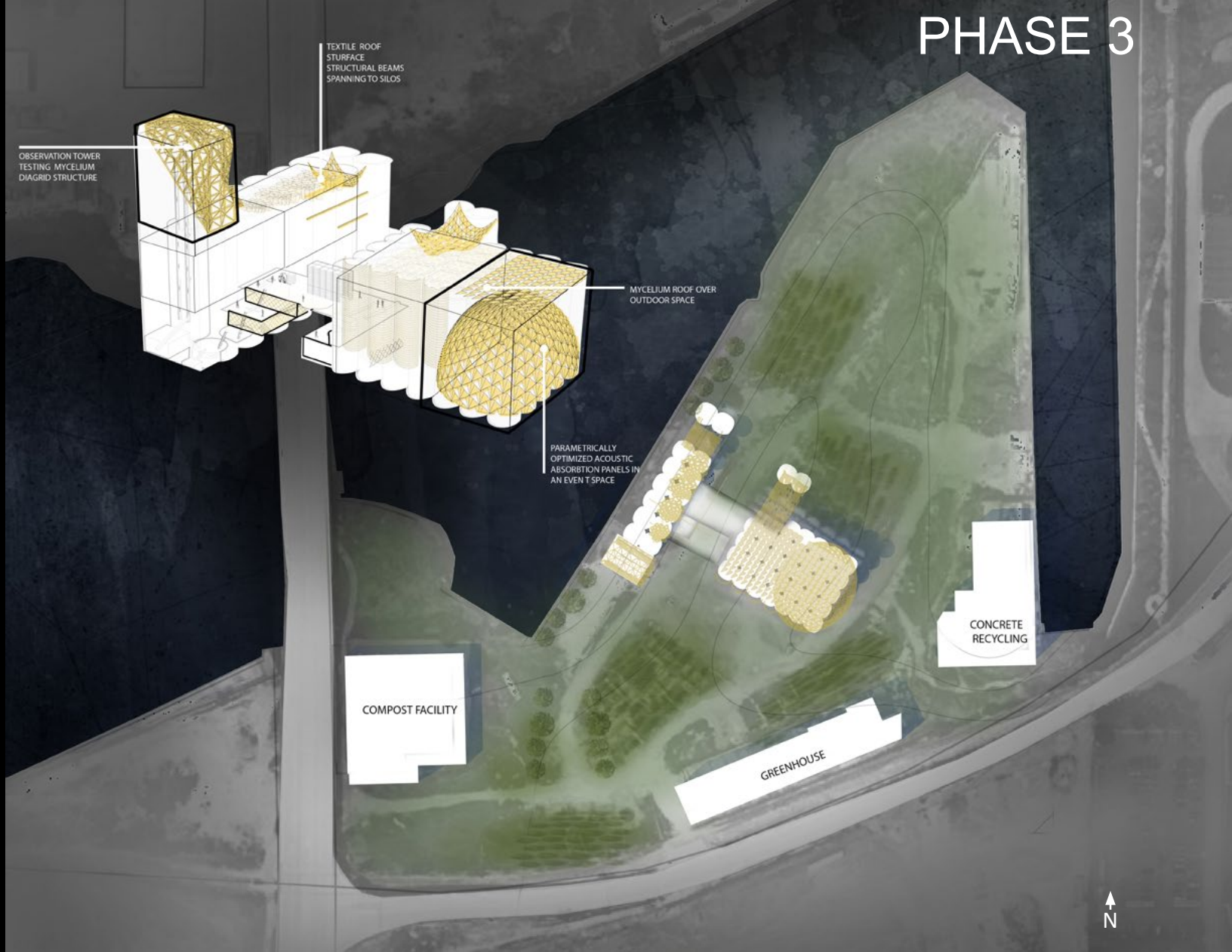

Figure 60: Phase 3 Site plan + building axonometric

Phase 3 consists of an overall expansion of the site development where plants are grown in all available areas of the site. The existing buildings on the site are also reused for not only concrete recycling but also as a greenhouse where the public could come in and grow food products as well as materials for the building and a composting facility in the last remaining building. Inside the program of the building becomes more focused on event and testing spaces for the material. On the west side there would be a public observation tower with a mycelium structural diagrid structure. On the east side of the building would be a place to test the acoustic panel performance in the form

of acoustic optimized panels. On the northern side of the structure there would be more expansion of the facility which would require physical moving of four of the silos outward. This would allow for structural mycelium infrastructures to be applied and tested and the existing silos would act as a structural scaffolding. There would also be testing of architectural textile materials in this area. There would be future phases of the building (phase 4,5,6,7,etc) where potentially the mycelium composite materials would become stable enough to build entire structures out of and the site and program would become something completely new. Figure 61, 62, and 63 show enlarged views of the building axons in order to see the material infrastructures and uses more clearly.

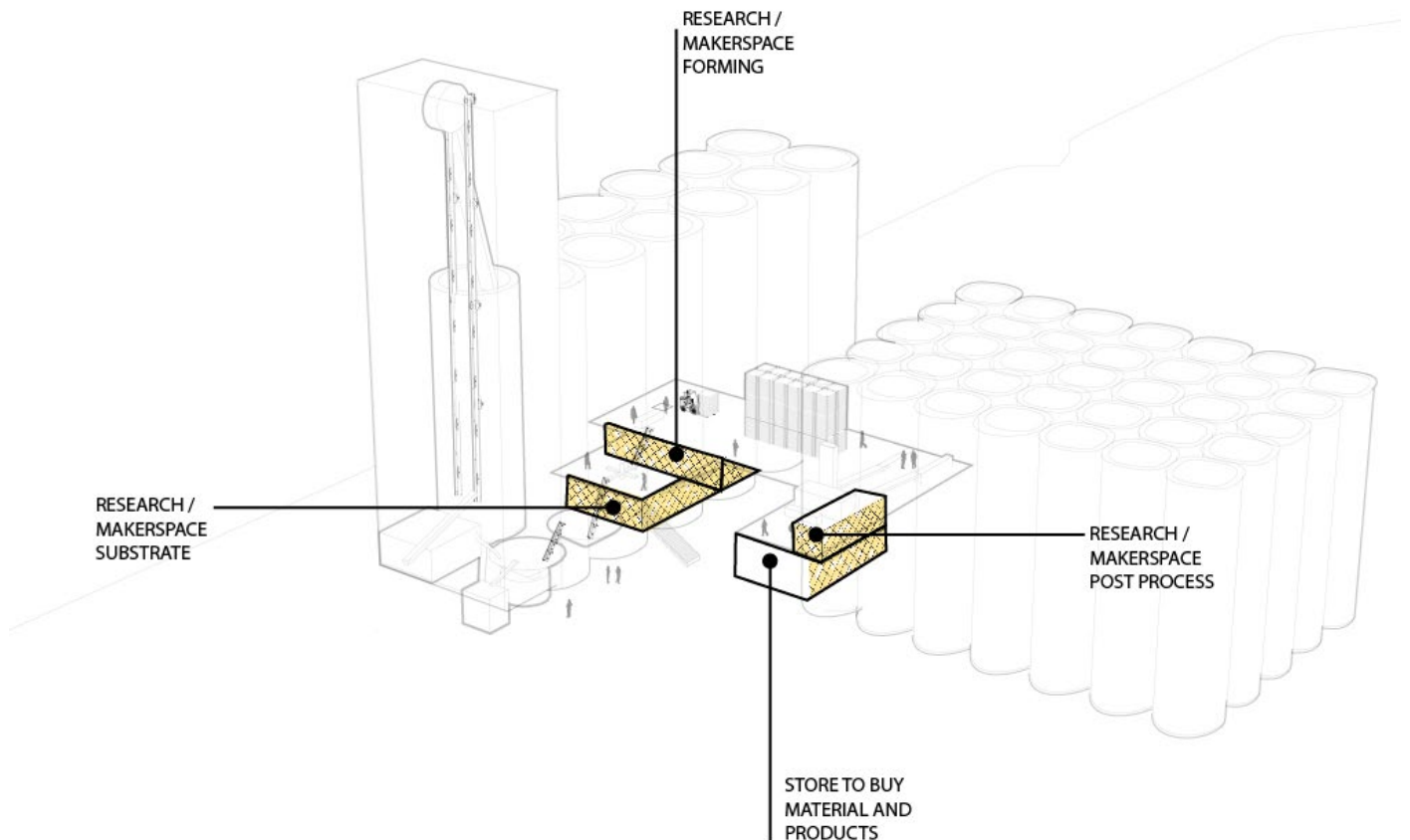

Figure 61: Phase 1 enlarged building axon

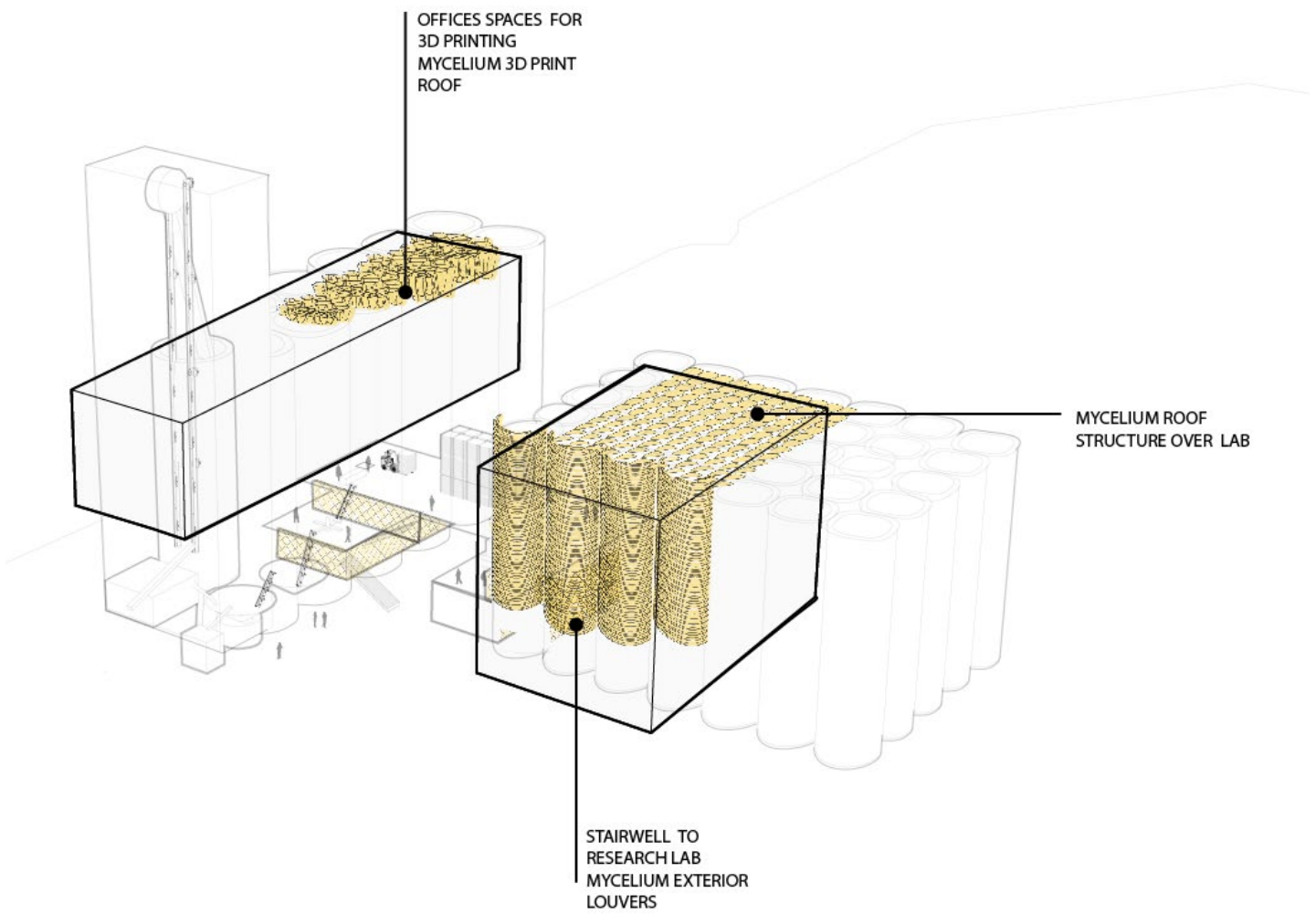

Figure 62: Phase 2 enlarged building axon

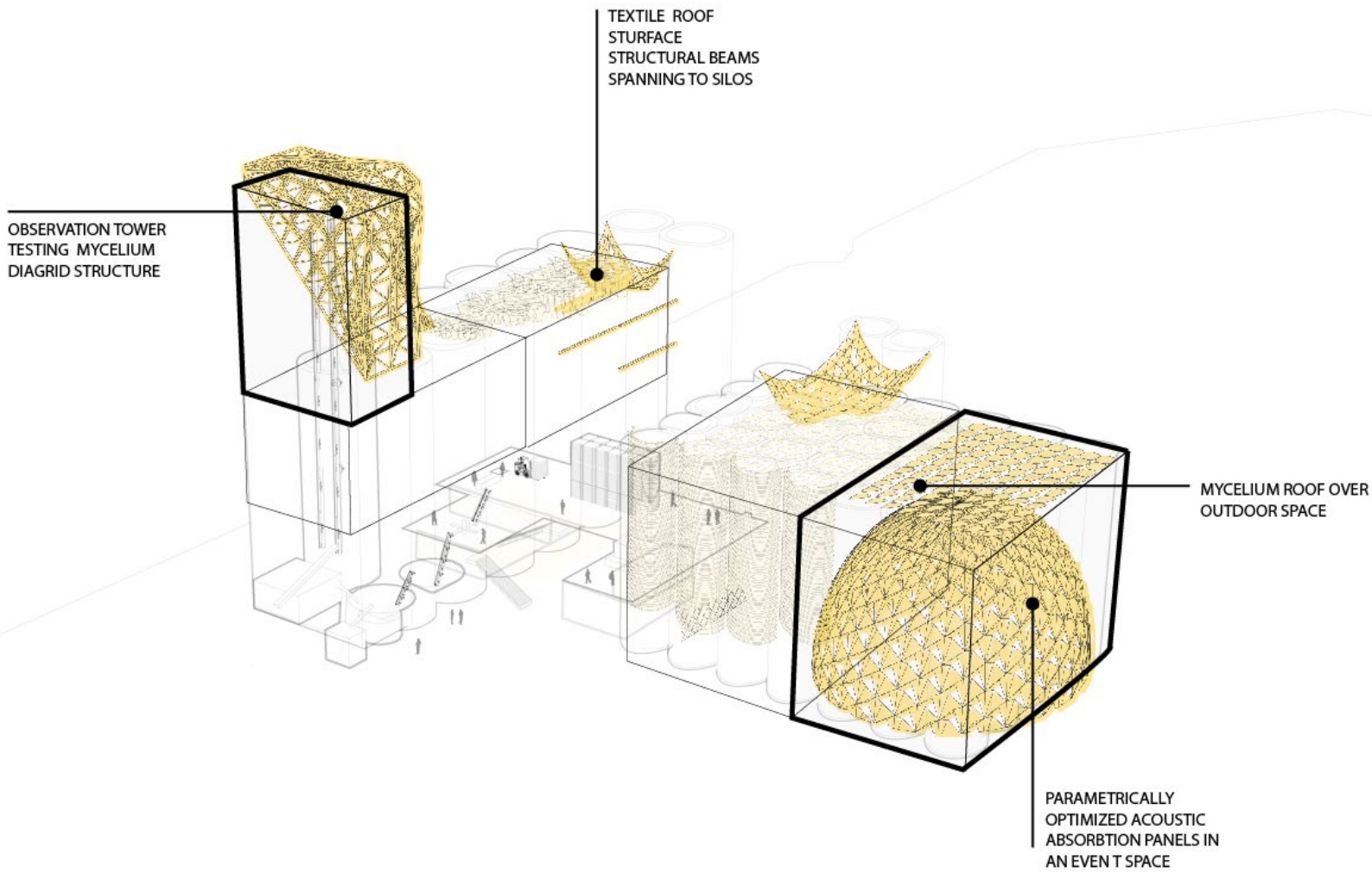

Figure 63: Phase 3 enlarged building axon

Visualizations of Change

On the following three pages there are a total of nine interior renders showing how the different spaces in the facility would change over time. All three phases are illustrated for each space and it shows that these spaces would change in terms of use of the program and the mycelium materials applications. They are illustrating a space that becomes fully developed in each phase. In Phase 1 the manufacturing is fully developed, in Phase 2 the office spaces are functional, and in Phase 3 the event space becomes open to the public. All three of these spaces show how the mycelium material can transform the evolving program. In all scenarios one can see that the spaces would change over time and become more established and slowly incorporate more program for the public as the mycelium material becomes more stable in its research and development.

By using the idea of incremental building in phases over time it facilitates the transformation of the program in accordance with what the future factory needs and the capabilities of the mycelium material. As the interior and exterior changes the mycelium material applications would be changed out and improved. They would be composted in the onsite compost area and then be naturally cycled back into becoming dirt for future material supplies to be grown.

PHASE 1

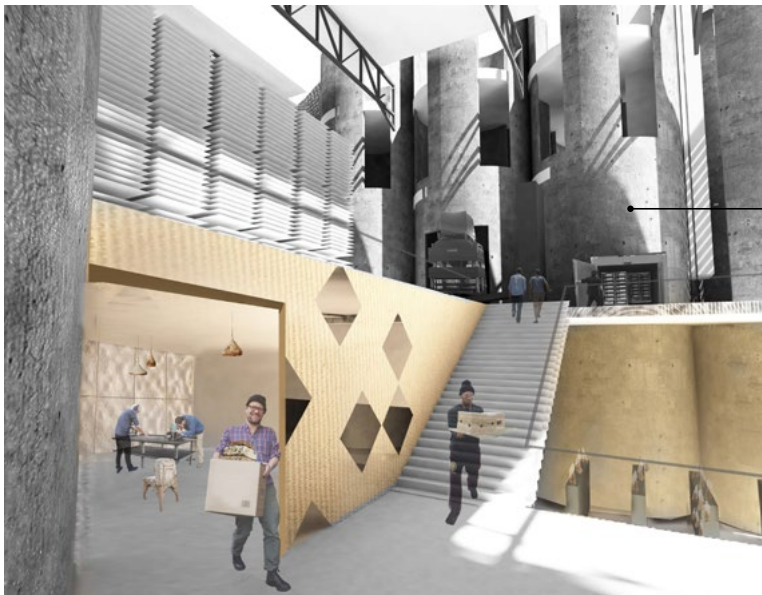

CURRENT MANUFACTURING

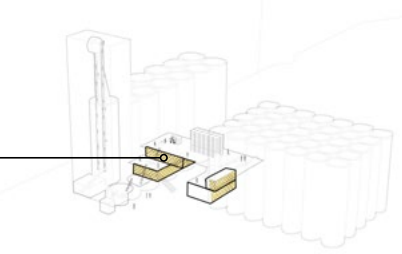
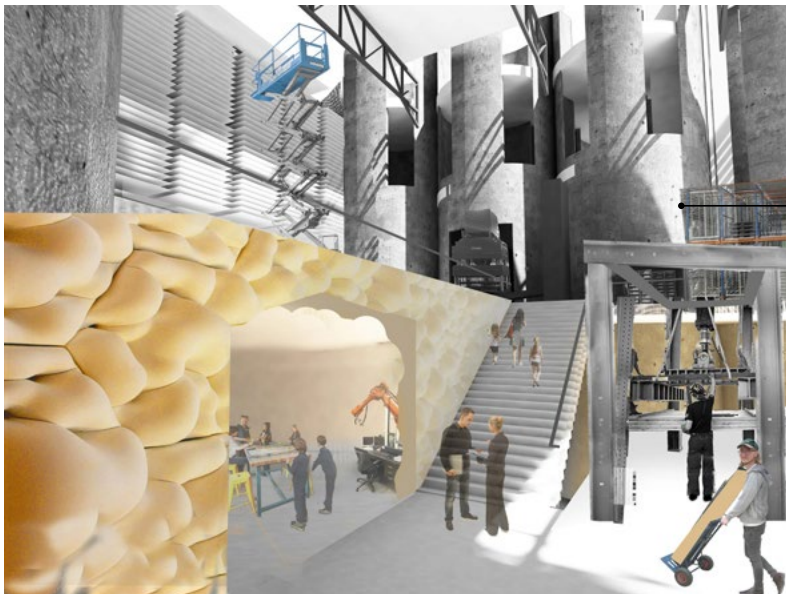

Figure 64: Rendered view looking into a makerspace and the factory processing above.

PHASE 2



FUTURE MANUFACTURING

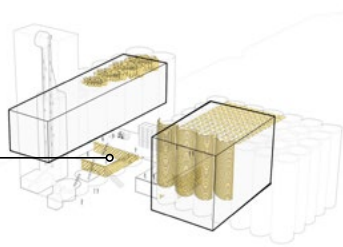

Figure 65: Factory equipment shifts to new processes, makerspace expanding out into facility.

PHASE 3



MANUFACTURING + PUBLIC MARKET

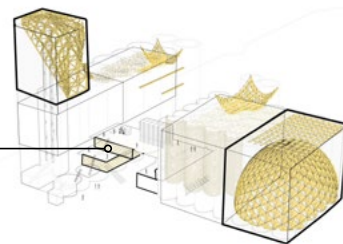
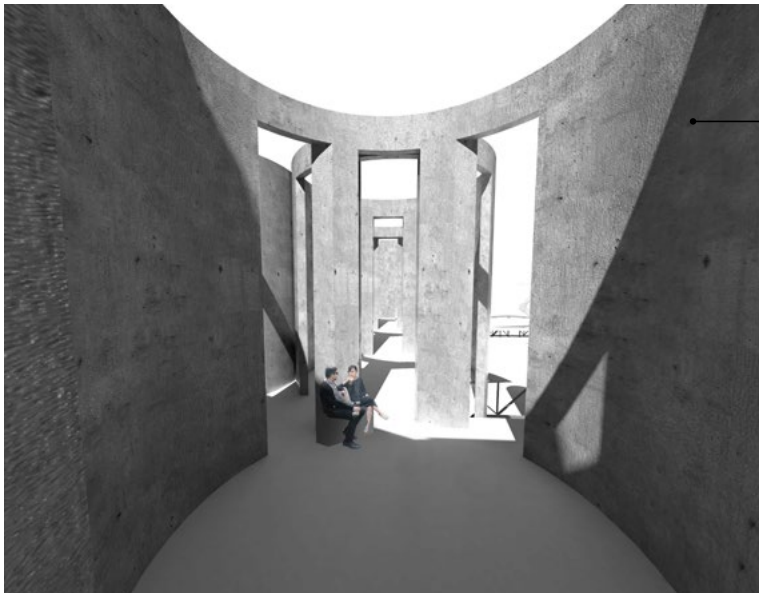

Figure 66: Facility shifts to a new place of selling materials and agricultural products that are grown on site

PHASE 1



FUTURE OFFICE

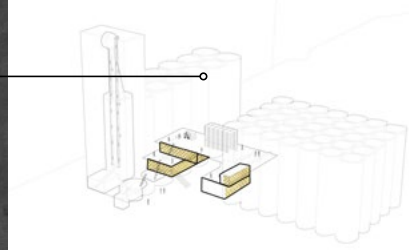
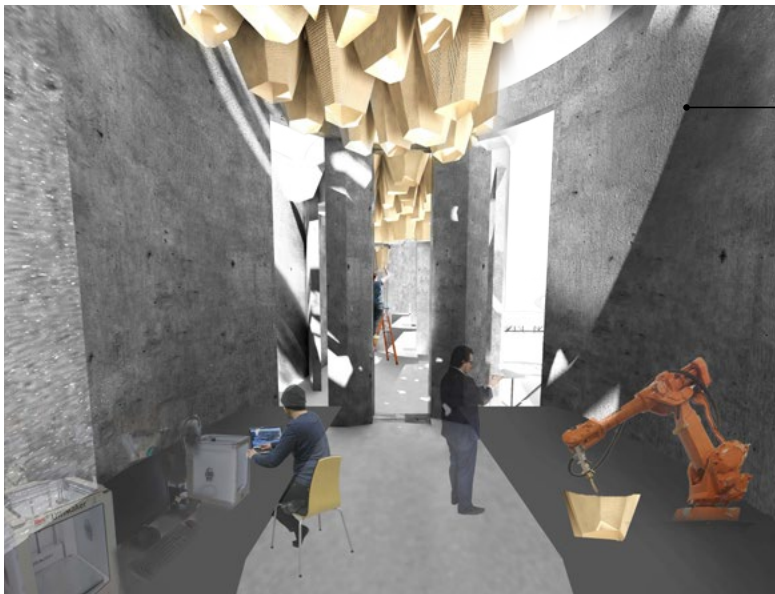

Figure 67: Future office space open to the air and light

PHASE 2



3D PRINT OFFICE

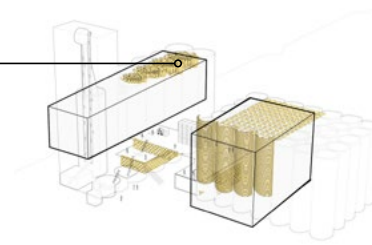

Figure 68: Office space being used as a place to study 3D printing and fabricate roof panels

PHASE 3



PUBLIC GROW SPACE

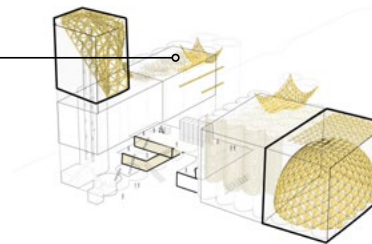
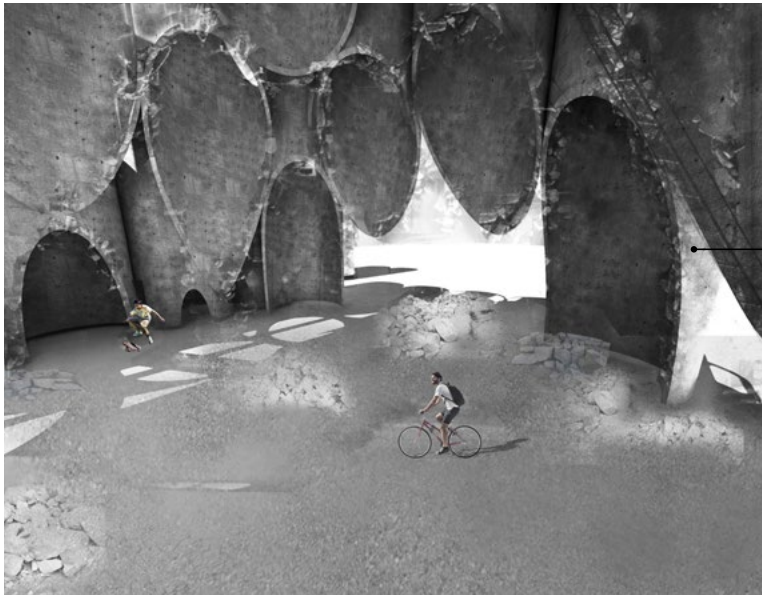

Figure 69: The 3D print office relocates to another part of the building and this room becomes a mushroom cultivation area.

PHASE 1



FUTURE TEST SPACE

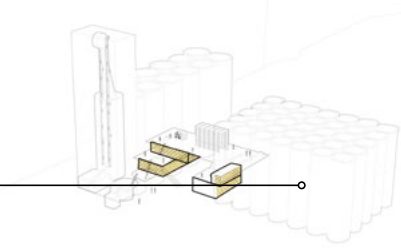
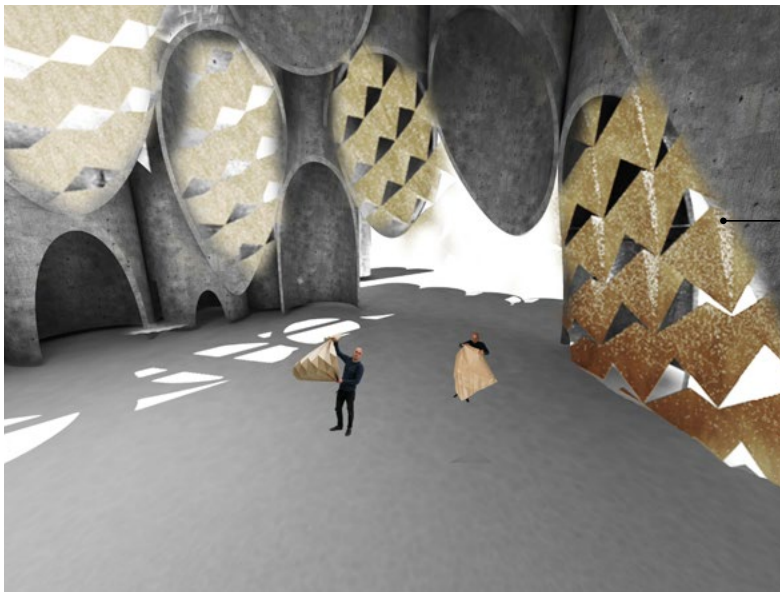

Figure 70: Rough cut future structure and acoustic panel testing

PHASE 2



TESTING ACOUSTIC PANELS

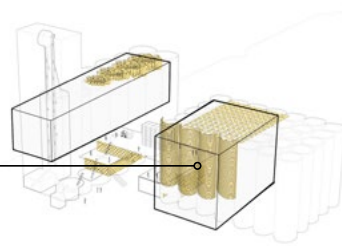
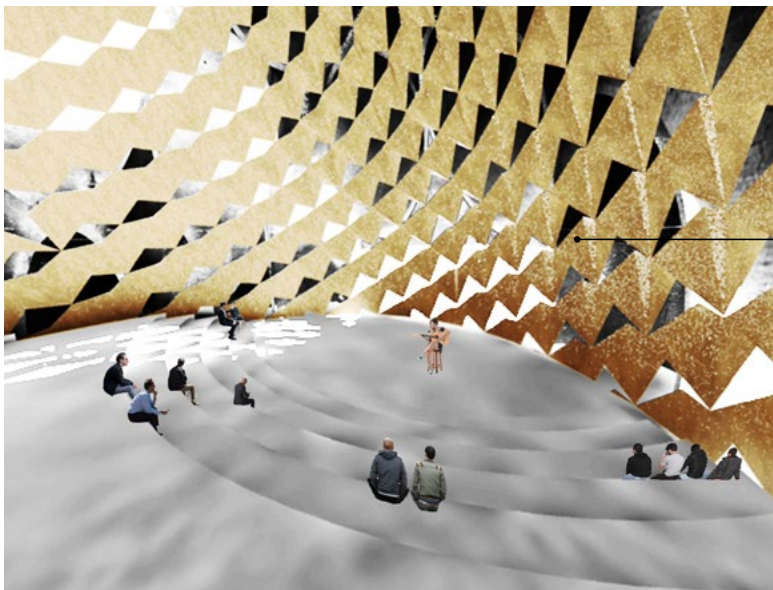

Figure 71: Area for testing parametrically optimized acoustic panel structures

PHASE 3



PUBLIC EVENT SPACE

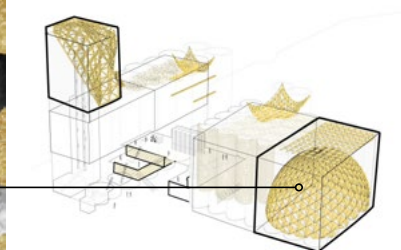
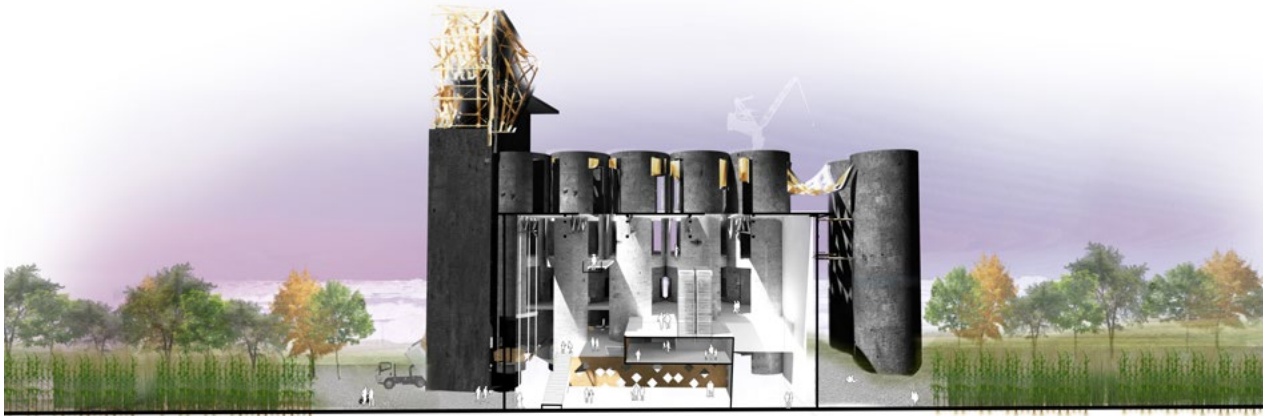

Figure 72: Developed acoustic space now open to the public for cultural events



EAST - WEST



NORTH - SOUTH

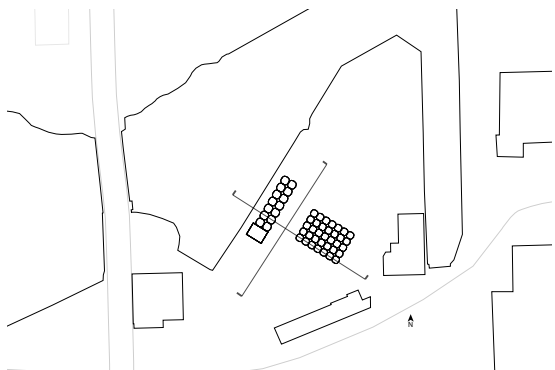

Figure 73: Site sections showing how the facility is under a constant state of construction and how the cycles of the site; concrete recycling, growing, and composting are located within close proximity to it.



Figure 74: Render view of the site and building during Phase 3 of construction

Conclusion

Through anticipation of change in a buildings use and future needs we can create buildings that are adaptable and flexible. All buildings change over time and nothing is ever finished. I am challenging the definition of “permanence” in architecture by seeking alternatives beyond material stability and lifespan that base a buildings longevity on it’s ability to adapt to change over time. By creating a facility and program that is inherently going to expand and change I can predict and anticipate future needs. The material mycelium is in a state of constant evolution where current research is evolving into a versatile, stable, technology driven building applications.

To reiterate a quote that I mentioned previously in the paper:

Antonio Sant’Elia wrote in 1914:

“...The fundamental characteristics of Futurist architecture will be its impermanence and transience. Things will endure less than us [sic]. Every generation must build its own city. This constant renewal of the architectonic environment will contribute to the victory of Futurism....”³⁹

This constant renewal is seen in both site and building. The site goes through a rebirth through remediation, growing, composting, and recycling concrete where no nutrients are wasted. Moving towards ideas of building cycles that are closed-loop and ‘upcycled’ can aid in the minimization of waste that is produced from construction and demolition of buildings. In

addition, the idea of harvesting, cultivating, and 'urban mining' building materials on a site can greatly decrease the energy intensive extraction of natural resources and transportation. Grain elevators and silos are a resource for future building and through my investigation I have found that the adaptive reuse of them is entirely possible and inherently beneficial. Disassembly, reuse, and reassembly are ideas that can aid in creating a sustainable future for generations to come.

This project also emphasizes that this strategy would incorporate advancements in technology (3D printing, textile architecture, robotic construction assemblies, structural optimization, etc) because of the potentials of current architectural research in those fields. The program of manufacturing, research, and testing in the building and site focuses on bringing all these advancements together in one place to create prolific breakthroughs with the mycelium based bio-composite materials. It is fundamental that we use the tools we have to advance our building materials and sustain our future.

As with the building and rebuilding cycle of Jingu Shrine in Ise City, Japan, this project would also gain a infinite future and for the people involved it would create a reverence for life. Therefore, through using a material that is part of a renewable, closed loop cycle and a building program that is certain to change, permanence is obtained and change is celebrated.

LIST OF FIGURES:
All figures are by the author unless otherwise noted.

Figure 1: Aerobic bacteria (*What makes Compost? Microorganisms that Make Rot Happen.*)

Figure 2: Image from the film *Wall-E*. (*Gallery of 4 Lessons Pixar Films Can Teach Us About Architecture*)

Figure 3: Re-imaging Brooklyn of the future with waste (Joachim)

Figure 4: A tower made from one day of 36,200 tons of waste (Joachim)

Figure 5: Timeline of the future of refuse (Joachim)

Figure 6: Layers of a building diagram (Brand)

Figure 7: Jingu Shrine (“Rebuilding Every 20 Years Renders Sanctuaries Eternal -- the Sengu Ceremony at Jingu Shrine in Ise□JFS Japan for Sustainability.”)

Figure 8: Citizens participate in ceremony (“Rebuilding Every 20 Years Renders Sanctuaries Eternal -- the Sengu Ceremony at Jingu Shrine in Ise□JFS Japan for Sustainability.”)

Figure 9: Re-interpretation of the ‘Shearing Layers of Change’ diagram using material lifespan

Figure 10: Grain Elevator locations (“*American Colossus: The Grain Elevator.*”)

Figure 11: Grain elevator and silo section.

Figure 12: Comparing the ‘Shearing Layers of Change’ diagram to a silo

Figure 13: Historic site axon (“*New Grain Elevator for the Sante Fe System at Chicago.*”)

Figure 14: Historic site plan (“*New Grain Elevator for the Sante Fe System at Chicago.*”)

Figure 15: The site in relation to the downtown Chicago Loop and industrial corridor.

Figure 16: The site today (“*Damen, Silos.*”)

Figure 17: The site analysis maps. (base map from Google Earth)

Figure 18: Axon view of the site (base map from Google Earth)

Figure 19: Mushroom block by Philip Ross

Figure 20: “Mycotecture” art installation by Philip Ross (*Mycotecture: Building with Mushrooms? This Inventor Says Yes | TreeHugger*)

Figure 21: Ecovative’s Mushroom Tiny House (*Ecovative.com*)

Figure 22: Mycelium insulation material (*Ecovative.com*)

Figure 23: Hy-Fi Project (“*Behind ‘Hy-Fi’: The Organic, Compostable Tower That Won MoMA PS1’s Young Architects Program 2014.*”)

Figure 24: Hy-Fi Project brick molds (“*Behind ‘Hy-Fi’: The Organic, Compostable Tower That Won MoMA PS1’s Young Architects Program 2014.*”)

Figure 25: Render of Hy-Fi (“*Behind ‘Hy-Fi’: The Organic, Compostable Tower That Won MoMA PS1’s Young Architects Program 2014.*”)

LIST OF FIGURES:
All figures are by the author unless otherwise noted.

- Figure 26: *Far Left: Fire resistance testing at Ecovative (Ecovative.com)
Testing the compressive strength at Columbia University Laboratory (Clark , Matt, and Shaina Saporta)*
- Figure 27: *MycoTree polyhedral structural form diagram (Mele, Tom Van)*
- Figure 28: *MycoTree final structure (Mele, Tom Van)*
- Figure 29: *MycoTree component fabrication (Mele, Tom Van)*
- Figure 30: *Mycelium structural beam (Ecovative.com)*
- Figure 31: *Mycelium structural panel (Ecovative.com)*
- Figure 32: *Mycelium textile material (Ecovative.com)*
- Figure 33: *Mycelium-based textile dress by NEFFA
(MycoTEX proof-of-concept |NEFFA)*
- Figure 34: *Textile material testing by NEFFA (MycoTEX proof-of-concept |NEFFA)*
- Figure 35: *Ecovative compost research (Ecovative.com)*
- Figure 36: *3-D printed mycelium chair (Mycelium Chair by Eric Klarenbeek is 3D-printed with living fungus.)*
- Figure 37: *3-D printed segment of straw core. (Mycelium Chair by Eric Klarenbeek is 3D-printed with living fungus.)*
- Figure 38: *Ecovative factory located in Green Island, NY (Ecovative.com)*
- Figure 39: *Ecovative factory processes and equipment*
- Figure 40: *Program proposal diagrams*
- Figure 41: *Program proposal diagrams incorporating public involvement*
- Figure 42: *Heatherwick Studio - Zeitz MOCAA art galleries- Cape Town, reuse of a 1920 grain silo (“Zeitz Museum of Contemporary Art Africa / Heatherwick Studio”)*
- Figure 43: *Heatherwick Studio - Zeitz MOCAA art galleries- interior atrium (“Zeitz Museum of Contemporary Art Africa / Heatherwick Studio”)*
- Figure 44: *Heatherwick Studio - Zeitz MOCAA art galleries- interior atrium cut out (“Zeitz Museum of Contemporary Art Africa / Heatherwick Studio”)*
- Figure 45: *Moving of a silo at Kreider Farms in Manheim, PA to create an observation tower (Coffeen)*
- Figure 46 : *Sunlight analysis of summer solstice (made using Ladybug for Grasshopper)*
- Figure 47: *Diagram showing cutting and removing parts of the silos*
- Figure 48: *Diagram showing resulted skeletal structure*
- Figure 49: *Concrete Recycling (Google Images)*
- Figure 50: *Mycoremediation (Google Images)*
- Figure 51: *Planting (Google Images)*
- Figure 52: *Composting (Google Images)*

LIST OF FIGURES:
All figures are by the author unless otherwise noted.

Figure 53: Timeline diagram showing how the site, program, and mycelium change over time simultaneously

Figure 54: Conceptual collage as part of the thesis poster.

Figure 55: Sketch of building thinking of how the public could experience the factory and see the applications of the material

Figure 56: Program processes diagram showing the break down of the four essential stages in the manufacturing of the mycelium materials; grow - mixing- forming/molding - post processing.

Figure 57: Program processes diagram applied to the site and existing building

Figure 58: Phase 1 Site plan + building axonometric

Figure 59: Phase 2 Site plan + building axonometric

Figure 60: Phase 3 Site plan + building axonometric

Figure 61: Phase 1 enlarged building axon

Figure 62: Phase 2 enlarged building axon

Figure 63: Phase 3 enlarged building axon

Figure 64: Rendered view looking into a makerspace and the factory processing above.

Figure 65: Factory equipment shifts to new processes, makerspace expanding out into facility.

Figure 66: Facility shifts to a new place of selling materials and agricultural products that are grown on site

Figure 67: Future office space open to the air and light

Figure 68: Office space being used as a place to study 3D printing and fabricate roof panels

Figure 69: The 3D print office relocates to another part of the building and this room becomes a mushroom cultivation area.

Figure 70: Rough cut future structure and acoustic panel testing

Figure 71: Area for testing parametrically optimized acoustic panel structures

Figure 72: Developed acoustic space now open to the public for cultural events

Figure 73: Site sections showing how the facility is under a constant state of construction and how the cycles of the site; concrete recycling, growing, and composting are located within close proximity to it.

Figure 74: Render view

ENDNOTES

- 1 “Q&A: Ken Yeang Interview.” CNN, Cable News Network, 7 July 2007, www.cnn.com/2007/TECH/science/07/16/yeang.qa/.
- 2 “Composting Is the Aerobic Decomposition of Biodegradable Organic Matter, Producing Compost.” Composting 101 , www.talgov.com/Uploads/Public/Documents/you/learn/library/documents/composting101.pdf.
- 3 William McDonough, and Michael Braungart. *The Upcycle*. North Point Press, 2013. Pg. 5.
- 4 “Sustainable Management of Construction and Demolition Materials.” EPA, Environmental Protection Agency, 9 Feb. 2018, www.epa.gov/smm/sustainable-management-construction-and-demolition-materials.
- 5 Nadav Malin. “California Law Uses Environmental Product Declarations to Drive Low-Carbon Procurement.” *BuildingGreen*, 3 Nov. 2017, www.buildinggreen.com/news-analysis/california-law-uses-environmental-product-declarations-drive-low-carbon-procurement.
- 6 “Beyond Mining - Urban Growth at Seoul Biennale.” *Beyond Mining - Urban Growth at Seoul Biennale – Future Cities Laboratory | ETH Zurich*, 5 Sept. 2017, www.fcl.ethz.ch/news/news/2017/09/beyond-mining-urban-growth-seoul-biennale.html.
- 7 “Featured Actions.” *Art Works for Change*, www.artworksforchange.org/portfolio/mitchell-joachim-and-terreform-one/.
- 8 Dirk Hebel. *Building from Waste: Recovered Materials in Architecture and Construction*. Basel ; Boston : Birkhäuser, 2014. Pg. 15, 16.
- 9 i.b.i.d. Pg. 14.
- 10 Joachim, Mitchell. “RAPID RE(F)USE: WASTE TO RESOURCE CITY 2120.” *Terreform*, www.terreform.org/projects_urbanity_rapid_refuse.html.
- 11 Dirk Hebel. *Building from Waste: Recovered Materials in Architecture and Construction*. Basel ; Boston : Birkhäuser, 2014. Pg. 21.
- 12 Robert U Ayres . “On the Life Cycle Metaphor: Where Ecology and Economics Diverge.” *Ecological Economics*, vol. 48, no. 4, 2004, pp. 425–438., doi:10.1016/j.ecolecon.2003.10.018. (pg 427)
- 13 Berge, Bjorn. *Ecology of Building Materials*. Routledge, 2017. Pg. 23.
- 14 i.b.i.d. Pg. 29.
- 15 i.b.i.d. Pg. 30.
- 16 Stewart Brand. *How Buildings Learn: What Happens after They’re Built*. Penguin Books, 2012. Ch. 2 Shearing Layers.
- 17 Antonio Sant’Elia, “Manifesto of Futurist Architecture,” 1913, reprinted in *Futurist Manifestos*, Umbro Apollonio, ed. (New York: Viking, 1970), pg 172.
- 18 “Rebuilding Every 20 Years Renders Sanctuaries Eternal -- the Sengu Ceremony at Jingu Shrine in Ise □JFS Japan for Sustainability.” *JFS Japan for Sustainability*, Aug. 2013, www.japanfs.org/en/news/archives/news_id034293.html.
- 19 “New Grain Elevator for the Sante Fe System at Chicago.” *The Railway Age* (1900-1908); Mar 23, 1906; 41,12; *American Periodicals* (pg. 408)

ENDNOTES

- 20** Mohammad Farid Alvansaz Yazdi, et al. "Bio-Composite Materials Potential in Enhancing Sustainable Construction." *Desalination and Water Treatment*, vol. 52, no. 19-21, 2013, pp. 3631–3636., doi:10.1080/19443994.2013.854105. Pg. 3632.
- 21.** i.b.i.d. Pg. 3633.
- 22** Ecovative | Mycelium Biomaterials, Green Island, New York, ecovatedesign.com/.
- 23** i.b.i.d.
- 24** Adam Fisher. "Industrial-Strength Fungus." *Time*, Time Inc., 8 Feb. 2010, content.time.com/time/magazine/article/0,9171,1957474,00.html.
- 25** M. Chandra, C. Kohn, J. Pawlitz, & G. Powell, (2016). Real Cost of Styrofoam. Saint Louis University, Retrieved from https://greendiningalliance.org/wp-content/uploads/2016/12/real-cost-of-styrofoam_written-report.pdf
- 26** "Is Mushroom Insulation the World's Greenest Insulating Material?" *Energy Vanguard*, 17 July 2013, www.energyvanguard.com/blog/65314/Is-Mushroom-Insulation-the-World-s-Greenest-Insulating-Material
- 27** Ecovative | Mycelium Biomaterials, Green Island, New York, ecovatedesign.com/.
- 28** i.b.i.d.
- 29** "Behind 'Hy-Fi': The Organic, Compostable Tower That Won MoMA PS1's Young Architects Program 2014." *ArchDaily*, 17 Feb. 2014, www.archdaily.com/477912/behind-hy-fi-the-entirely-organic-compostable-tower-that-won-moma-ps1-young-architect-s-program-2014/.
- 30** i.b.i.d.
- 31** "The Future of Construction: Mushroom Buildings." *Interesting Engineering*, 11 Mar. 2018, interestingengineering.com/future-construction-mushroom-buildings.
- 32** Tom Van Mele. "MycoTree - Seoul Biennale for Architecture and Urbanism 2017." *Block Research Group*, www.block.arch.ethz.ch/brg/project/mycotree-seoul-architecture-biennale-2017.
- 33** Tom Van Mele. "MycoTree - Seoul Biennale for Architecture and Urbanism 2017." *Block Research Group*, www.block.arch.ethz.ch/brg/content/project/mycotree-seoul-architecture-biennale-2
- 34** "Beyond Mining - Urban Growth at Seoul Biennale." *Beyond Mining - Urban Growth at Seoul Biennale – Future Cities Laboratory | ETH Zurich*, www.fcl.ethz.ch/news/news/2017/09/beyond-mining-urban-growth-seoul-biennale.html.
- 35** Ecovative | Mycelium Biomaterials, Green Island, New York, ecovatedesign.com/.
- 36** MycoTEX proof-of-concept | NEFFA. (n.d.). Retrieved March 13, 2018, from <https://neffa.nl/portfolio/mycotex/>
- 37** Exhibition - Fungal Futures. (n.d.). Retrieved March 13, 2018, from <http://www.fungal-futures.com/Exhibition>
- 38** "Mycelium Chair by Eric Klarenbeek is 3D-printed with living fungus." (n.d.). *Dezeen*, Retrieved March 13, 2018, from <https://www.dezeen.com/2013/10/20/mycelium-chair-by-eric-klarenbeek-is-3d-printed-with-living-fungus/>
- 39** Antonio Sant'Elia, "Manifesto of Futurist Architecture," 1913, reprinted in *Futurist Manifestos*, Umbro Apollonio, ed. (New York: Viking, 1970), pg 172.

WORKS CITED

“American Colossus: The Grain Elevator.” American Colossus: The Grain Elevator, 1 Jan. 1970, american-colossus.blogspot.com/2009_03_29_archive.html.

Ayres, Robert U. “On the Life Cycle Metaphor: Where Ecology and Economics Diverge.” *Ecological Economics*, vol. 48, no. 4, 2004, pp. 425–438., doi:10.1016/j.ecolecon.2003.10.018.

“Behind ‘Hy-Fi’: The Organic, Compostable Tower That Won MoMA PS1’s Young Architects Program 2014.” *ArchDaily*, 17 Feb. 2014, www.archdaily.com/477912/behind-hy-fi-the-entirely-organic-compostable-tower-that-won-moma-ps1-young-architect-s-program-2014/.

“Beyond Mining - Urban Growth at Seoul Biennale.” *Beyond Mining - Urban Growth at Seoul Biennale – Future Cities Laboratory | ETH Zurich*, 5 Sept. 2017, www.fcl.ethz.ch/news/news/2017/09/beyond-mining-urban-growth-seoul-biennale.html.

Bjorn Berge. *Ecology of Building Materials*. Routledge, 2017

Clark , Matt, and Shaina Saporta. “Arup Engineers Explain: How the MoMA PS1 YAP Winners Grew Ten Thousand Mushroom Bricks.” *ArchDaily*, 25 June 2014, www.archdaily.com/520763/arup-engineers-explain-how-the-moma-ps1-yap-winners-grew-ten-thousand-mushroom-bricks.

Chandra, M., Kohn, C., Pawlitz, J., & Powell, G. (2016). *Real Cost of Styrofoam*. Saint Louis University, Retrieved from https://greendiningalliance.org/wp-content/uploads/2016/12/real-cost-of-styrofoam_written-report.pdf

Coffeen, Peggy. (2017). “Best Builds: Kreider Farms’ silo gives guests a view of Lancaster County” *Progressive Dairyman*. Retrieved March 14, 2018, from <https://www.progressivedairy.com/topics/barns-equipment/best-builds-kreider-farms-silo-gives-guests-a-view-of-lancaster-county>

“Composting Is the Aerobic Decomposition of Biodegradable Organic Matter, Producing Compost.” *Composting 101* , www.talgov.com/Uploads/Public/Documents/you/learn/library/documents/composting101.pdf.

“Damen,Silos.” *The World’s Best Photos of Damen and Silos - Flickr Hive Mind*, hiveminer.com/Tags/damen%2Csilos.

Ecovative | Mycelium Biomaterials, Green Island, New York, ecovatedesign.com/.

Exhibition - Fungal Futures. (n.d.). Retrieved March 13, 2018, from <http://www.fungal-futures.com/Exhibition>

WORKS CITED

“Featured Actions.” Art Works for Change, www.artworksforchange.org/portfolio/mitchell-joachim-and-terreform-one/.

Fisher, Adam. “Industrial-Strength Fungus.” Time, Time Inc., 8 Feb. 2010, content.time.com/time/magazine/article/0,9171,1957474,00.html.

Gallery of 4 Lessons Pixar Films Can Teach Us About Architecture - 4. (n.d.). Retrieved March 13, 2018, from <https://www.archdaily.com/771987/4-lessons-pixar-films-can-teach-us-about-architecture/55d1dcf7e58eceab8c000066-4-lessons-pixar-films-can-teach-us-about-architecture-photo>

Hebel, Dirk. Building from Waste: Recovered Materials in Architecture and Construction. Basel ; Boston : Birkhäuser, 2014.

“Is Mushroom Insulation the World’s Greenest Insulating Material?” Energy Vanguard, 17 July 2013, www.energyvanguard.com/blog/65314/Is-Mushroom-Insulation-the-World-s-Greenest-Insulating-Material

Malin, Nadav. “California Law Uses Environmental Product Declarations to Drive Low-Carbon Procurement.” BuildingGreen, 3 Nov. 2017, www.buildinggreen.com/news-analysis/california-law-uses-environmental-product-declarations-drive-low-carbon-procurement.

McDonough, William, and Michael Braungart. The Upcycle. North Point Press, 2013.

Mele, Tom Van. “MycoTree - Seoul Biennale for Architecture and Urbanism 2017.” Block Research Group, www.block.arch.ethz.ch/brg/project/mycotree-seoul-architecture-biennale-2017.

“Mycelium Chair by Eric Klarenbeek is 3D-printed with living fungus.” (n.d.). Dezeen, Retrieved March 13, 2018, from <https://www.dezeen.com/2013/10/20/mycelium-chair-by-eric-klarenbeek-is-3d-printed-with-living-fungus/>

“Mycotecture: Building with Mushrooms?” This Inventor Says Yes | TreeHugger. (n.d.). Retrieved March 13, 2018, from <https://www.treehugger.com/green-architecture/mycotecture-mushroom-bricks-philip-ross.html>

MycoTEX proof-of-concept | NEFFA. (n.d.). Retrieved March 13, 2018, from <https://neffa.nl/portfolio/mycotex/>

“New Grain Elevator for the Sante Fe System at Chicago.” The Railway Age (1900-1908); Mar 23, 1906; 41,12; American Periodicals (pg. 408)

WORKS CITED

“Q&A: Ken Yeang Interview.” CNN, Cable News Network, 7 July 2007, www.cnn.com/2007/TECH/science/07/16/yeang.qa/.

“Rebuilding Every 20 Years Renders Sanctuaries Eternal -- the Sengu Ceremony at Jingu Shrine in Ise” JFS Japan for Sustainability.” JFS Japan for Sustainability, Aug. 2013, www.japanfs.org/en/news/archives/news_id034293.html.

Sant’Elia, Antonio, “Manifesto of Futurist Architecture,” 1913, reprinted in *Futurist Manifestos*, Umbro Apollonio, ed. (New York: Viking, 1970).

“Sustainable Management of Construction and Demolition Materials.” EPA, Environmental Protection Agency, 9 Feb. 2018, www.epa.gov/smm/sustainable-management-construction-and-demolition-materials.

“The Future of Construction: Mushroom Buildings.” *Interesting Engineering*, 11 Mar. 2018, interestingengineering.com/future-construction-mushroom-buildings.

Yazdi, Mohammad Farid Alvansaz, et al. “Bio-Composite Materials Potential in Enhancing Sustainable Construction.” *Desalination and Water Treatment*, vol. 52, no. 19-21, 2013, pp. 3631–3636., doi:10.1080/19443994.2013.854105.

“Zeitz Museum of Contemporary Art Africa / Heatherwick Studio” 18 Sep 2017. *ArchDaily*. Accessed 14 Mar 2018. <<https://www.archdaily.com/879763/zeitz-museum-of-contemporary-art-africa-heatherwick-studio/>> ISSN 0719-8884