

Examination of the Degradation of the Antineoplastic Drug 5-Fluorouracil by Chlorine at  
Varying Treatment Conditions

Jessica Tanumihardja

A thesis

Submitted in partial fulfillment of the  
requirements for the degree of

Master of Science in Engineering

University of Washington

2013

Committee:

Gregory V. Korshin

Michael C. Dodd

Program Authorized to Offer Degree:

Civil and Environmental Engineering

©Copyright 2013  
Jessica Tanumihardja

University of Washington

**Abstract**

Examination of the Degradation of the Antineoplastic Drug 5-Fluorouracil by Chlorine at  
Varying Treatment Conditions

Jessica Tanumihardja

Chair of the Supervisory Committee:  
Professor Gregory V. Korshin  
Department of Civil and Environmental Engineering

Trace-level organic contaminants that belong to the group of chemotherapeutic (antineoplastic) drugs have been detected in municipal wastewaters and, at lower concentrations, surface waters. The presence of even trace levels of these compounds is of concern due to their inherently high toxicity and low biodegradability. In this study, we examined effects of chlorine concentrations, pH and other reaction conditions such as reaction time, ionic strength, and concentrations of bromide and chloride on the removal of 5-fluorouracil (5-FU). The experimental procedure was primarily based on the spectrophotometric determination of 5-FU concentrations.

The data were processed to obtain pseudo first-order reaction rates of the removal of 5-FU. Apparent rates of 5-FU removal were strongly pH-dependent reaching a maximum at a pH close to 7.3. Variation of bromide and chloride levels resulted in strong changes of pH-dependent apparent kinetic rates. The obtained data allowed estimating half-times of 5-FU in chlorinated

water. For a typical chlorine concentration of 1 mg/L, and in the absence of bromide, 50% of 5-FU can be removed within ca. one hour of exposure at pH close to 7.3. The half time decreases rapidly in the presence of even trace levels of bromide. The obtained results show that water treatment conditions play a critical role in the removal of 5-FU and other trace-level antineoplastic agents that may be present in wastewater and drinking water supplies.

## ACKNOWLEDGEMENTS

I would like to express my greatest gratitude for Prof. Gregory V. Korshin for guidance, patience, knowledge, comments, motivations, and ideas for my thesis and classes throughout my years in Civil and Environmental Engineering (CEE) department at University of Washington (UW). The knowledge and intangible skills imparted would be useful for my future endeavor. I would like to thank my committee member and great teacher Dr. Michael C. Dodd for the guidance, reaction mechanism input, and encouragement. I would also extend my gratitude to all the Professors: Mark Benjamin, Michael Brett, Rebecca Neumann, David Stahl, David Stensel, Qiuming Yu, and Sergey Rabotyagov who have guided and imparted their knowledge to me throughout my study both in CEE and Chemical Engineering. I would like to thank all CEE staffs and lab managers for their help and advices.

I thank my lab partners, Wei Li and Takaaki Masuyama, who worked on similar projects on 5-fluorouracil degradation. They willingly taught and shared the laboratory knowledge and data. I would also like to thank supportive lab mates and classmates for these two challenging yet enjoyable years: Yuan Gao, Sixuan He, Emily Legault, James Liu, Stephanie Wei, Weiqi Wang, UW AWWA-WEF members, and many others.

My sincere thanks also go to King County Wastewater Treatment Division for the incredible internship opportunity. I thank my project managers Erica Jacobs, Michael Popiwny, Sue Hildreth, Butch Harold, Crystal Fleet, Liz Gaskill, and Jane McPherson. I also thank all the engineers Mike Tseng, Mike Clark, John Komorita, Rebecca Gauff, Dionnie Dionisio, and many more for their guidance and help. Special thanks to my Green Innovative Safety Technology, LLC team (Ricky Holm, Hinkei Wong, and Lloyd Passion), for introducing a fun sustainability project and broadening my experience.

I dedicate this thesis for my family: Ing Ie Tanumihardja, Johanna Zakaria, Janice Tanumihardja, Henny Tjhio, Tjong Fon Nyan and my extended families in California, Iowa, Indonesia, and Australia. Their great support physically, mentally, and spiritually is what keeps me reaching my dreams.

People are influenced by their close friends, and I am thankful to have an awesome circle of friends. I would not reach this point without the encouragement, care, and love from all of my family and close friends from UW, IFGF Church, Shoreline Community College, and all over the world. I thank my friends who have always been there for me: Thea Kamadjaja, Nichole Sinarmanto, Kathleen Sinarmanto, Angela Tabukang, Gracia Ruth Immanuel, Herlina Antono, Aryani S. Pratiwi, my Junior High Acceleration classmates, and all the International Care Group team.

Most of all, I would like to express my gratitude to my Lord and Savior, Jesus Christ, for pouring endless love, care, revelations, and guidance throughout my life. I could not have done all of this without him.

# TABLE OF CONTENTS

ACKNOWLEDGEMENTS.....	i
TABLE OF FIGURES .....	iv
TABLE OF TABLES .....	v
1. INTRODUCTION.....	1
1.1 Antineoplastic Drugs and Their Ecotoxicity .....	1
1.2 Chlorine Disinfection History .....	5
1.3 Chlorination Theory .....	6
1.4 Reactions of Pharmaceutical Contaminants .....	12
1.5 Objectives.....	20
2. MATERIALS AND METHODS .....	21
2.1 Standards and Reagents .....	21
2.2 Absorbance Spectra of 5-Fluorouracil and Model Compound .....	21
2.3 Chlorination Reactions.....	24
2.4 Data Characterization and Analysis .....	25
3. RESULTS AND DISCUSSIONS.....	27
3.1 Effects of pH on the Absorbance of 5-fluorouracil .....	27
3.2 Initial Data on the Chlorination of Uracil and 5-FU.....	28
3.3 Calculations of Apparent Reaction Rates.....	31
3.4 Effect of Sodium Chloride Concentrations.....	32
3.5 Reaction Mechanism and Possible Reaction Scheme.....	38
3.6 Reaction Modeling .....	44
3.7 Estimations of half-times of 5-FU in treated water .....	49
4. CONCLUSION.....	51
5. Bibliography .....	54
6. Appendix .....	58
6.1 Supporting Figures .....	58
6.2 Derivation of apparent rate of reaction rate of 5-FU chlorination.....	60

## TABLE OF FIGURES

Figure 1 Structures of nitrogen bases uracil, thymine and cytosine.....	3
Figure 2 Schematic of chlorine and bromine speciation in water, adopted from [21].....	8
Figure 3 Speciation of chlorine in absence of bromide (A) and bromine system with 4 mg/l total active chlorine, 1 mg/l bromide, 150 mg/l chloride, and ionic strength of 0.01M. Adopted from [21] .	10
Figure 4 Halogen species equilibrium in seawater with 0.7 M ionic strength, 0.56 M Cl <sup>-</sup> , and 8.62 x 10 <sup>-4</sup> M Br <sup>-</sup> (A) and log concentration plot of HOCl, OCl <sup>-</sup> , and bromine species (B). Adopted from [21].....	11
Figure 5 A) UV spectra for uracil (solid line) and 5-chlorouracil (dotted line). B) Degradation of uracil in 1 and 42 minute with uracil to free chlorine = 1 : 1 and pH =5. C) Degradation of uracil in 2 and 74 minutes at uracil to free chlorine = 1 : 5 and pH = 5. Adopted from [30].....	13
Figure 6 Dominant products of chlorination of uracil. 5-chlorouracil is dominant at uracil to free chlorine = 1 : 1 (A) and 3,5-dichloriuracil is dominant uracil to free chlorine = 1 : 5 (B). Adopted from [30].....	13
Figure 7 Formation of chloramines and cyanogen chloride upon chlorination of uracil and other nitrogen bases. Adopted from [32].....	15
Figure 8 Electron impact mass spectra for main uracil byproducts: trichloroacetaldehyde and trichloroacetic acid. Adopted from [28].....	16
Figure 9 Apparent second order reaction rate for estrone (E1), ethinylestradiol (EE2), and nonylphenol (NP) in various pH. Adopted from [15].....	17
Figure 10 Second order degradation rate constant for activated sludge and MBR batch experiments of 35 pharmaceuticals. No removal is found at $k_{\text{biol}} < 0.1 \text{ L g}_{\text{ss}}^{-1}\text{d}^{-1}$ , partial removal is found for $0.1 < k_{\text{biol}} < 10 \text{ L g}_{\text{ss}}^{-1}\text{d}^{-1}$ , and more than 90% transformation of parent compound is found for $k_{\text{biol}} > 10 \text{ L g}_{\text{ss}}^{-1}\text{d}^{-1}$ . Adopted from [29].....	19
Figure 11 Formation of by-product of 5-FU photodegradation, adopted from [34].....	20
Figure 12 Standard spectra of uracil (left) at neutral pH with various concentrations from 0.005 – 0.2 mg/l [35] and 0.4 mg/l 5-FU (right) with various pH of 5 – 8.5.....	22
Figure 13 Example of first (A) and second derivatives (B) of the absorbance of 5-FU at pH 7 in 1.74 mg/l Cl <sub>2</sub> , 5-FU:Cl ratio of 1:8, and 0.06M NaCl.....	23
Figure 14 Linear correlation of second derivative of 294nm and 268nm to 5-FU concentration with equation.....	23
Figure 15 Schematic of the experimental set-up used to study chlorination reactions of 5-FU.....	25
Figure 16 Effects of pH on the absorbance of 5-FU standard at wavelengths 294 nm and 268 nm. Background electrolyte 0.01M NaCl.....	27
Figure 17 Uracil (0.2 mg/l) absorbance spectra at pH 7 with 2 mg/l chlorine. Adapted from [35].....	28
Figure 18 Concentration plot (ln (C/C <sub>0</sub> )) of uracil over time at pH 5.5, 7, and 9 with uracil:Cl ratio of 1:18.....	29
Figure 19 Absorbance spectra of 5-FU for pH 7 (A) and 4.5 (B). Concentration of 5-FU and initial chlorine concentration are 0.2 and 2mg/l Cl <sub>2</sub> , respectively. No added NaCl [35].....	30
Figure 20 Changes of logarithms of the normalized concentrations of 5-FU (ln (C/C <sub>0</sub> )) vs. time at varying pHs; 5-FU/Cl <sub>2</sub> ratio 1:18. ....	30

Figure 21 Changes in nominal activity coefficient ( $\gamma$ ) for singly and doubly charge ions as a function of sodium chloride concentration increases.....	33
Figure 22 Changes of absorbance spectra of 5-FU for pH 7 (A) and 4.5 (B) in the presence of 1.74 mg/l $\text{Cl}_2$ . Initial 5-FU/ $\text{Cl}_2$ ratio of 8 and concentration of NaCl 0.06 M. ....	34
Figure 23 Changes of absorbance spectra of 5-FU without quenching for pH 7 in the presence of 1.74 mg/l $\text{Cl}_2$ . Initial 5-FU/ $\text{Cl}_2$ weight ratio of 8 and concentration of NaCl 0.06 M. ....	35
Figure 24 Plots of $(\ln(C/C_0))$ of 5-FU vs. time at various NaCl concentrations at pH 7 and 4.5 with 5-FU: $\text{Cl}_2$ molar ratio of 1:8. The $C/C_0$ value of 0.1 M NaCl at time 20 min is not shown. ....	35
Figure 25 Dependence of $k_{app}$ with NaCl concentration at varying pHs.....	36
Figure 26 Absorbance spectra 5-FU in the presence of 2 mg/l chloramine, pH 7.0 [35] .....	37
Figure 27 HPLC data for the degradation of 5-FU in Lake Washington water. 4 mg/l initial $\text{Cl}_2$ concentration, $\text{Cl}_2$ /5-FU molar ratio of 8, concentration of NaCl 0.01 M.....	38
Figure 28 Speciation diagram of 5-fluorouracil taking into account the other possible pKa at 6.4.....	40
Figure 29 Absorbance spectra of 5-FU in chlorine 1:1 ratio on left at various reaction time. The graph on right is 5-FU: $\text{Cl}_2$ ratio of 1:2 various pHs at 7 minutes of reaction time. ....	41
Figure 30 Proposed reaction pathway for uracil chlorination of Uracil: $\text{HOCl}$ molar ratio of 8:1. Adopted from [28] .....	42
Figure 31 Possible reaction pathway in cytosine chlorination reaction, adopted from [30] .....	43
Figure 32 Suggested scheme of 5-FU chlorination.....	44
Figure 33 Apparent rates of chlorination and model with 2 mg/l $\text{Cl}_2$ and $I = 0.001 \text{ M}$ (A) and bromination with $8.6 \times 10^{-6} \text{ M}$ total bromide and low chlorine concentration (B) of 5-FU at varying pHs.....	46
Figure 34 Comparisons between calculated and experimental apparent kinetic rate of chlorination and bromination .....	47
Figure 35 Apparent kinetic constant for chlorination (A) and bromination (B) of 5-Fluorouracil with various activity by presence of NaCl (A) and KBr (B). The experimental $K_{app}$ is the same as Figure 33. ....	48
Figure 36 Dependence of estimated half-lives of 5FU at varying pHs and bromide concentrations at total chlorine concentration of 1 mg/L and 0.2 mg/l. ....	50

## TABLE OF TABLES

Table 1 5-Fluorouracil structures and properties [14, 6].....	4
Table 2 Reaction of the chlorine and bromine species with their respective equilibrium constants, adopted from [21, 25] .....	9
Table 3 Reaction of the chlorine and bromine species based on $\text{OCl}^-$ and $\text{Br}^-$ reference species with their respective equilibrium constants, adopted from [21, 25, 26].....	9
Table 4 Apparent kinetic rate for chlorination (0.2 ppm 5-FU and 2 mg/l $\text{Cl}_2$ ) and bromination ( $8.56 \mu\text{M}$ KBr in $8.56 \mu\text{M}$ $\text{Cl}_2$ ) of 5-Fluorouracil without NaCl addition [35, 40].....	32
Table 5 Rate Constants for 5-FU Degradation in Chlorination (left) and Bromination (right) found by analytic modeling.....	45

# 1. INTRODUCTION

A wide range of pharmaceuticals have been detected in groundwater and surface water affected by various wastewater effluents [1]. Major sources of these contaminants are associated with human activity, farming, and other industrial-scale agricultural activities. Due to the hydrophilicity and inherent resistance of many pharmaceuticals to biodegradation, they tend to pass unchanged through municipal treatment plants reaching surface waters, as has been documented by extensive prior research [1, 2, 3]. Despite their resistance to biodegradation, some of the pharmaceutical compounds might be degraded or otherwise removed via photodegradation, the sorption on solids produced during sludge treatment, and chemical degradation [4]. This study focuses on the degradation by chlorine of a commonly used antineoplastic drug, 5-fluorouracil.

## 1.1 Antineoplastic Drugs and Their Ecotoxicity

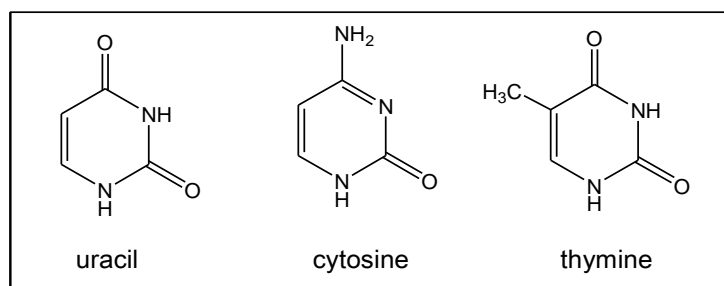
To judge the importance of removing anti-cancer drugs from water sources, the impact of its presence in the environment should be analyzed. As mentioned above, the presence of Pharmaceuticals and Personal Care Products (PPCPs) in wastewater and surface water has been detected in a wide variety of environmental systems and sites. In most cases, concentrations of most of the detected pharmaceuticals are in the range  $\mu\text{g/l}$  to  $\text{ng/l}$  or below [4]. At these levels, they tend to be below the applicable existing drinking water and aquatic life regulations. However, considering the low or essentially non-biodegradability of many of these compounds and their inherent ability to induce biological effects, their presence, even at low concentrations, is a concern because of their ultimately possible toxicity or other effects to the environment and ecological habitats.

Abundant data from numerous studies confirmed the ubiquity and diversity of pharmaceuticals in the environment. In their pioneering study, Kolpin et al. have detected 95 organic compounds in apparently pristine streams and rivers in the U.S. [5]. Other studies have shown the occurrence of antibiotics (e.g., ciprofloxacin, ofloxacin, and metronidazole), anti-inflammatory agents (e.g., acetaminophen and ibuprofen), steroid hormones, and other pharmaceuticals in surface water [1, 6, 7, 8, 9]. Ibuprofen was detected in both sewage treatment plant effluents with maximum concentration of 3.4  $\mu\text{g}/\text{l}$  and river water in Germany [10].

Emerging evidence shows that in addition to many other classes of PPCP, many anti-cancer or antineoplastic agents, for instance 5-fluorouracil (5-FU), cytarabine, and gemcitabine, occur in wastewater effluents and environmental systems affected by them [9, 10]. The last two compounds have some degree of biodegradability but require longer periods of time to fully degrade. In addition to its non-biodegradability, 5-FU is a compound of interest because of its wide use in cancer treatment and its persistence in the environment. The existence of 5-FU in the environment is at a concern due to its effects on the exposed biota as a result of its similar structure to one of the major components of DNA, uracil [6].

Uracil (2,4-deoxy pyrimidine) is one of the nitrogen contained pyrimidine bases of the nucleic acid in ribonucleic acid (RNA). As one of the basic building nucleotide blocks, uracil plays an important role in enzyme synthesis, polysaccharides biosynthesis, and aldehyde sugar transport in the body [11, 12]. Uracil forms a hydrogen bond with adenine to form a base pair in RNA. Deamination of cytosine can cause a mutagenic uracil and guanine mispair to form in DNA [13]. The structure of uracil is exactly the same as that of the 5-fluorouracil structure shown in Table 1, and the only difference between the two compounds is the presence of the

fluorine atom in 5-FU. The structures of uracil and other nitrogen bases such as thymine and cytosine are shown in Figure 1.

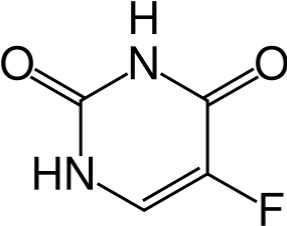


**Figure 1** Structures of nitrogen bases uracil, thymine and cytosine

Due to the similarities of the structures, 5-FU can be mistaken for uracil in RNA replication process but once engaged in this reaction, it interferes with RNA synthesis. Specifically, 5-FU induces irreversible inhibition of thymidylate synthase, with the result that the incorporation of 5-FU in the RNA of cancer cells inhibits the growth of these cells [11]. Due to this effect, 5-FU, like most antineoplastic agents, can also be seen as an endocrine disruptor. The inhibition of cell synthesis makes 5-FU an effective anticancer drug and one that is widely used in the treatment of colorectal, pancreatic, and inflammatory breast cancer [14].

Ecotoxicity assessment of 5-FU showed several effects that depended on its concentration and type of affected organism. Malformation or endpoint growth on fish, amphibians, and crustaceans observed at very low (in terms of laboratory exposures, mg/l) levels of 5-FU and its acute toxicity within 48 hours of test for high, in g/l, 5-FU concentration [6, 15]. The effect was more notable for smaller unicellular organisms such as green algae, cyanobacteria and various other microorganisms for which 5-FU concentrations on the order of  $\mu\text{g/l}$  could result in growth inhibition.

**Table 1** 5-Fluorouracil structures and properties [14, 6]

<b>Name and Structure</b>	 <b>5-Fluoro-2,4(1H,3H)-pyrimidinedione</b>
<b>Formula</b>	C <sub>4</sub> H <sub>3</sub> FN <sub>2</sub> O <sub>2</sub>
<b>Melting Point</b>	283 °C
<b>pKa</b>	8.05 [16]
<b>Solubility</b>	25,900 mg/L in water at 25°C
<b>Human usage</b>	Colorectal, pancreatic, and breast cancer medicine
<b>Actions</b>	Pyrimidine analog, works through irreversible inhibition of thymidylate synthase
<b>Toxicity</b>	Genotoxicity at mg/l, acute toxicity at g/l for fish, amphibians, and crustaceans

The experimental data concerning the actual concentrations of 5-FU in the environment are still limited. A relatively recent review paper “*Combined Environmental Risk Assessment for 5-FU and Capecitabine in Europe*” reported and summarized evaluated 5-FU concentrations in wastewater and surface water in Europe [6]. These evaluations showed that the highest measured 5-FU concentrations were found in wastewater produced by oncological wards and general hospital wastewater at 122 and 2.03 µg/l, respectively [6]. Predicted 5-FU concentrations in the influent of municipal wastewater treatment plants could be as high as 50 µg/l. The concentration of 5-FU recorded in the effluent municipal wastewater averages on a few ng/l, with maximum of 673 ng/l. Concentrations of 5-FU tend to be lower in general municipal sewage and surface water where they tend to be less than 23 ng/l and 1 ng/l, respectively.

It is evident from these data that hospital wastewater contributes in great degree to the loads of these contaminants and hospital effluents are the primary but not the only source of 5-

FU in municipal wastewater and in the environment in general. The concentrations of 5-FU present in municipal wastewater are unlikely to induce significant effects on and functional disruption in microorganisms present in bioreactors of wastewater treatment and exposed to 5-FU concentrations typical for diluted hospital wastewater. Nevertheless, concentrations of 5-FU and other antineoplastic agents may increase due to their expanding use in both inpatient and especially in outpatient applications. In that case, pretreatment of hospital wastewater alone will not be adequate because up to 80% of the chemotherapeutic drugs are delivered outside of hospitals, for instance in private oncology clinics and outpatient treatment situations [17, 18]. In these cases, the introduced antineoplastic drugs that exhibit very little biodegradation pass directly to municipal wastewater or, if released outside the area of municipal wastewater collection, to septic tanks, groundwater, or directly to surface water.

## **1.2 Chlorine Disinfection History**

This study is focused on the effects of chlorine on the rate of degradation and possible degradation mechanism of 5-FU. In this context, it is appropriate to review briefly the history of use of chlorine in water treatment. Such use of chlorine to water treatment was not common if not deemed unacceptable until the first instance of its use in the United States in New Jersey in 1908 [19]. Before that, chlorine was considered too dangerous to be added to water treatment. However, the increasing toll of waterborne diseases, such as typhoid fever, cholera, and diarrhea, consumed the lives of tens of thousands of people in large population centers. This situation pushed scientists and engineers to come up with a solution to this huge problem of public health. Early sewer piping systems were introduced to help reduce the occurrence of waterborne disease. However in some cases, these early piping systems worsened the spread of diseases because of uncontrolled transport of contaminated water that flowed through major cities. As a result, the

death rate from typhoid fever in the US reached as high as 32 people per 100,000 people in 1900 [19].

Dr. Leal and Fuller were the first to prove that the addition of chlorine to large scale water treatment was safe. A decrease in the typhoid death rate was observed immediately after the introduction of water chlorination in Jersey City. Leal and Fuller's research proved that chlorination is the solution to the presence of waterborne diseases in the water supply. Chlorination was put into practice in many U.S. cities from 1909 to 1915. Accordingly, the death rate from typhoid fever decreased dramatically to 1 person per 100,000 people thus bringing waterborne disease epidemics to an end [19]. Despite this and other spectacular successes of water chlorination, waterborne disease is still found in many underdeveloped countries, even in the Western Hemisphere. In 2011, more than 6000 people died because of cholera in Haiti, which mostly due to insufficient water disinfection in that country.

The usage of chlorine for disinfection, however, is not without complications because of the possibility of Disinfection By-product (DBP) formation. The removal or degradation of the target compound such as 5-FU or many other PPCPs might in principle result in stable or unstable by-products with unknown toxicity. In some cases, the by-product possesses higher toxicity than the parent compound. Nevertheless, 75% of the publicly owned treatment works in U.S. are still using chlorine as a disinfectant method [20]. Because of its well-known disinfection ability and relatively low cost, chlorination remains the most practicable and reliable disinfection method worldwide.

### **1.3 Chlorination Theory**

Since chlorination of 5-FU is the main focus of this study, it is appropriate to elaborate more on the relevant chlorination reactions and speciation of chlorine. This theory will form the

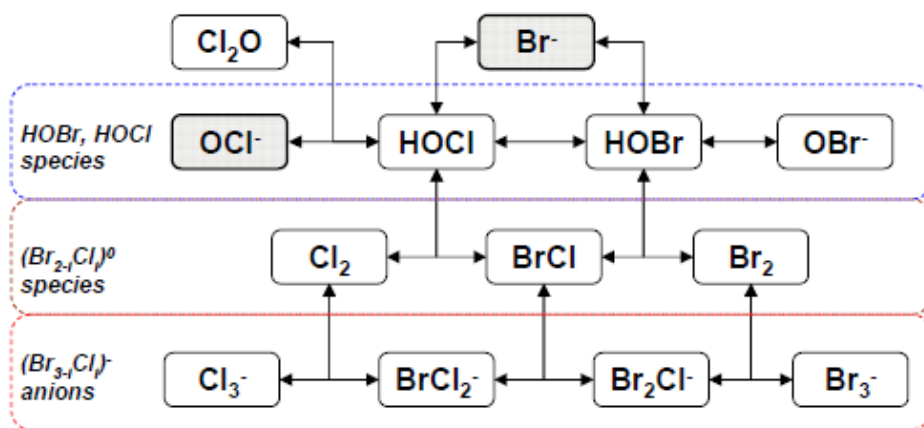
base upon which to analyze the applicable experimental result and carry out necessary modeling. In water disinfection applications, the maximum dose of chlorine is normally up to 4 mg/l Cl<sub>2</sub>. Chlorine can be added to water being treated in the form of sodium hypochlorite (NaOCl), chlorine gas (Cl<sub>2</sub>), calcium hypochloride (Ca(OCl)<sub>2</sub>), and monochloramine (NH<sub>2</sub>Cl) [20]. The last two reagents are less common than concentrated NaOCl form or chlorine gas.

Many aspects of mixed systems containing both chlorine and bromine species have been discussed in prior publications, and a detailed compilation of applicable reactions and their equilibria constants is presented in the a chapter “*Chlorine Based Oxidants for Water Purification and Disinfection*” of the recent book of the American Chemical Society dedicated to redox processes relevant to environmental engineering applications [21]. The speciation, reaction pathways and kinetics of chlorine reactions in drinking water or wastewater are affected by many system parameters; notably by bromide that is easily oxidized to bromine by free chlorine species. Concentration of bromide in surface water is typically between <10 µg/l to somewhat >2 mg/l Br<sup>-</sup> [22, 23]. The concentrations of bromide and chloride in sea water are much higher, 68.9 mg/l (8.62 x 10<sup>-4</sup> M) Br<sup>-</sup> and 0.56 M Cl<sup>-</sup>, respectively [24].

In water treatment applications, the current interest in systems with simultaneously occurring chlorine and bromine species is defined by the fact that these compounds participate readily in reactions with Natural Organic Matter (NOM) and Effluent Organic Matter (EfOM) that yield chlorine and bromine containing DBPs that have been associated with adverse health effects. While these topics are very important, they are outside of the scope of this thesis and it will not be discussed further.

The equilibrium speciation of chlorine is important since each species of chlorine and other halogens may have distinct reaction pathways and reactivity. A scheme presenting major

bromine and chlorine species in aqueous media is shown in Figure 2 that was adopted from [21]. In this scheme, the halogen species are divided into first, second, and third tiers, with the concentration of the species in these tiers having decreasing dominance in typical environmental conditions. Hypohalogenous acids (HOX) and their anions (OX<sup>-</sup>) are the dominant species in most cases of interest for water treatment. The hydrated dihalogen species (Cl<sub>2</sub> and Br<sub>2</sub>) and the mixed BrCl are included in the second dominance tier. Finally, the four trihalogenide ions Cl<sub>3</sub><sup>-</sup>, BrCl<sub>2</sub><sup>-</sup>, Br<sub>2</sub>Cl<sup>-</sup>, and Br<sub>3</sub><sup>-</sup> are in the third tier and they are least likely to be dominant. In the scheme shown in Figure 2, the formation of the chlorine, bromine, and mixed species indirectly involves Cl<sub>2</sub>O but the latter compound is present only hypothetically and practically it does not play any significant role.



**Figure 2** Schematic of chlorine and bromine speciation in water, adopted from [21]

All the species shown in Figure 2 are deemed to reach steady state concentrations nearly instantaneously in water. The nominal formation reactions of these chlorine and bromine species with their respective equilibrium constants are compiled in Table 2 and Table 3, respectively. These data are used for the modeling described in the discussion section of this thesis.

**Table 2** Reaction of the chlorine and bromine species with their respective equilibrium constants, adopted from [21, 25]

Reaction	Equilibrium constant
(T1.1) $HOCl \leftrightarrow OCl^- + H^+$	pK 7.47
(T1.2) $HOBr \leftrightarrow OBr^- + H^+$	pK 8.59
(T1.3) $HOBr + Cl^- \leftrightarrow HOCl + Br^-$	$6.5 \cdot 10^{-6}$
(T1.4) $Cl_2 + H_2O \leftrightarrow HOCl + Cl^- + H^+$	$1.04 \cdot 10^{-3} M^2$
(T1.5) $Br_2 + H_2O \leftrightarrow HOBr + Br^- + H^+$	$6.1 \cdot 10^{-9} M^2$
(T1.6) $BrCl + H_2O \leftrightarrow HOBr + Cl^- + H^+$	$1.3 \cdot 10^{-4} M^2$
(T1.7) $BrCl + H_2O \leftrightarrow HOCl + Br^- + H^+$	$8.7 \cdot 10^{-10} M^2$
(T1.8) $2BrCl \leftrightarrow Cl_2 + Br_2$	$7.6 \cdot 10^{-3}$
(T1.9) $BrCl + Cl^- \leftrightarrow Cl_2 + Br^-$	$9.1 \cdot 10^{-7}$
(T1.10) $Cl_2 + Cl^- \leftrightarrow Cl_3^-$	$0.18 M^{-1}$
(T1.11) $Cl_2 + Br^- \leftrightarrow BrCl_2^-$	$4.2 \cdot 10^6 M^{-1}$
(T1.12) $BrCl + Cl^- \leftrightarrow BrCl_2^-$	$3.8 M^{-1}$
(T1.13) $Br_2 + Cl^- \leftrightarrow Br_2Cl^-$	$1.3 M^{-1}$
(T1.14) $BrCl + Br^- \leftrightarrow Br_2Cl^-$	$1.8 \cdot 10^4 M^{-1}$
(T1.15) $Br_2 + Br^- \leftrightarrow Br_3^-$	$16.1 M^{-1}$

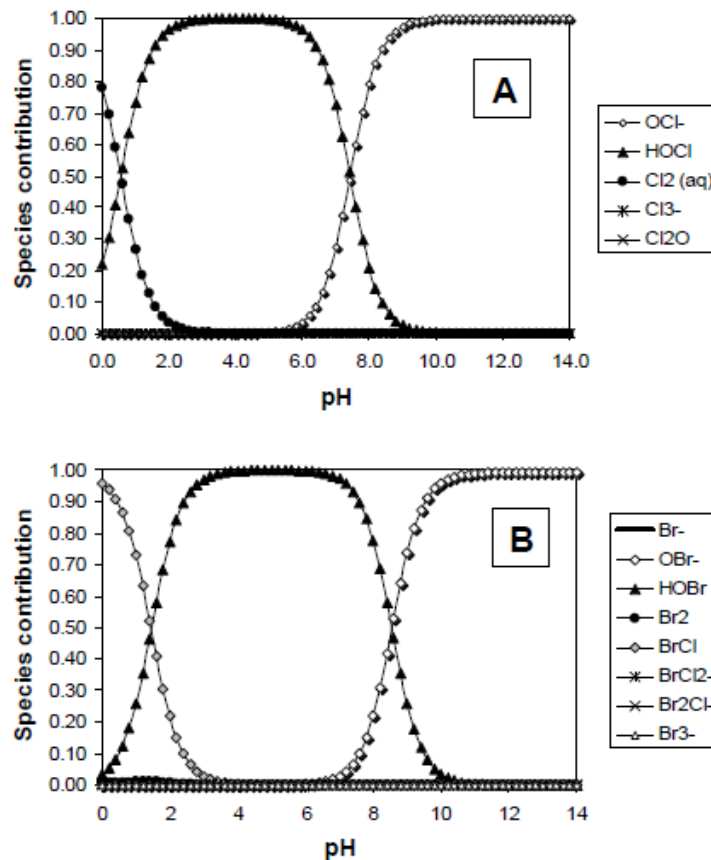
**Table 3** Reaction of the chlorine and bromine species based on  $OCl^-$  and  $Br^-$  reference species with their respective equilibrium constants, adopted from [21, 25, 26]

Species	Formal reaction stoichiometry	LogK <sub>i</sub>
<i>HOCl</i>	(T2.1) $OCl^- + H^+ \leftrightarrow HOCl$	7.47
<i>Cl<sub>2</sub></i>	(T2.2) $OCl^- + Cl^- + 2H^+ \leftrightarrow Cl_2 + H_2O$	10.5
<i>Cl<sub>3</sub><sup>-</sup></i>	(T2.3) $OCl^- + 2Cl^- + 2H^+ \leftrightarrow Cl_3^- + H_2O$	9.7
<i>Cl<sub>2</sub>O</i>	(T2.4) $2OCl^- + 2H^+ \leftrightarrow Cl_2O + H_2O$	12.9
<i>OBr<sup>-</sup></i>	(T2.5) $OCl^- + Br^- \leftrightarrow OBr^- + Cl^-$	4.1
<i>HOBr</i>	(T2.6) $OCl^- + Br^- + H^+ \leftrightarrow HOBr + Cl^-$	12.7
<i>Br<sub>2</sub></i>	(T2.7) $OCl^- + 2Br^- + 2H^+ \leftrightarrow Br_2 + H_2O + Cl^-$	20.9
<i>BrCl</i>	(T2.8) $Br^- + OCl^- + 2H^+ \leftrightarrow BrCl + H_2O$	16.5
<i>BrCl<sub>2</sub><sup>-</sup></i>	(T2.9) $OCl^- + Cl^- + Br^- + 2H^+ \leftrightarrow BrCl_2^- + H_2O$	16.3
<i>Br<sub>2</sub>Cl<sup>-</sup></i>	(T2.10) $OCl^- + 2Br^- + 2H^+ \leftrightarrow Br_2Cl^- + 2H_2O$	21.0
<i>Br<sub>3</sub><sup>-</sup></i>	(T2.11) $OCl^- + 3Br^- + 2H^+ \leftrightarrow Br_3^- + Cl^- + H_2O$	22.1

At low ionic strengths, halogen species in surface waters are dominated by the first tier compounds whose contributions are also affected by the concentration of chloride and bromide

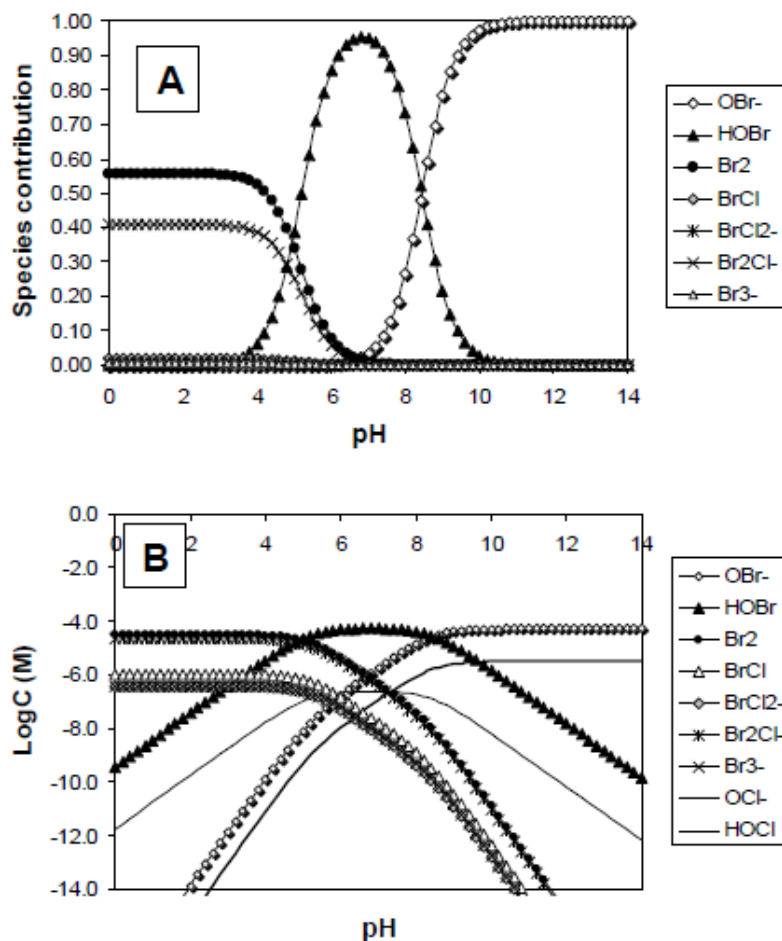
ions and, more prominently, by pH values. This effect is shown in Figure 3 demonstrating that in the absence of bromide, HOCl is dominant at pH lower than 7.4 while OCl<sup>-</sup> is dominant at pH greater than 7.6 [21]. The removal of bacteria, virus, and some protozoa are higher at lower pH because HOCl germicidal efficiency is 40 – 80 times higher than OCl<sup>-</sup> [27].

When bromide is present, a number of bromine-containing and mixed species is formed. Their contributions at varying pH levels in typical conditions, for instance, for a 1 mg/L concentration of bromide and 4 mg/L chlorine are shown in Figure 3B. In these conditions, HOBr is dominant at pH < 8.4 and OBr<sup>-</sup> is dominant at pH > 8.7. BrCl is dominant at pH < 3.5.



**Figure 3** Speciation of chlorine in absence of bromide (A) and bromine system with 4 mg/l total active chlorine, 1 mg/l bromide, 150 mg/l chloride, and ionic strength of 0.01M. Adopted from [21]

The speciation of halogen in seawater was not directly addressed in this study but it is worth examining some of its features. As mentioned above, seawater contains much higher chloride and bromide concentrations than surface water and its ionic strength is 0.7 M. The equilibrium speciation of chlorine and bromine in these conditions calculated using MINEQL+ software is shown in Figure 4. Hydrated bromine is the dominant species at  $\text{pH} < 5$  while HOBr is dominant at  $5 < \text{pH} < 8$  and OBr<sup>-</sup> is dominant at  $\text{pH} > 8.6$  when OCl<sup>-</sup> present. The oxidative power of halogen species (that is, the redox potential expected in their presence) tends to be lower in seawater compare to typical surface waters [21].



**Figure 4** Halogen species equilibrium in seawater with 0.7 M ionic strength, 0.56 M Cl<sup>-</sup>, and  $8.62 \times 10^{-4}$  M Br<sup>-</sup> (A) and log concentration plot of HOCl, OCl<sup>-</sup>, and bromine species (B). Adopted from [21]

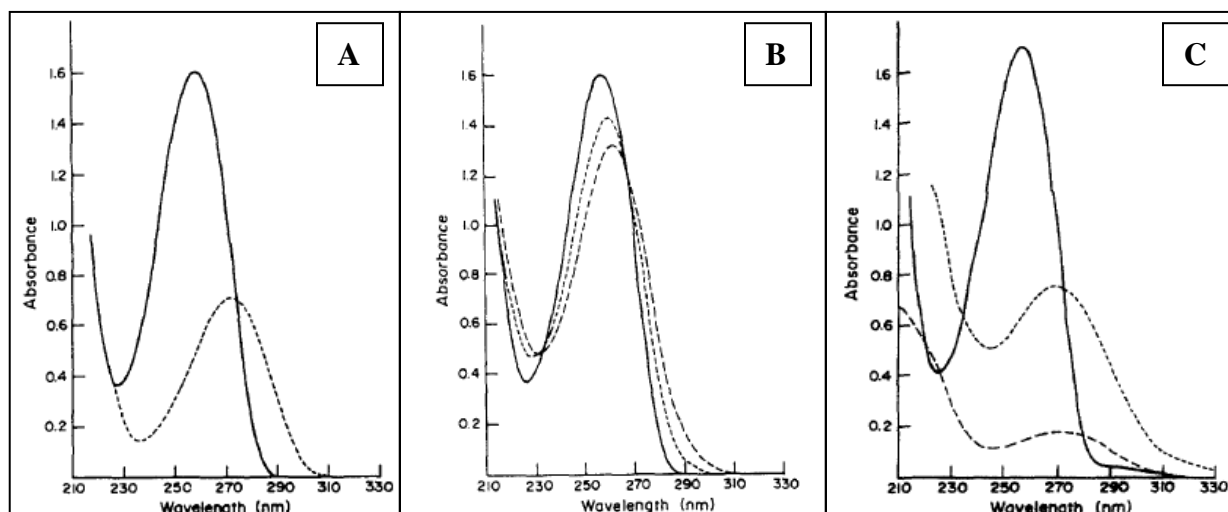
## 1.4 Reactions of Pharmaceutical Contaminants

Considerable effort has been invested in the characterization of the degradation of biologically active organic compounds, especially pharmaceuticals, by various oxidants [28, 29, 30]. Since this study is focused on reactions of 5-FU that is structurally very close to uracil, it is important to mention that Gould et al. investigated kinetics and products of reactions of uracil with HOCl in water [30]. The reaction was determined to follow second order kinetics at low ( $\leq 1.0$ ) free chlorine to uracil ratios. A similar pattern was determined to be the case of the chlorination of caffeine whose structure has a dinitrogen cycle similar to that of uracil [31]. At high ratios of chlorine to the substrate, the reaction initially followed second order kinetics but its complexity increased after molar ratio  $\geq 5$ . The UV spectra for low and high initial reactant ratios of chlorine to uracil are shown in Figure 5.

At low free chlorine to uracil ratio, the main product of uracil chlorination deduced from the examination of the UV spectra of reaction mixture was 5-chlorouracil formed via the reaction of one mole uracil with one mole of free chlorine. No noticeable degradation of 5-chlorouracil was observed in these conditions. At relatively high free chlorine to uracil ratio of 5, 5-chlorouracil was formed but only during the initial phase of the reaction. Then, 5-chlorouracil was degraded within ca. 75 minutes. More free chlorine was observed to be consumed at high  $\text{Cl}_2$ /uracil ratio and one mole of uracil consumed nearly two moles of free chlorine.

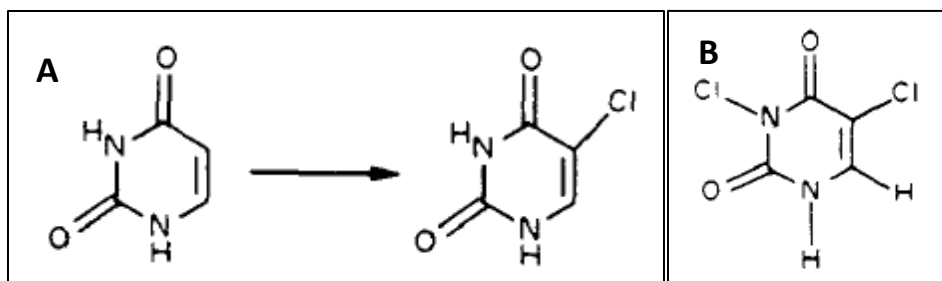
The reaction products formed upon the chlorination of uracil were examined using chromatography, UV spectra, mass spectrophotometry, and Nuclear Magnetic Resonance (NMR) spectrometry. The methods showed that no stable chloramines and no other monochlorinated chlorouracils (other than 5-chlorouracil mentioned above) formed at high  $\text{Cl}_2$ /uracil ratios. However, instead of 5-chlorouracil, 3,5-dichlorouracil was the dominant product at these

conditions as shown in Figure 6. The rate of degradation of uracil by chlorine was pH dependent for both low and high reactants ratio.



**Figure 5** A) UV spectra for uracil (solid line) and 5-chlorouracil (dotted line). B) Degradation of uracil in 1 and 42 minute with uracil to free chlorine = 1 : 1 and pH=5. C) Degradation of uracil in 2 and 74 minutes at uracil to free chlorine = 1 : 5 and pH=5. Adopted from [30]

Reactions of uracil with chlorine can be compared with those of other nitrogen bases that have a similar structure. Prior studies concerned with the reaction of these compounds were carried mostly to examine the formation of DBPs from purine and pyrimidines in the presence of chlorine and compared the results with those obtained for NOM or humic substances [28]. In the latter study, chlorination of uracil and thymine was carried out at pH 7 and up to 24 hour reaction time.

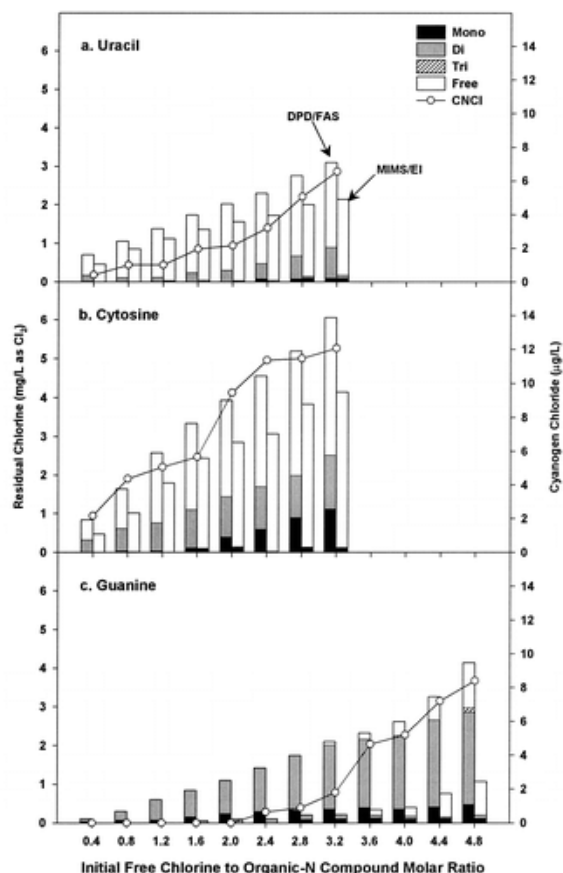


**Figure 6** Dominant products of chlorination of uracil. 5-chlorouracil is dominant at uracil to free chlorine = 1 : 1 (A) and 3,5-dichlorouracil is dominant uracil to free chlorine = 1 : 5 (B). Adopted from [30]

When high chlorine concentrations were used, trichloroacetic acid containing the carbon atoms initially found in the 5<sup>th</sup> and 6<sup>th</sup> positions of the heterocyclic ring of the nitrogen bases was generated as the main product. Electron impact mass spectra of uracil main byproducts are shown in Figure 8. Chloral hydrate (trichloroacetaldehyde) was also detected as the main volatile product of uracil. This finding confirms the 5-chlorouracil main product discussed by Gould et al. in preceding section [30].

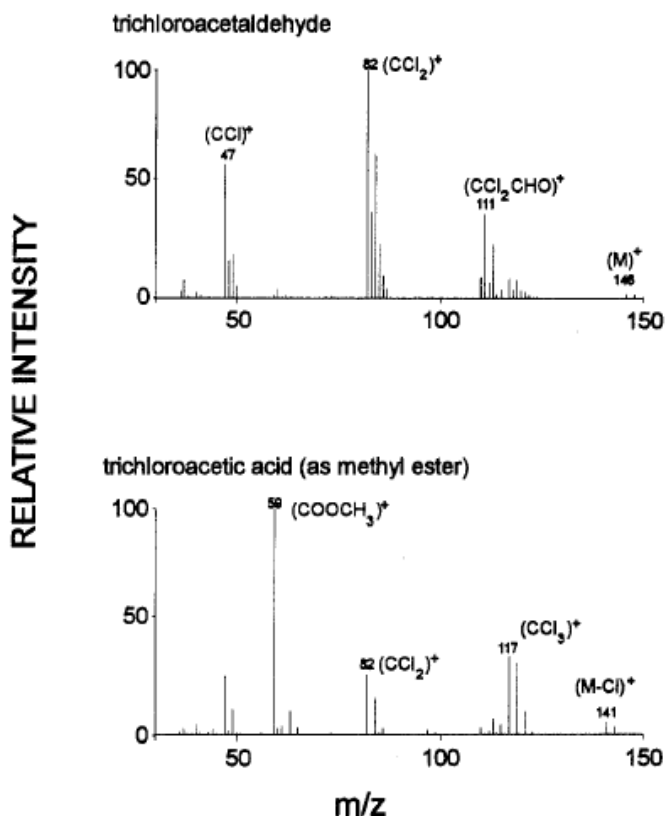
Chloral hydrate (trichloroacetaldehyde) was also detected as the main volatile product of uracil reactions with chlorine. Chloral hydrate is a common DBP formed in chlorine disinfected drinking water and its concentrations can be 10 µg/ l or higher [28]. At 30:1 chlorine to uracil ratio, chloral hydrate was the main product of the chlorination reactions. Halo-aldehydes, especially chloral hydrate, product increases in water with higher NOM or nitrogen constituent compounds.

Other products of the chlorination of uracil, notably the formation of highly toxic dichloroacetonitriles and cyanogen chloride, as well as chloroform were detected in a later study by Shang et al. 2000 [32]. This study also showed that free chlorine added to the system existed mostly as free chlorine but some formation of di- and monochloramines was detected, especially for molar chlorine/uracil (or related compounds) ratios > 1.5 to 2 (Figure 7).



**Figure 7** Formation of chloramines and cyanogen chloride upon chlorination of uracil and other nitrogen bases. Adopted from [32]

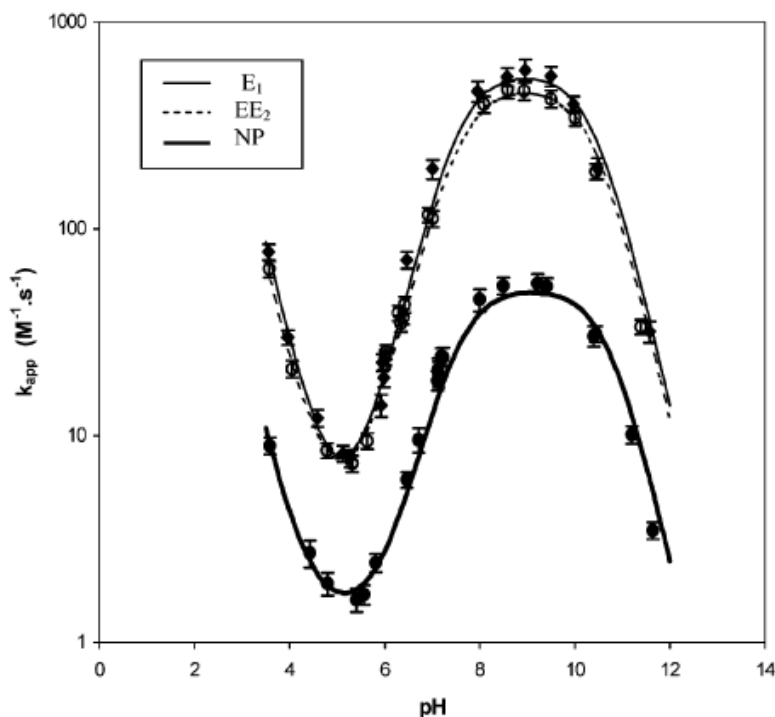
Because 5-FU is similar to uracil in structure, it is both toxic and it can also exert endocrine disruption. Because of this, 5-FU can be included in the group of endocrine disruptor compounds (EDCs). Chlorination of many such compounds, notably those of steroid hormones has been examined in prior research. Deborne et al. 2004 examined the chlorination kinetics of natural steroid hormones ( $\beta$ -estradiol, estrone, estriol, progesterone), synthetic hormones (17 $\alpha$ -ethinylestradiol), and other commonly occurring EDCs (4-n-nonylphenol) [15]. All these EDCs have a phenolic ring (except progesterone), all the hormones also have a cyclopentan-o-perhydrophenatherene ring.



**Figure 8** Electron impact mass spectra for main uracil byproducts: trichloroacetaldehyde and trichloroacetic acid. Adopted from [28]

Chlorination of these compounds was examined at the room temperature in the range of pH 3.5 to 12. Kinetically, these reactions followed a second order pattern and the apparent rates were pH-dependent. The apparent rate of reaction increases with increasing chlorine reactant concentration. The maximum reaction rate was observed for  $8 < \text{pH} < 10$  as shown in Figure 9 [15]. This was interpreted to be caused by changes of the speciation of the examined steroid hormones. Ionized forms of their molecules are the dominant species in  $\text{pH} > 7$ , and they were deemed more reactive towards HOCl while  $\text{OCl}^-$  was much less active in chlorination. In a  $4 < \text{pH} < 6$  range, the neutral form of these species was dominant and oxidized mostly by  $\text{H}_2\text{OCl}^+$  that was hypothesized to be the main oxidation-active form of chlorine at low pHs. The result shown in Figure 9 will be compared with those generated in this study in the discussion section.

Natural and synthetic hormones have a relatively high reactivity towards chlorine and accordingly, their half-lives may be low in wastewater or drinking water chlorination conditions. For instance, estrone was predicted to have a 6.3 minutes half-life in the presence of 1 mg/l chlorine concentration while 4-n-nonylphenol was predicted to have a 65 minute half-life. The fact that the phenolic ring was important for chlorination of the examined EDC was confirmed by the observation that little or no degradation was observed for progesterone. Chlorine substitution into the molecules of the steroid hormones was suggested to result in the formation of 2-monochloro-ED and 2,6-dichloro products of the initial compounds.

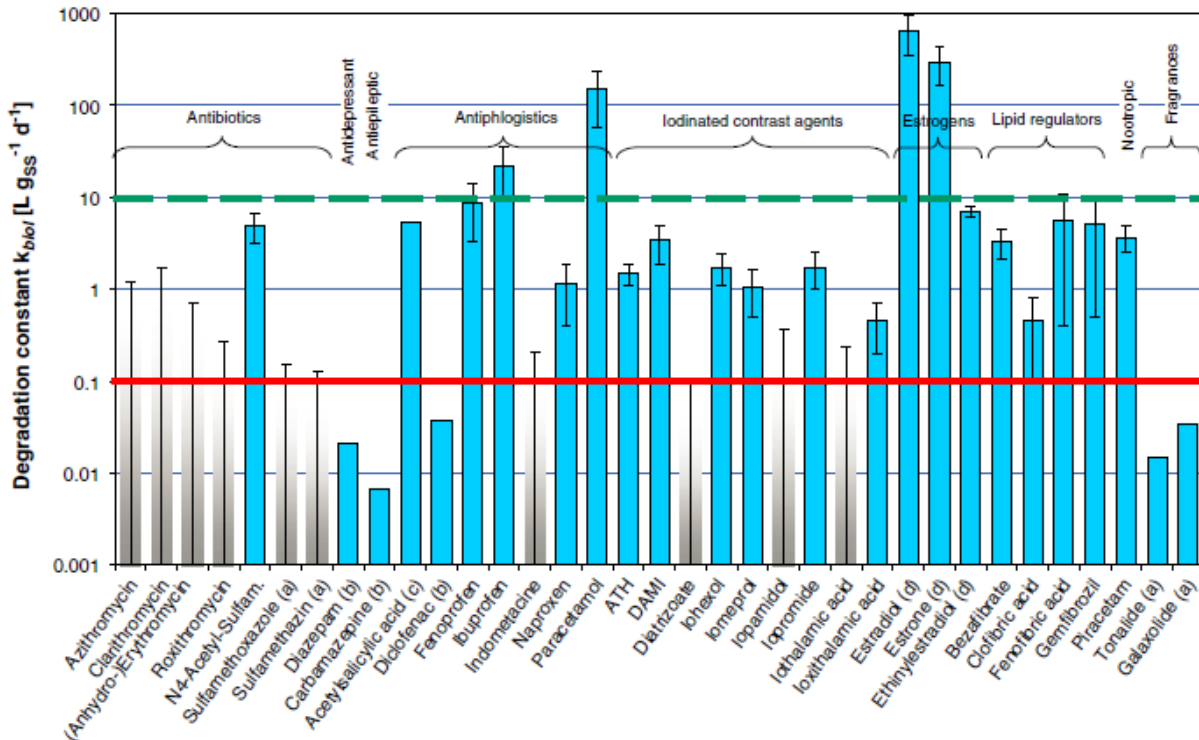


**Figure 9** Apparent second order reaction rate for estrone (E1), ethinylestradiol (EE2), and nonylphenol (NP) in various pH. Adopted from [15]

The obtained kinetic data allowed determining EDCs removal efficiencies in conditions of wastewater chlorination. The removal efficiency of the estrogens and nonylphenol, a widely occurring non-hormonal EDC, in the circumneutral pH range, 2 mg/l chlorine, and 15 min contact time were estimated at 95% and 27 %, respectively [15]. Thus, reactions of these and

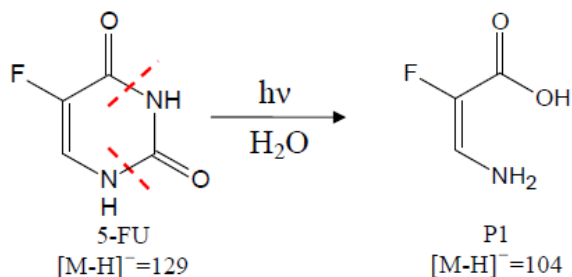
other EDCs with chlorine are also important as biological process in wastewater treatment using Activated Sludge and Membrane Biological Reactor (MBR) tend to degrade or transform only 4 out of 35 typically occurring pharmaceuticals [29]. Most of antibiotics, antiphlogistics, contrast agents, lipid regulators, and nootropic compounds are persistent in biological wastewater treatment.

The biological degradation of pharmaceuticals tends to follow a pseudo first order reaction kinetics. As shown in Figure 10, the average apparent degradation constants of many EDC/PPCPs by activated sludge and MBR processes are between  $0.1 - 10 \text{ L g}_{\text{ss}}^{-1} \text{d}^{-1}$ ; this results are partial removal only [29]. Ibuprofen, paracetamol, estradiol, and estrone were mostly transformed as the degradation rates are above  $10 \text{ L g}_{\text{ss}}^{-1} \text{d}^{-1}$ . Estrone and estriol removal in wastewater were reported above 60% in another experiment [33]. However, the tremendous diversity of microbial populations and their activities in degrading EDC/PPCPs increases the complexity of predicting the corresponding degradation rates and their applicability to a sufficiently wide range of wastewater properties (e.g., it has been found that lower degradation rate are typical for diluted wastewaters). Thus, microbiological treatments of wastewater as well as other processes causing the degradation of trace-level PPCP/EDCs in wastewater are more optimal when carried out at the treatment plants.



**Figure 10** Second order degradation rate constant for activated sludge and MBR batch experiments of 35 pharmaceuticals. No removal is found at  $k_{biol} < 0.1 L g_{ss}^{-1} d^{-1}$ , partial removal is found for  $0.1 < k_{biol} < 10 L g_{ss}^{-1} d^{-1}$ , and more than 90% transformation of parent compound is found for  $k_{biol} > 10 L g_{ss}^{-1} d^{-1}$ . Adopted from [29]

A recent study reported that while 5-FU resist to biodegradation, it can be photo-degraded within hours when nitrate and bicarbonate ions presence in the water [34]. At a 2 mg/l nitrate concentration and a 2 mM bicarbonate ATN concentration, the half-life of 5-FU in system affected by photodegradation was estimated to be at 8 hours. In the absence of nitrate and bicarbonate, 5-FU half-life increased to  $56 \pm 11$  hours as was determined for 38 nM – 77  $\mu M$  initial concentration of 5-FU. It was predicted that the major by-product of 5-FU photodegradation is formed by cleavage of 5-FU ring as shown in Figure 11. Thus, 5-FU could possibly be degraded below its toxic level when sunlight is present. The toxicity of the by-product of 5-FU degradation by halogenations and photodegradation is not yet known.



**Figure 11** Formation of by-product of 5-FU photodegradation, adopted from [34]

## 1.5 Objectives

As the usage of 5-FU and other chemotherapeutic drugs is steadily increasing worldwide, removal and/or deactivation of these emerging contaminants during water treatment is essential. While 5-FU has been found to be readily degradable by ozone at sufficient high doses of that powerful oxidant (e.g., > 2 mg/l in Seattle wastewater), the issue of removal of 5-FU and other antineoplastic drugs by chlorine also needs to be explored in detail due to the much wide use of chlorine, compared to ozone, in drinking water and wastewater operations [35, 20]. In accord with this goal, this study was particularly concerned with the examination of effects of chlorine concentrations, pH, and other reaction conditions such as reaction time, ionic strength, concentration of bromide and chloride on the degradation of 5-FU.

The ultimate goal of these experiments and related modeling was to establish a mechanistic description of the system that would allow rate determination of 5-FU degradation by chlorine with and without bromine in a wide range of conditions. The chlorination of 5-FU in surface water and secondary wastewater effluent were also examined in some extent.

## 2. MATERIALS AND METHODS

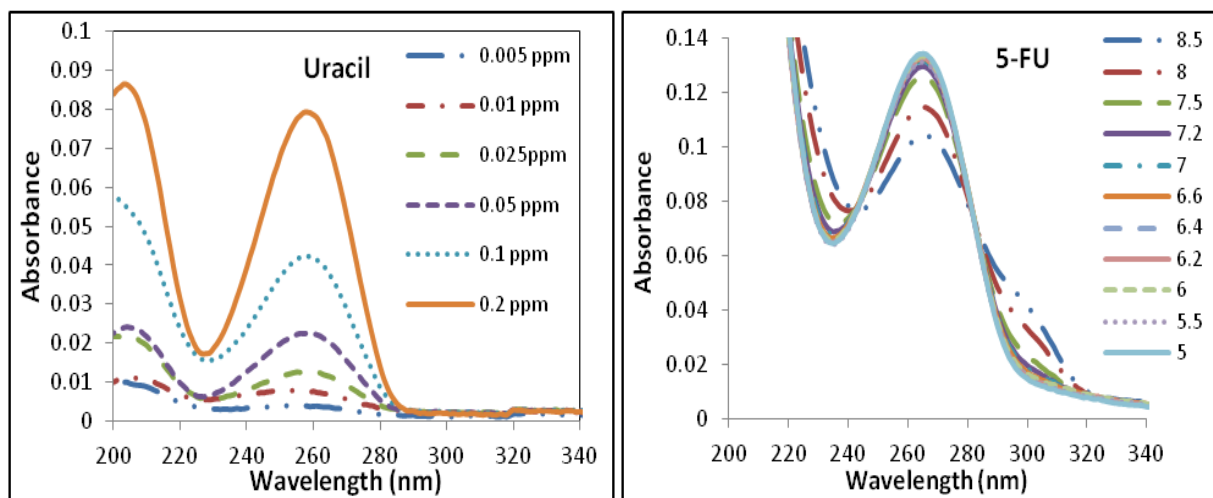
### 2.1 Standards and Reagents

All of the reagents used in the experiments were of analytical grade. They were used without further purification. Solutions were made fresh before experiment using Milli-Q (Millipore) water periodically. Uracil and 5-FU in powder form with >99% purity were purchased from Sigma Aldrich along with sodium chloride (NaCl) powder. Sodium hypochloride (NaOCl) solution with 5% available chlorine for the chlorine source was obtained from J.T. Baker. Potassium bromide (KBr), sodium sulfite anhydrous (Na<sub>2</sub>SO<sub>3</sub>), and sodium hydroxide (NaOH) were purchased from Fisher Scientific. Hydrochloric acid (HCl) was purchased from J.T. Baker with 36.5 – 38% content. Sodium phosphate monobasic dihydrate and sodium phosphate dibasic anhydrous were used as buffers and purchased from J.T. Baker and Mallinckrodt, respectively. Formic acid 98% was purchased from Fluka Analytical. HPLC grade acetonitrile and methanol were purchased from EMD and Sigma Aldrich. DPD free chlorine reagent for total chlorine measurement was purchased from HACH.

### 2.2 Absorbance Spectra of 5-Fluorouracil and Model Compound

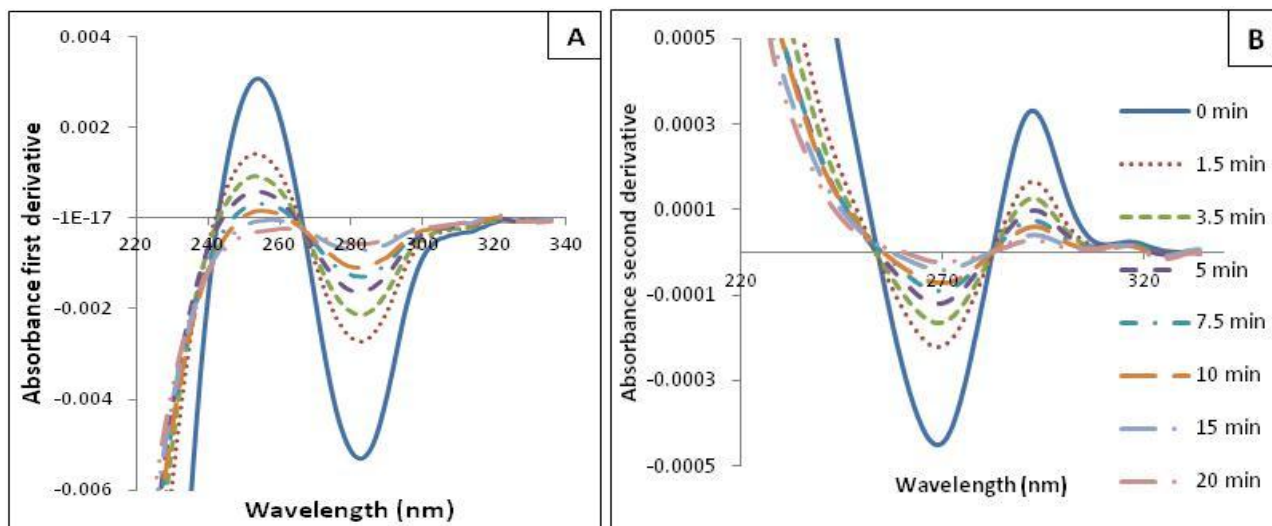
A large part of experiments described below was carried out using absorbance spectroscopy. Accordingly, it is relevant to show the spectra of 5-FU and model compounds in this section. The absorbance spectra of dissolved uracil and 5-FU at various pH in the absence of chlorine were measured to quantify their intensity and location of the important features. Spectra of 5-FU solution from 0.05-0.5 mg/l were also measured to generate a standard curve. The absorbance spectra of uracil and 5-FU are shown in Figure 12. They are very close to those published in prior research [30] and demonstrate a consistent linear response to changes of

concentrations of 5-FU and uracil as well as predictable changes of the absorbance of 5-FU at varying pHs.



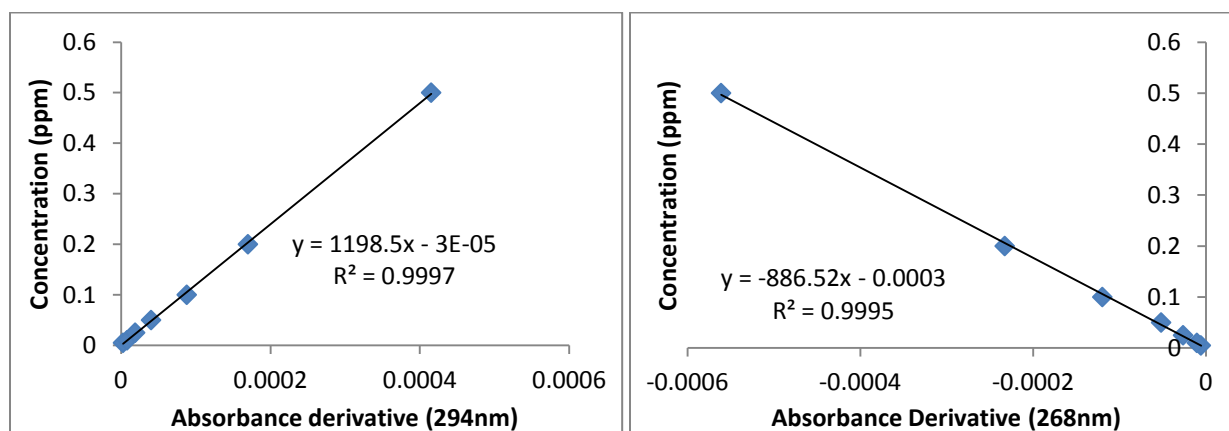
**Figure 12** Standard spectra of uracil (left) at neutral pH with various concentrations from 0.005 – 0.2 mg/l [35] and 0.4 mg/l 5-FU (right) with various pH of 5 – 8.5

First and second derivative of absorbance spectra of 5-FU were also examined and utilized that consumption of 5-FU in halogenation. This type of numerical processing (derivatization) was used to reduce the background non-specific contributions to the absorbance and increase the strengths of relevant correlation. Examples of the calculations of the first and second derivative of the absorbance curve are shown in Figure 13.



**Figure 13** Example of first (A) and second derivatives (B) of the absorbance of 5-FU at pH 7 in 1.74 mg/l  $\text{Cl}_2$ , 5-FU:Cl ratio of 1:8, and 0.06M NaCl

The second order derivative spectra shown above had sharp characteristic peaks located at 268 nm and 290 nm. Because the intensities of these peaks correlated strongly with standard 5-FU spectra, they were used to obtain concentration of 5-FU at given reaction conditions using regression equation shown in Figure 14.



**Figure 14** Linear correlation of second derivative of 294nm and 268nm to 5-FU concentration with equation

At higher pHs, 282 nm and 303 nm wavelength were used for the correlations similar to those shown in Figure 14 as the absorbance spectra of 5-FU changes due to the dominance of its deprotonated species. Wavelength of 258 nm and 290 nm were also used for uracil degradation

calculation. In the analysis of applicable kinetic phenomena, the average concentrations calculated the values of derivatives of the absorbance spectra at these wavelengths to determine the concentration of 5-FU or uracil and calculate the slopes of  $\ln(C/C_0)$  vs. time correlations which were used to determine the apparent rates of reactions. The apparent rates were then interpreted to determine intrinsic rates of reactions between different species of 5-FU and, on the other hand, important species of chlorine and bromine as elaborated in the results and discussion section.

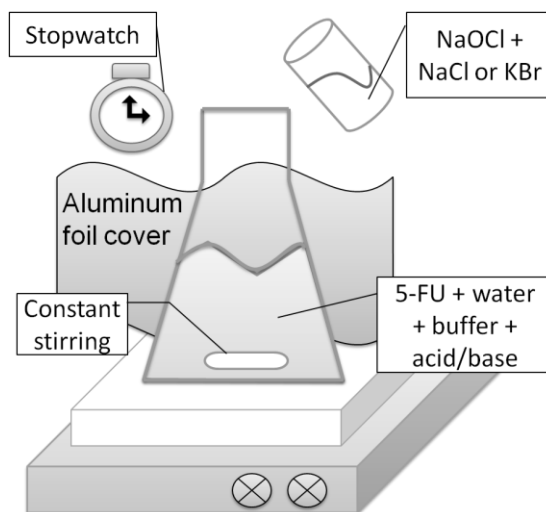
### 2.3 Chlorination Reactions

Reactions of 5-FU with chlorine were examined using a flask covered with aluminum foil as shown in Figure 15. Limited experiments on the chlorination of uracil were also performed to compare their result with the data of prior literature [30]. Experiments were conducted at 5-FU:Cl molar ratios of 1:1, 1:2, 1:3, 1:8, and 1:18. In this report, the molar ratio for all of the calculation and graphs are 1:8, unless noted otherwise, to provide excess but low enough chlorine to see the degradation trend of 5-FU.

Chlorine stock solution concentration was measured before each experiment using HACH DR/4000 spectrophotometer. 5-FU was dissolved in Milli-Q water and mixed with phosphate buffer and its pH was adjusted to a desired pH value using Thermo Scientific pH meter calibrated using standard pH 4, 7 and/or 10 buffers. The solution was constantly stirred throughout the process using Thermolyne stir bar at medium speed.

After the 5-FU solution stabilized, sodium chloride (or if necessary KBr) at various concentrations (0 – 0.1 M) was added to the solution. For bromination reaction, 0 – 100  $\mu$ M of KBr was added. Following this, an aliquote of chlorine stock solution was added to reach a desired  $\text{Cl}_2$  concentration. This time corresponded to time zero of the reaction. Samples of

reaction mixture were withdrawn from the reactor at desired reaction times and quenched immediately with excess  $\text{Na}_2\text{SO}_3$  to stop further reactions [20].



**Figure 15** Schematic of the experimental set-up used to study chlorination reactions of 5-FU

## 2.4 Data Characterization and Analysis

The quenched samples were characterized spectrophotometrically over 200-600 nm wavelength in Perkin Elmer UV/VIS Lambda 18 spectrometer. Two 5 cm quartz cells were used to obtain the UV measurement. First and second derivative of the absorbance with respect to wavelength were calculated to generate sharper peaks that were mostly observed at 268 nm and 294 nm. The applicable regression equations (e.g., those shown in Figure 14) were used to obtain average 5-FU concentrations of 294 nm and 268 nm second derivative of the absorbance. Further data modeling, optimization and interpretation were carried out to determine intrinsic rates of reactions.

Limited experiments to determine the degradation of 5-FU in surface water (filtered Lake Washington water) were done in the same manner described above. The concentration of 5-FU in this system was examined using UV spectrophotometry and High Pressure Liquid

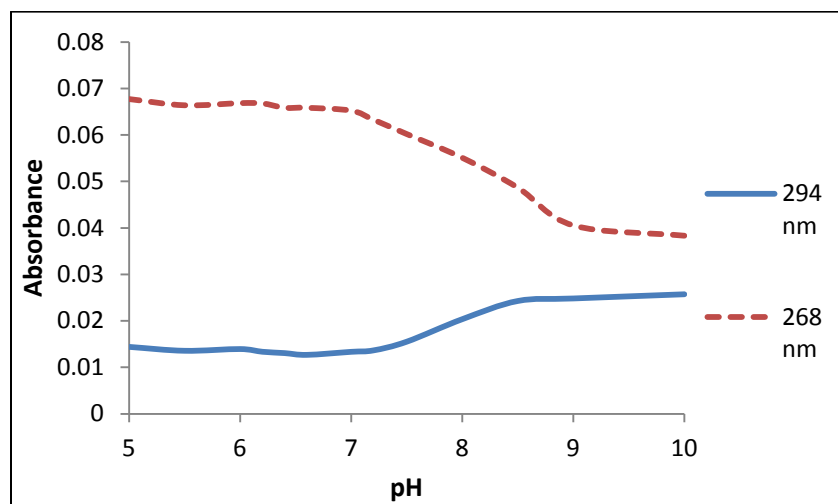
Chromatography (HPLC). HPLC was conducted using Ultimate 3000 Dionex HPLC/IC instrument equipped with an Inertsil ODS-3 C18 Column (150x2.0mm, 0.5 $\mu$ m). Peak separation was done with 0.1% formic acid (A) and 1:1 methanol-acetonitrile (B) eluent. The pump flow for eluent is adjusted as follows: 2% of B for 2 min, linear rise to 90% B within 17 min, isocratic up to 20 min, back to initial condition within 22.1 min, and re-equilibration step up to 30 min [36]. The flow rate of the sample is 0.2 ml/min. The absorbance data at chosen wavelength was plotted against time to evaluate the result.

### 3. RESULTS AND DISCUSSIONS

#### 3.1 Effects of pH on the Absorbance of 5-fluorouracil

Variations of pH had a strong effect on 5-FU absorbance spectra due to the changes of its speciation, in accord with its nominal pK of 8.05. Changes of the entire spectra of 5-FU are shown in Figure 12 while changes of the absorbance of 5-FU at fixed wavelengths corresponding to the maximum absorbance band of 5-FU and its shoulder that develops at pH > 7 are presented in Figure 16. The absorbance at 268 nm decreases gradually at pH > 7 and becomes stable at pH > 9, while while that at 294 nm exhibits an opposite trend.

This is clearly in agreement with the expectation that in the absence of chlorine the protonated and deprotonated forms of 5-FU dominate at pHs < 7 and > 9, respectively, while the gradual changes of the speciation of 5-FU occurs in the pH range 7 to 9.

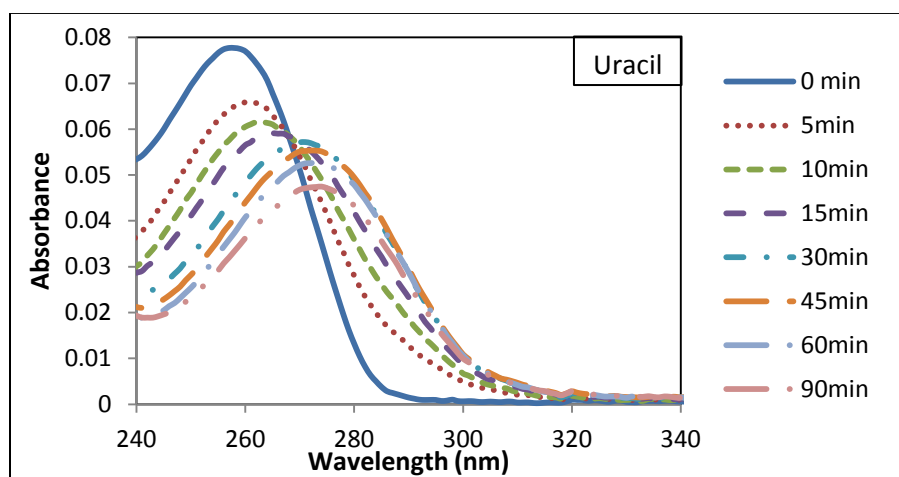


**Figure 16** Effects of pH on the absorbance of 5-FU standard at wavelengths 294 nm and 268 nm. Background electrolyte 0.01M NaCl.

### 3.2 Initial Data on the Chlorination of Uracil and 5-FU

The degradation of 5-FU and the model compound uracil in the presence of chlorine were measured at varying pHs. These reactions were accompanied by consistent changes of absorbance spectra of 5-FU and uracil. The data for uracil at pH 7 are shown in

Figure 17. For clarity, the range of wavelengths in this figure is limited to 240 – 340 nm. The characteristic bands of uracil and 5-FU are located in this region of wavelengths. The data show that the band of uracil (its peak prior to chlorination is located at 258 nm) becomes less intense as the reaction progresses and its maximum shifts gradually to 273 nm. These results support the notion of the formation of 5-chlorouracil, as was discussed in prior literature and illustrated in Figure 5C but the data may also indicate the presence of more complex reaction pathways [30].

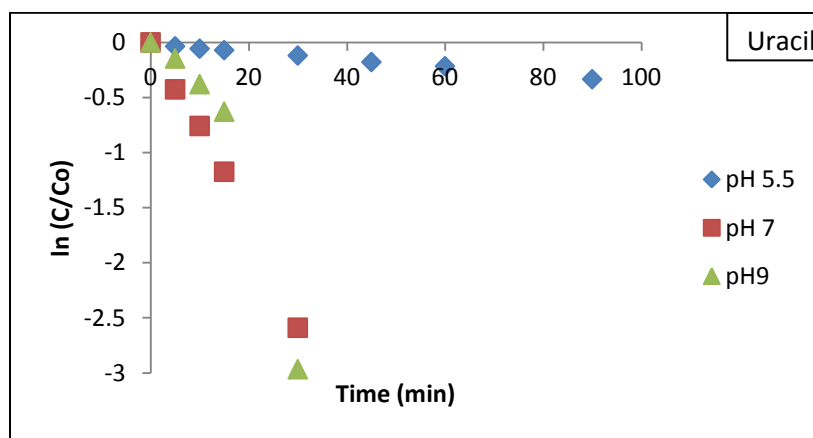


**Figure 17** Uracil (0.2 mg/l) absorbance spectra at pH 7 with 2 mg/l chlorine. Adapted from [35]

For instance, the shift of the absorbance band of uracil to higher wavelengths may indicate a higher acidity of its chlorination product since the deprotonated form of uracil may have spectroscopic properties similar to that of the deprotonated form of 5-fluorouracil in which case a shift to higher wavelengths takes place [30]. Because the nominal pK constant of uracil is

quite high (pK 9.4) and formation of deprotonated forms of uracil is possible only at pH>9, the observed shift of the absorbance band of uracil to higher wavelengths (or a bathochromic shift) can be explained assuming that the pK of chlorine-substituted uracil is much lower than that of the initial compound [37]. While its value for uracil was not examined in this study, the occurrence of the decrease of pK of 5-FU due to addition/substitution of chlorine was observed and quantified in our experiments.

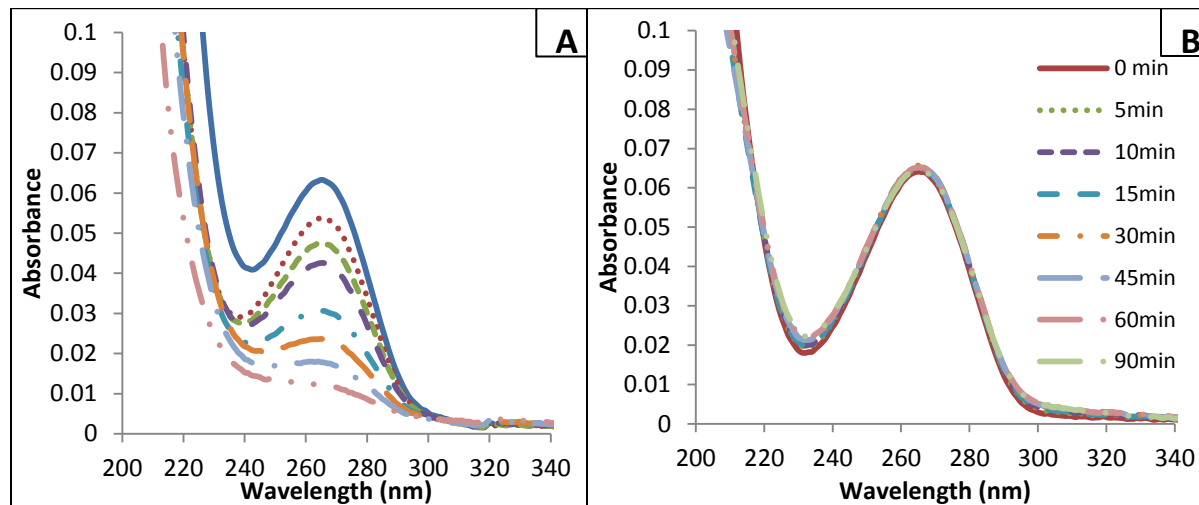
Changes of the concentrations of uracil at different reaction times were examined using observation of the changes of its absorbance at 258 nm and 290 nm. The natural log values of concentration ratio ( $C/C_0$ ) were then plotted against reaction time (Figure 18). The data shown in this figure show that the degradation of uracil proceed relatively rapidly at pH 7 and 9 while at pH 5.5 the reaction is considerably slower. This indicates the presence of strong effects of pH on the chlorination kinetics. These effects were examined in more detail for 5-FU.



**Figure 18** Concentration plot ( $\ln(C/C_0)$ ) of uracil over time at pH 5.5, 7, and 9 with uracil:Cl ratio of 1:18.

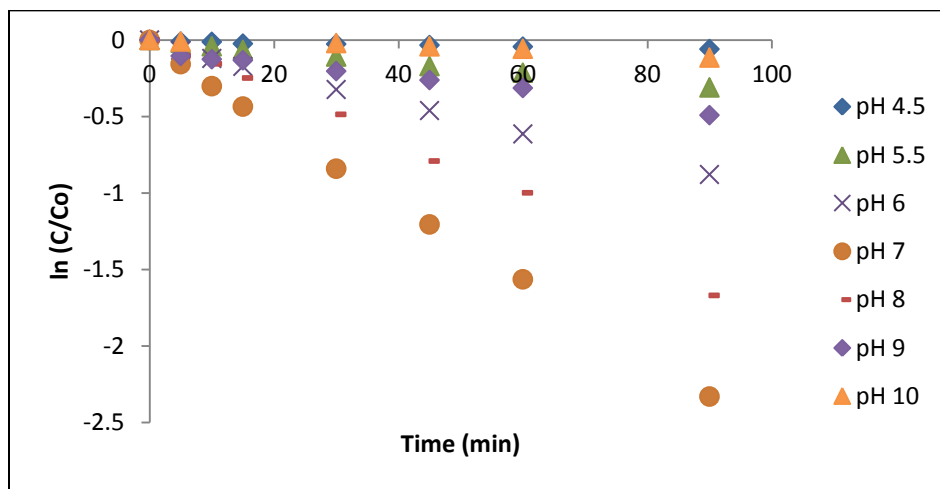
The spectrophotometric data for 5-FU at pH 7.0 and 4.5 in the presence of a 2 mg/l initial  $Cl_2$  concentration are shown in Figure 19. The positions of the absorbance peaks of 5-FU in figures are identical indicating that *per se* changes of pH in this range do not affect the

spectroscopic properties of 5-FU. However, the data indicate that 5-FU was relatively rapidly consumed at pH 7.0 while at pH 4.5 there was little change of its absorbance.



**Figure 19** Absorbance spectra of 5-FU for pH 7 (A) and 4.5 (B). Concentration of 5-FU and initial chlorine concentration are 0.2 and 2mg/l  $\text{Cl}_2$ , respectively. No added NaCl [35]

Changes of the concentrations of 5-FU at other pH varying from 4.5 to 10 are shown in Figure 20. They clearly show that the apparent of the degradation of 5-FU by chlorine reaches a maximum in the range of pHs close to 7 and its decreases at both higher and lower pHs.



**Figure 20** Changes of logarithms of the normalized concentrations of 5-FU ( $\ln(C/C_0)$ ) vs. time at varying pHs; 5-FU/ $\text{Cl}_2$  ratio 1:18.

### 3.3 Calculations of Apparent Reaction Rates

Prior research indicates that chlorination of uracil follows second order kinetics [30]. In this study, the rate of 5-FU chlorination was also assumed to follow this kinetic pattern. Because the initial chlorine concentration was much higher than that of 5-FU (weight ratio  $\text{Cl}_2/5\text{-FU}$  was 10 and the corresponding molar ratio was 18.3), calculations of the apparent kinetic rates assumed a pseudo first order reaction pattern. Rates of pseudo first order reactions of 5-FU hydrolysis and halouracil reactions with sodium bisulfate have been reported in prior literatures (albeit these reactions are not relevant to the studied system) [38, 39].

Within this approximation assuming the exists of second order kinetics at high  $\text{Cl}_2/5\text{-FU}$  ratios can be reduced to a pseudo-first order kinetics, the apparent rates are expected to be proportional to the total chlorine ( $\text{TOTCl}_2$ ) and, in the presence of bromide oxidized by chlorine to bromine species, on  $\text{TOTBr}_2$  as shown in equations 1 and 2 below:

$$\frac{d \text{TOT5FU}}{dt} = (-k_{app})(\text{TOTCl}_2)(\text{TOT5FU}) \quad (1)$$

$$\ln\left(\frac{\text{TOT5FU}}{\text{TOT5FU}_0}\right) = (-K_{app})(\text{TOTCl}_2)(t) \quad (2)$$

A summary of experimental  $k_{app}$  obtained for 5-FU chlorination at varying pHs and low concentration of background salt NaCl (<0.0001 M) is shown in Table 4. The graph of Table 4 is shown together with the model calculation.

**Table 4** Apparent kinetic rate for chlorination (0.2 ppm 5-FU and 2 mg/l Cl<sub>2</sub>) and bromination (8.56 μM KBr in 8.56 μM Cl<sub>2</sub>) of 5-Fluorouracil without NaCl addition [35, 40]

pH	Cl k <sub>app</sub> (sec <sup>-1</sup> mol <sup>-1</sup> ·L)	Br k <sub>app</sub> (sec <sup>-1</sup> mol <sup>-1</sup> ·L)
4.5	0.89	280
5.0	1.88	348
5.5	5.09	732
6.0	14.34	879
6.5	25.96	1231
7.0	36.87	1923
7.5	36.74	1255
8.0	26.82	428
8.5	15.57	194
9.0	7.04	74
9.5	3.33	-
10.0	1.98	-

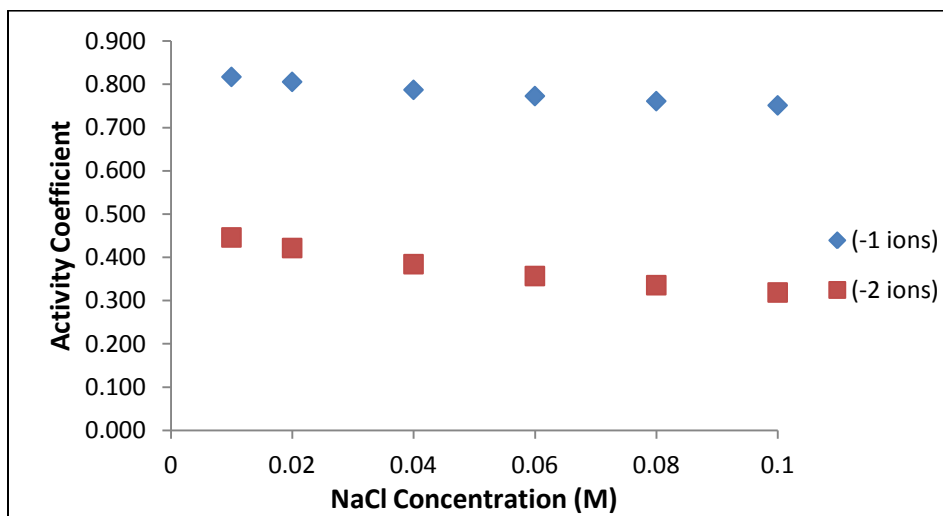
### 3.4 Effect of Sodium Chloride Concentrations

Sodium chloride was added in some experiments to the 5-FU solution to explore two possible effects. First, it was to probe effects of ionic strength variations of 5-FU chlorination and second, it was to examine possible contributions of the species of hydrated chlorine whose formation is expected to be promoted at higher chloride concentration (e.g., reactions T2.2 and T2.3 in Table 3).

The activity coefficients ( $\gamma$ ) of ionic participants in 5-FU chlorination reactions (e.g., OCl<sup>-</sup>, deprotonated form of 5-FU denoted as 5FU<sup>-</sup>) were calculated using the classical Davis equation (equation 3 below). The values of  $\gamma$  change as the concentration of sodium chloride increases due to increasing ionic strength as shown in Figure 21.

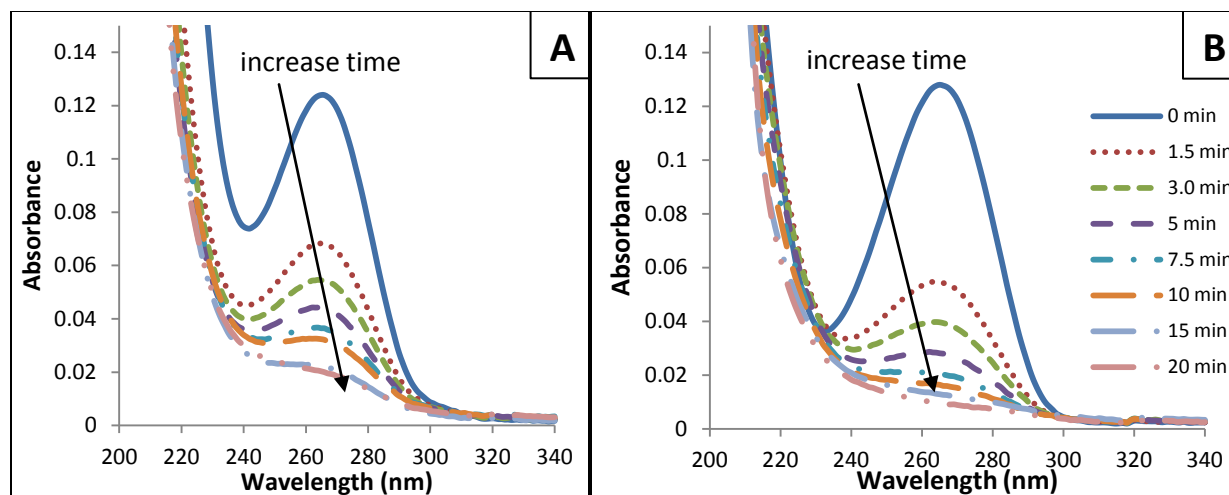
$$\text{Log}\gamma = -0.5z^2 \left( \frac{I^{0.5}}{1+I^{0.5}} - 0.2I \right) \quad (3)$$

The absorbance data for 5-FU at pH 7 and 4.5 with 1.74 mg/l Cl<sub>2</sub> and 0.06 M NaCl concentration are shown in Figure 22. The behavior of the spectra shown in this figure is generally similar to that shown in the absence of added NaCl but the degradation proceeded faster at higher NaCl concentrations (Figure 19). The effect was most notable at low pHs. For instance, at pH 4.5 in the absence of added NaCl the consumption of 5-FU was very slow; the reaction was very rapid in the presence of 0.06 M NaCl.



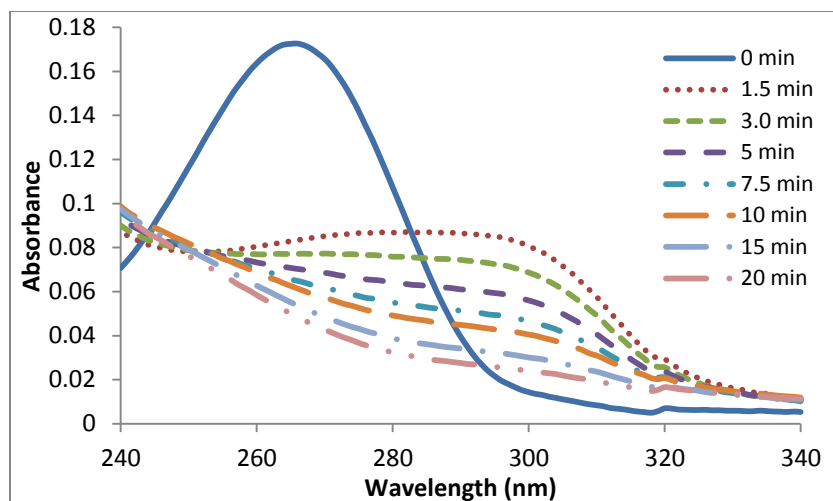
**Figure 21** Changes in nominal activity coefficient ( $\gamma$ ) for singly and doubly charge ions as a function of sodium chloride concentration increases

Examination of the data shown in Figure 22 and those generated in related experiments showed that increases of NaCl concentrations caused the apparent rates of 5-FU chlorination to accelerate. The extent of change of the apparent kinetics of 5-FU degradation by chlorine was far more significant than possible changes associated with variations of the activity coefficient of the ions engaged in this reaction.



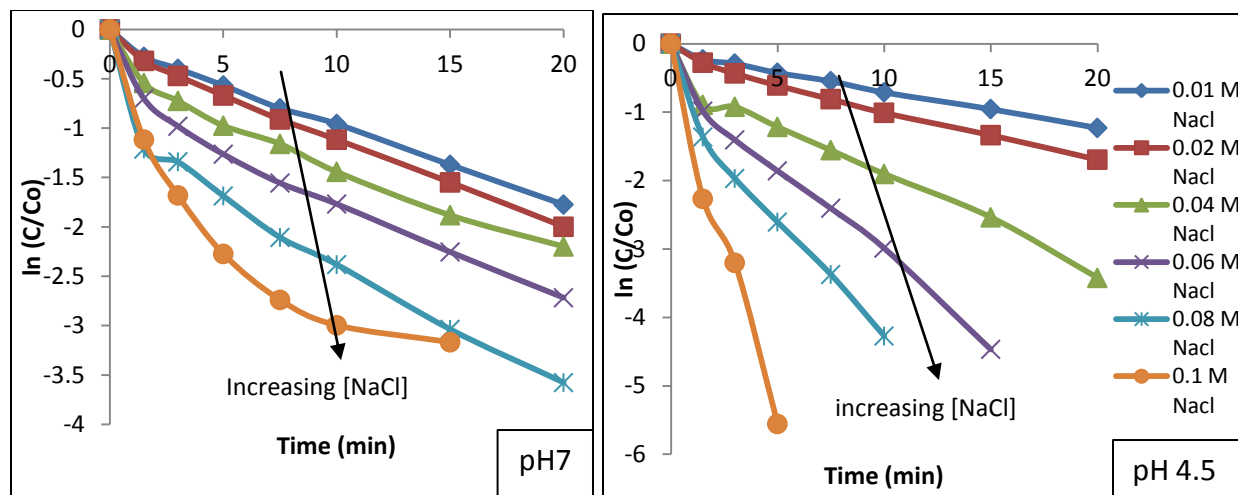
**Figure 22** Changes of absorbance spectra of 5-FU for pH 7 (A) and 4.5 (B) in the presence of 1.74 mg/l  $\text{Cl}_2$ . Initial 5-FU/ $\text{Cl}_2$  ratio of 8 and concentration of NaCl 0.06 M.

Further examination of the spectra of 5-FU in the presence of chlorine that was not quenched by  $\text{Na}_2\text{SO}_3$  (as was the case for the data shown in Figure 19) showed the presence of significant differences compared with the spectra recorded without the introduction of the reducing agent (Figure 23). The data shown in the latter figure also indicate the consumption of 5-FU and the apparent rate of such degradation were found to be similar to that quenched with sodium sulfite. However, the position of the peak in the spectra shown in Figure 23 is shifted toward longer wavelengths, similar to what was observed for uracil (Figure 17). The difference could be caused by both the existence of transient species of chlorinated 5-FU (which are reduced back to 5-FU by sodium sulfite). However, more detailed examination of non-quenched 5-FU/chlorine system was complicated by the presence of the absorption band of chlorine that has a maximum at ca. 290 nm, that is in the same region where the spectral features show in Figure 23 are located. For this reason, most of the experiments described in this thesis were conducted using samples quenched with sodium sulfite.



**Figure 23** Changes of absorbance spectra of 5-FU without quenching for pH 7 in the presence of 1.74 mg/l  $\text{Cl}_2$ . Initial 5-FU/ $\text{Cl}_2$  weight ratio of 8 and concentration of NaCl 0.06 M.

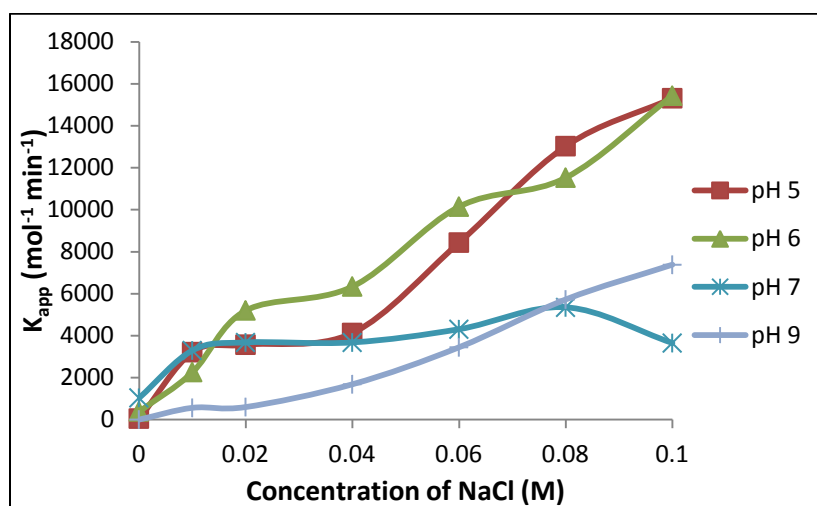
Effects of varying NaCl concentrations are demonstrated in more detail in Figure 24 for pH 7.0 and 4.5. These measurements demonstrated the existence of a nearly linear correlation between the concentration of NaCl and apparent kinetic rates at varying pHs, as shown in Figure 25.



**Figure 24** Plots of  $\ln(C/C_0)$  of 5-FU vs. time at various NaCl concentrations at pH 7 and 4.5 with 5-FU: $\text{Cl}$  molar ratio of 1:8. The  $C/C_0$  value of 0.1 M NaCl at time 20 min is not shown.

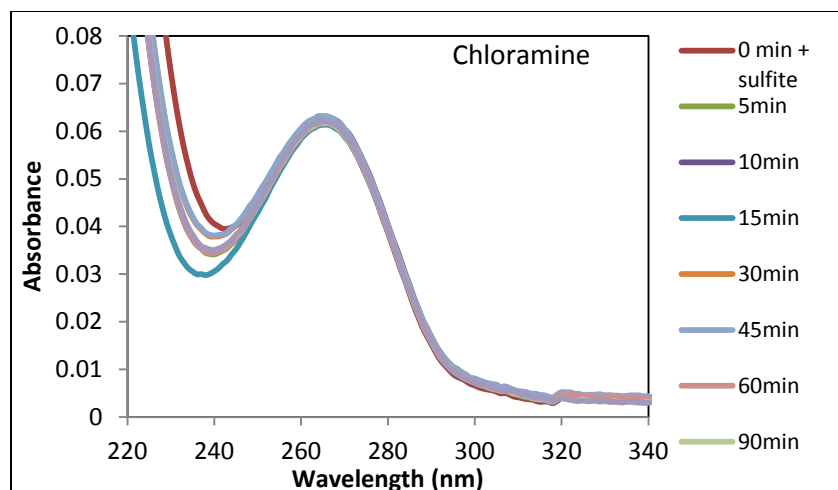
While these effects are to be important and they are indicative of the involvement of the species of hydrate chlorine in the degradation of 5-FU, repeated experiments with different

batches of NaCl also showed the lack of sufficient reproducibility in these experiments. This complication may be due to a number of reasons, for instance possible presence of impurities in stock solutions used in this study. It is possible that the used batch of NaCl contained a trace amount of NaBr. Given the dramatic increases of the rate of 5-FU bromination compared with those in the case of its chlorination, the possibility of increases of apparent rates of the degradation of 5-FU at elevated NaCl levels cannot be included. For this reason, further discussion of the observed effects of NaCl on the degradation will be deferred until reliable data for systems without possible contamination with bromide are obtained.



**Figure 25** Dependence of  $k_{app}$  with NaCl concentration at varying pHs

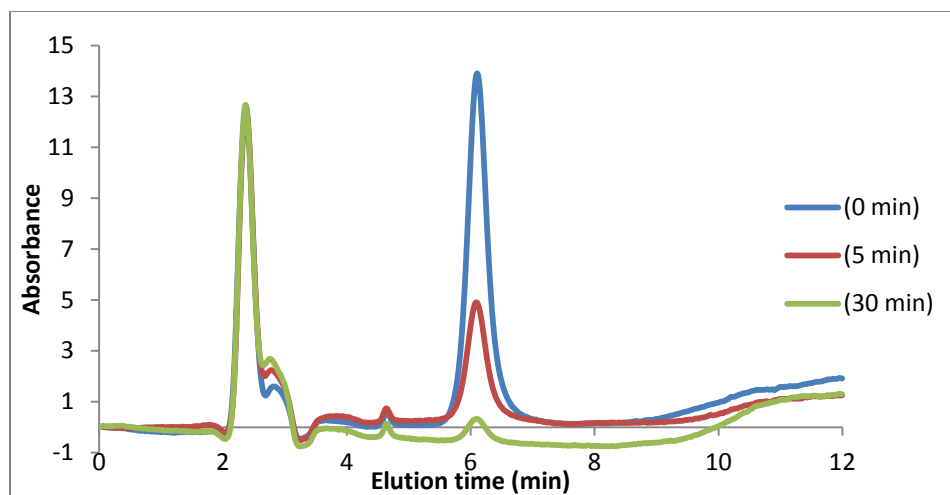
In addition for 5-FU degradation by chlorine, limited experiments were carried out to determine whether 5-FU could be degraded by another common form of chlorine disinfectant, chloramine. These experiments demonstrated that while some non-specific changes at wavelengths  $< 250$  nm took place in the presence of chloramine, the absorbance band of 5-FU itself did not exhibit any decrease after 90 minutes of reaction (Figure 26). Accordingly, it was concluded that in contrast with chlorine, chloramine *per se* does not degrade 5-FU.



**Figure 26** Absorbance spectra 5-FU in the presence of 2 mg/l chloramine, pH 7.0 [35]

The degradation of 5-FU by chlorine in more realistic conditions was also briefly examine for the case of filtered Lake Washington water spiked with 5-FU. The spectrophotometric methods developed to track transformations of 5-FU in the absence of NOM was determined to be insufficiently sensitive in the case of Lake Washington water due to the overlap of the relatively weak absorbance band of 5-FU and much more prominent absorbance of Lake Washington NOM which also had a pronounced peak at wavelengths close to that of the maximum of the 5-FU band. In this case, changes of the concentration of 5-FU were determined using the HPLC method described in the materials and methods section. These experiments showed a relatively rapid (within 30 minutes) degradation of 5-FU in the presence of 4 mg/l  $\text{Cl}_2$ , as shown in Figure 27.

While the HPLC measurements were not fully optimized, the formation of an insufficiently resolved peak located at a 2.6 minute elution time was noted. It is possible that this peak may correspond to the formation of yet to be identified products of 5-FU degradation but this issue will need to be explored in future research.



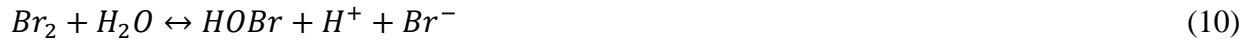
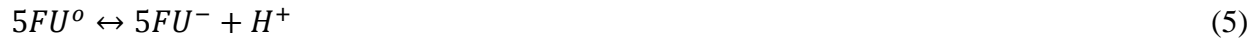
**Figure 27** HPLC data for the degradation of 5-FU in Lake Washington water. 4 mg/l initial  $\text{Cl}_2$  concentration,  $\text{Cl}_2/5\text{-FU}$  molar ratio of 8, concentration of NaCl 0.01 M.

### 3.5 Reaction Mechanism and Possible Reaction Scheme

To examine degradation rates and possible times of life times of 5-FU in a wide range of drinking water or wastewater treatment conditions, fundamental aspects of interactions between various 5-FU and halogen species were examined. The approach assumed that different form of chlorine and bromine species react with different intrinsic rates with protonated and neutral 5-FU molecules.

Initially, the modeling approach assumed that only two forms of 5-FU, namely its protonated and deprotonated form denoted as  $5\text{FU}^0$  and  $5\text{FU}^-$  existed in the system. However, attempt to fit the behavior of apparent kinetic rates of 5-FU degradation by chlorine (Figure 33) showed that no sufficiently good fitting could be obtained unless an assumption that in fact, in the presence of chlorine, 5-FU existed in three forms that were denoted as protonated form  $\text{H}5\text{FU}^+$ , neutral form  $\text{FU}^0$ , and deprotonated form  $\text{FU}^-$  in aqueous condition. The existence of the first of these species operationally denoted as  $\text{H}5\text{FU}^+$  was not expected based on the conventional acid/base equilibria of 5-FU with its reported pK value of 8.05 [16]. However, the necessity to introduce the species  $\text{H}5\text{FU}^+$  became clear in the modeling. Presumably, the effect is

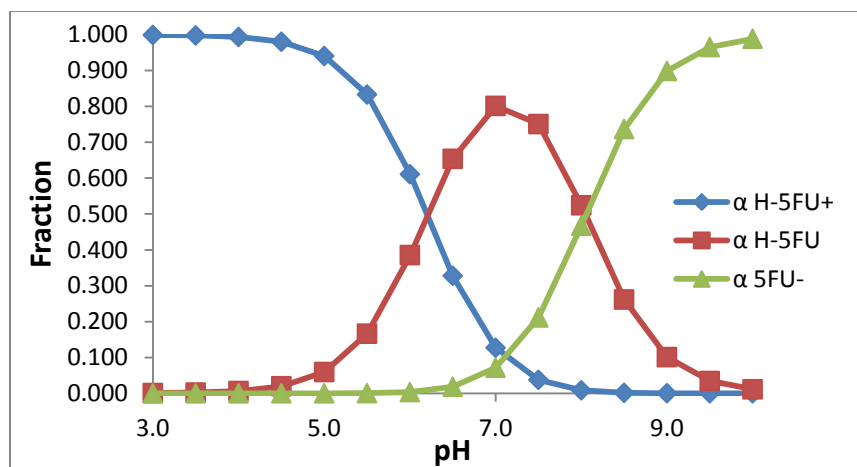
caused by initial product of 5-FU chlorination that has lower pK. The initial chlorination product hypothesized to form 5-FU back once quenched by Na<sub>2</sub>SO<sub>3</sub>. To simplify the model, the initial product pK is accounted as another 5-FU pK (further research needs to be done to clarify this initial product). Accordingly, the basic chemical equilibria between the system components that are likely to affect the rate of 5-FU chlorination or bromination were defined as shown below in equations 4 to 10:



The above sequence of reactions assumes that the major forms of chlorine are HOCl and OCl<sup>-</sup> while those of bromine are HOBr and OBr<sup>-</sup>. The formation of other chlorine or bromine species (e.g., Cl<sub>2</sub>, Cl<sub>3</sub><sup>-</sup>, Br<sub>2</sub>) is also postulated as shown by equations 6, 8 and 10. While kinetically these species may be very active, their equilibrium concentrations are non-negligible only at very low pHs (e.g., pH<3 for hydrated chlorine) in most drinking water or wastewater treatment situations. Other possible chlorine and bromine species, for instance bromine chloride BrCl could also be present (they are listed in Table 2 and Table 3) but for simplicity their formation was not considered.

As mentioned above, fitting of the experimental data showed the need to introduce the protonation of 5-FU as shown in equation 4. The pK of this protonation reaction was optimized

via the fitting of the observed  $k_{app}$  values vs. pH and it was determined to be  $\sim 6.40$ . Given the absence of observations of this species in measurements of 5-FU equilibria without chlorine, it was postulated that the formation of  $H5FU^+$  reflects the existence of a transient form of 5-FU. This structure appear to form as a reactive complex between 5-FU and chlorine species. The speciation diagram of 5-FU at various pH is shown in Figure 28.

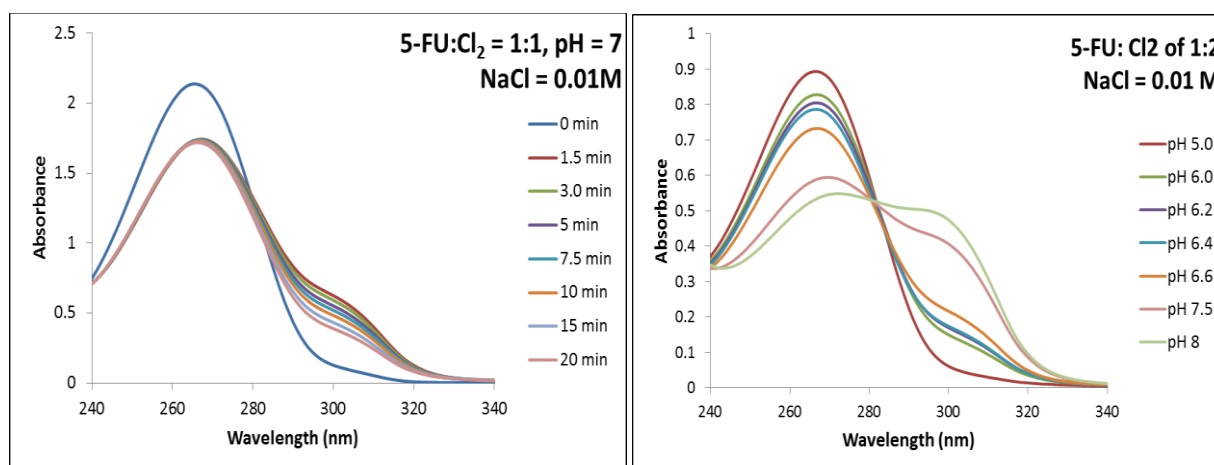


**Figure 28** Speciation diagram of 5-fluorouracil taking into account the other possible pKa at 6.4

Further examination of the experimental data showed that the form of 5-FU associated with the apparent pK of 6.4 is likely to be a chlorinated form of 5-FU whose presence was not explicitly accounted for in equations 4-10 but whose formation affected the kinetics and yields of 5-FU interactions with chlorine species

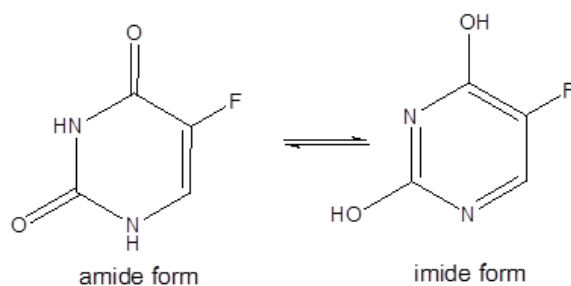
The presence of a mono-chlorinated form of 5-FU could be discerned from the absorbance spectra of 5-FU chlorinated using a 1:1 molar ratio (in Figure 29). For this system, the peak of 5-FU at 268 nm was quite stable while the peak of 300 nm formed at 1.5 minutes decreased slowly. Given that the shoulder at ca. 300 nm appears for non-chlorinated 5-FU only at  $pH > 8$ , its prominence at pH 7 indicates the presence of a compound that is considerably more acidic than 5-FU itself.

The increased acidity of the products of 5-FU chlorination could be tracked in more detail for 5-FU solution reacting with chlorine at a 2 initial  $\text{Cl}_2/5\text{-FU}$  ratio (Figure 29). For this system, the spectra of the system after the initial 7 minutes reaction time and measured for pHs varying between 5 and 8 showed the presence of a very prominent peak at 300 nm peak. Moreover, changes of the spectra with the pH demonstrated the presence of an isosbestic point indicating the occurrence of equilibrium between two species whose concentrations are affected by the pH. The exact chemical structure of the compound exhibiting the spectra shown in Figure 29 is unclear but it is postulated to be dichloro-5-FU. Fitting of the data shown in Figure 29 indicated that the apparent pK of dichloro-5-FU is 6.8. This is much close to the pK value found via the fitting of the apparent kinetic coefficients (pK 6.4).

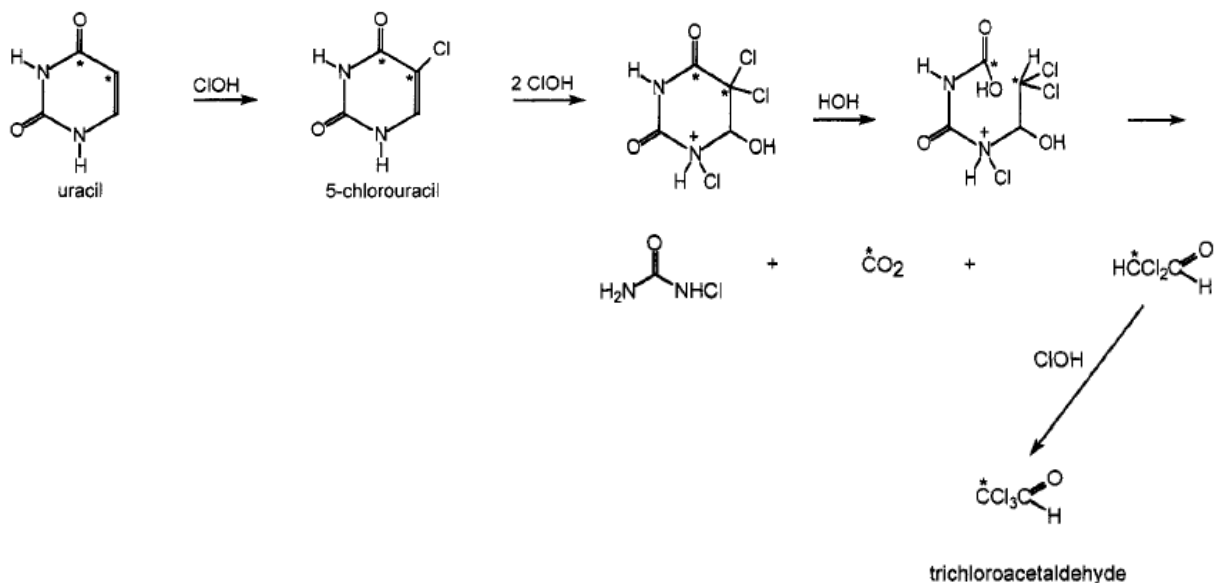


**Figure 29** Absorbance spectra of 5-FU in chlorine 1:1 ratio on left at various reaction time. The graph on right is 5-FU:  $\text{Cl}_2$  ratio of 1:2 various pHs at 7 minutes of reaction time.

The difference between the pKs obtained for dichloro-5-FU and via the fitting may be explained by the presence of transient species other than those shown in Figure 29. For instance, from general views on the reaction mechanism, we can postulate that 5-FU can participate in keto-enol tautomeric equilibria forming two forms shown below:

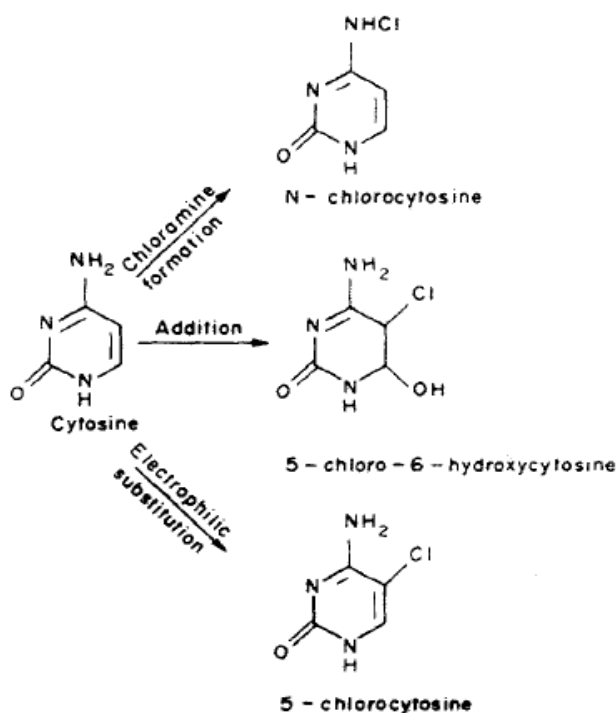


Given that the chlorination of 5-FU was not studied in prior research, possible reaction schemes of its chlorination can be developed based on the data for uracil and cytosine chlorination. According to prior research, the 5<sup>th</sup> and 6<sup>th</sup> carbons in uracil and cytosine molecules are more reactive than the other carbons in the pyrimididione ring [28, 30, 41, 42, 43]. Electrophilic substitution of one or more chlorine atoms at 5<sup>th</sup> carbon of the aromatic ring of uracil followed by chlorine addition to the aromatic nitrogen was proposed to be the main pathway for uracil chlorination as shown in Figure 30. Further hydrolysis reaction of 4<sup>th</sup> and 6<sup>th</sup> carbons might continue and cause ring cleavage.



**Figure 30** Proposed reaction pathway for uracil chlorination of Uracil:HOCl molar ratio of 8:1. Adopted from [28]

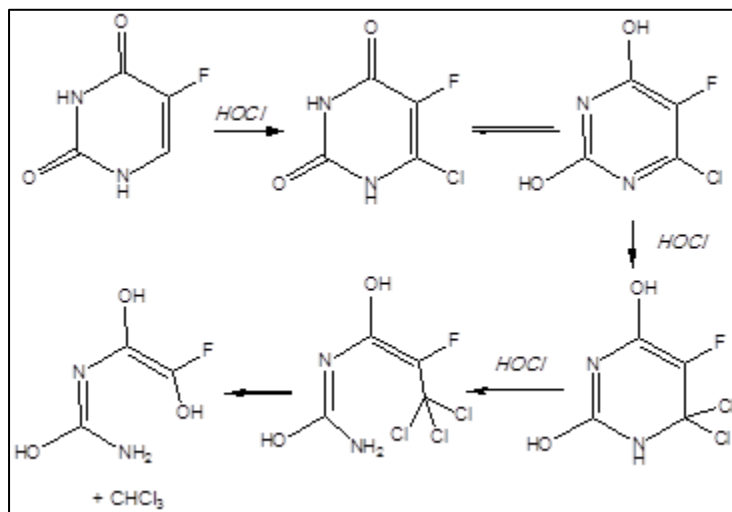
Aqueous chlorination of cytosine, on the other hand, might produce three different products according to different reaction mechanisms: chloramine formation, addition, and electrophilic substitution as shown in Figure 31. The chloramine formation was predicted to happen at  $\text{-NH}_2$  functional group. In uracil, however, the chloramine formation is predicted to be more likely to happen at the  $\text{>NH}$  of aromatic ring. This preference was examined by Prutz in faster reaction of chlorine with thymidine-5'-monophosphate that has  $\text{>NH}$  bond; these reactions were found to be faster than those of cytidine monophosphate that has addition of  $\text{-NH}_2$  functional group [42].



**Figure 31** Possible reaction pathway in cytosine chlorination reaction, adopted from [30]

Based on the reaction pathway suggested in prior research, an 5-FU reaction scheme was proposed. It assumes the existence of three possible chlorine electrophilic substitution sites in 5-FU at  $\text{>NH}$  group, 5<sup>th</sup> carbon, and 6<sup>th</sup> carbon. One of the sequence of reactions leading to the incorporation of chlorine at the carbon site and the subsequent breakdown of 5-FU molecules is

in Figure 32. This sequence also assumed the formation of a 5-FU imide tautomer after the chlorine substitution. It is also likely that chlorine substitution occurs at the 5<sup>th</sup> fluorinated carbon as shown in Figure 30 [28].



**Figure 32** Suggested scheme of 5-FU chlorination

### 3.6 Reaction Modeling

To further extract the experimental data of 5-FU chlorination at varying pHs, data modeling that assumed the presence of the acid-base equilibria discussed above was conducted. Theoretically, predicted speciation coefficients ( $\alpha$ ) of all solution components were calculated using the applicable pKa values, varying pH values and total reactant concentrations. When equations 11 and 12 are substituted to equation 9, the  $k_{app}$  equation is generated as shown in equation 13. Subsequently, the concentration of each species involved in the reactions can be determined.

$$TOTFU = (H5FU^+) + (5FU^o) + (5FU^-) \quad (11)$$

$$TOTCl_2 = (Cl_2) + (HOCl) + (OCl^-) \quad (12)$$

$$K_{app} = k_1(H5FU^+)(Cl_2) + k_2(H5FU^+)(HOCl) + k_3(H5FU^+)(OCl^-) + k_4(5FU^o)(Cl_2) + k_5(5FU^o)(HOCl) + k_6(5FU^o)(OCl^-) + k_7(5FU^-)(Cl_2) + k_8(5FU^-)(HOCl) + k_9(5FU^-)(OCl^-) \quad (13)$$

From this derivation, the degradation of 5-FU can be modeled by optimizing the reaction constant  $k_1$ - $k_9$  above. Further derivations of  $k_1$ - $k_9$  are shown in Appendix.

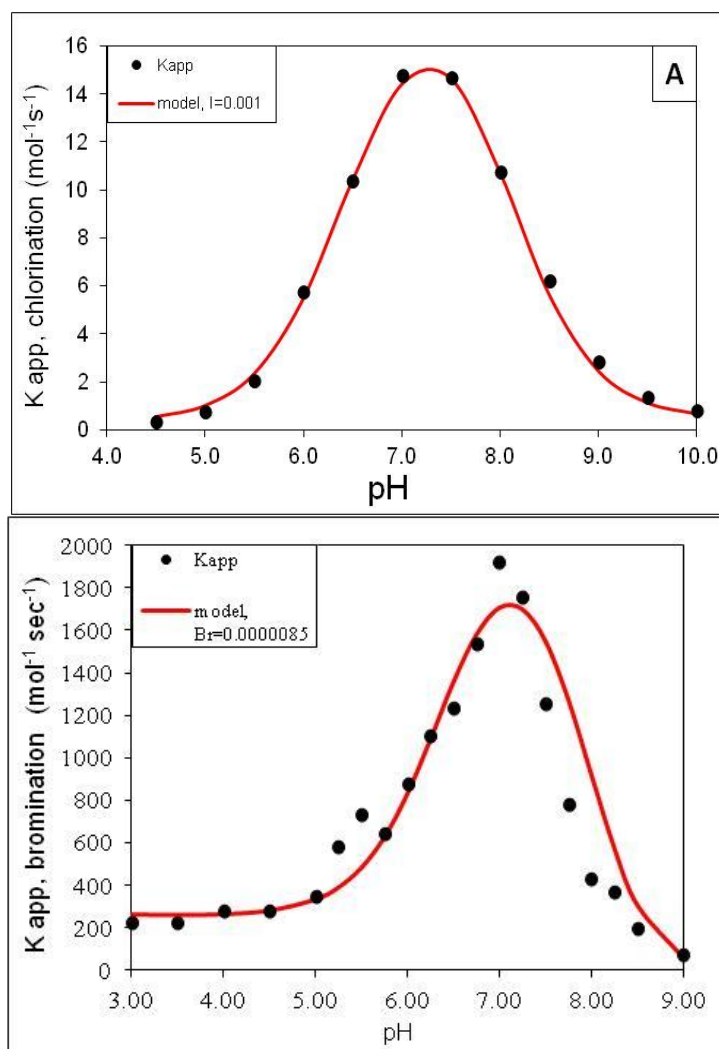
Apparent rate of reaction values predicted by the model can be calculated using equation 12. The  $k_i$  values in the theoretical expression can be obtained by fitting the modeling results to the experimental data using the genetic algorithm based software PIKAIA that operates with Microsoft Excel files [44]. The  $k_i$  values obtained via PIKAIA are compiled in Table 5 and the correspondence between the experimental and model data is also demonstrated in Figure 33. The experimental  $k_{app}$  values in Figure 33 are shown in Table 4.

**Table 5** Rate Constants for 5-FU Degradation in Chlorination (left) and Bromination (right) found by analytic modeling

$k_i$ ( $\text{sec}^{-1} \text{ mol}^{-1} \text{ l}$ )	Chlorination		Bromination	
$k_1$	0	$Cl_2 + H-FU^+$	2500	$Br_2 + H-FU^+$
$k_2$	1.00E+06	$Cl_2 + 5FU^o$	5.00E+05	$Br_2 + 5FU^o$
$k_3$	1.00E+11	$Cl_2 + 5FU^-$	0	$Br_2 + 5FU^-$
$k_4$	0	$HOCl + H-FU^+$	300	$HOBr + H-FU^+$
$k_5$	1100	$HOCl + 5FU^o$	2300	$HOBr + 5FU^o$
$k_6$	5000	$HOCl + 5FU^-$	0	$HOBr + 5FU^-$
$k_7$	0	$OCl^- + H-FU^+$	0	$OBr^- + H-FU^+$
$k_8$	1900	$OCl^- + 5FU^o$	0	$OBr^- + 5FU^o$
$k_9$	80	$OCl^- + 5FU^-$	0	$OBr^- + 5FU^-$

The data indicated that both experimental and predicted apparent rates of 5-FU removal were strongly pH-dependent reaching a maximum at pH close to 7.3. The apparent reaction rate of the chlorination reaction ranges from 1 to 16  $\text{l} \cdot \text{mol}^{-1} \text{ s}^{-1}$ . The presence of bromide led to a strong acceleration, maximum  $k_{app}$  around 1900  $\text{l} \cdot \text{mol}^{-1} \text{ s}^{-1}$ , of 5-FU removal due to the formation of more reactive bromine species. This is consistent with the well-known fact that bromine

species tend to be much more reactive than the analogous chlorine species in halogenation of organic species taking place in aqueous solution.

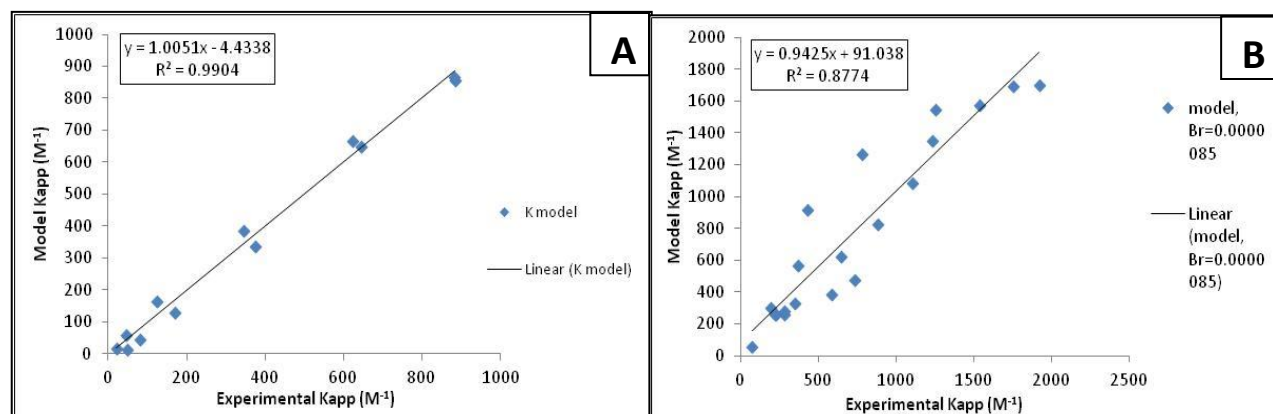


**Figure 33** Apparent rates of chlorination and model with 2 mg/l  $\text{Cl}_2$  and  $I = 0.001$  M (A) and bromination with  $8.6 \times 10^6$  M total bromide and low chlorine concentration (B) of 5-FU at varying pHs

While effects of NaCl concentrations need to be explored further, the current observations indicate that the rates of 5-FU removal increase at higher chloride levels especially notably at  $\text{pH} < 7$ . Examination of the intrinsic rates of halogenation of 5-FU indicated and hypochlorous and hypobromous acids ( $\text{HOCl}$  and  $\text{HOBr}$ ) were the most important halogenation

agents at  $\text{pH} > 7$  while at lower pHs hydrated chlorine and bromine ( $\text{Cl}_2$  and  $\text{Br}_2$ ) is likely to play an important role as described in the theory subsection.

The model accuracy was analyzed by plotting it against experimental apparent kinetic rate. Figure 34A shows that the model predicts the real behavior very closely in chlorination reaction with  $R^2 = 0.99$ . However, the bromination reaction model does not fit the experimental values as well as it does the chlorination data. The possible explanation of the difference is that because bromide species degrade 5-FU in short amount of time, the rapid degradation of 5-FU affected the accuracy of experimental data ( $R^2 = 0.88$ ). Still, we believe that despite the lower  $R^2$  (r-squared) value obtained for bromine reactions with 5-FU, the analytical model can be utilized to predict the behavior of 5-FU degradation in the presence of either chlorine or bromine.

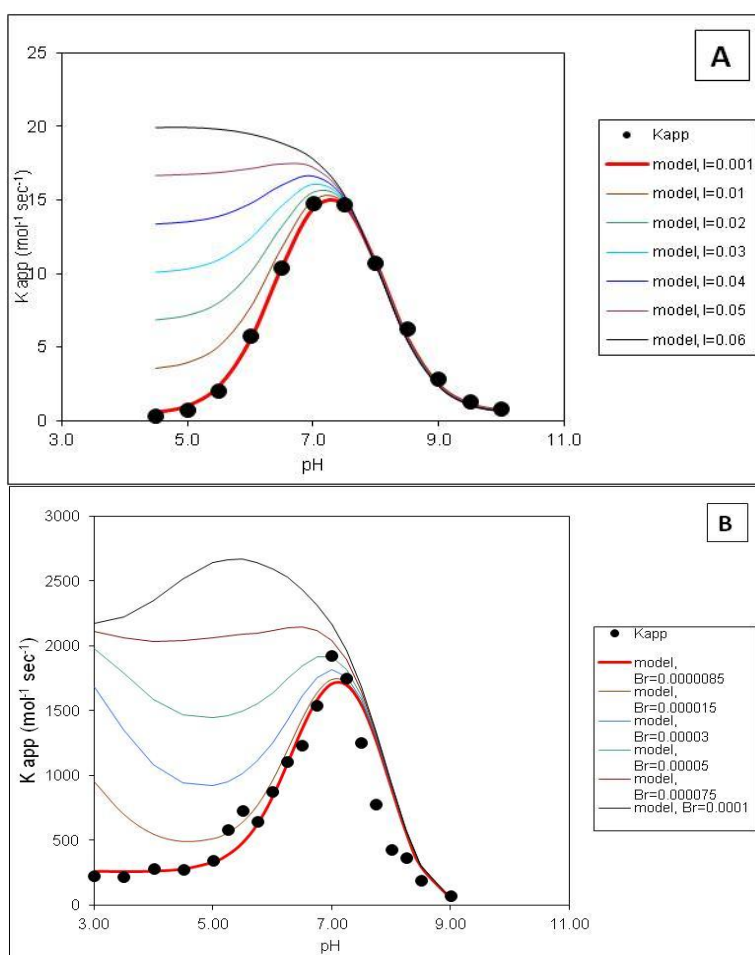


**Figure 34** Comparisons between calculated and experimental apparent kinetic rate of chlorination and bromination

As was mentioned above, the degradation of trace level contaminants in realistic conditions of aqueous halogenations occurs at varying concentration of common background ions that affect the ionic strength of the solution. The effect of ionic strength in our experiments was examined using varying concentrations of NaCl. The effect of ionic strength was more prominent at lower pH, especially  $\text{pH} < 6$ . At  $\text{pH} 4.5$  and  $0.06 \text{ M NaCl}$ , the experimental  $k_{app}$  for chlorine reaction was determined to be the higher than the maximum values at  $\text{pH} 7.3$  when no

salt was added to the solution. From this data it can be concluded that addition of NaCl might catalyze the halogenation of 5-FU due to the shift of the equilibria towards higher contributions of hydrated  $\text{Cl}_2$ .

The lack of repeatability in the experiments with varying NaCl concentrations made the exact modeling of the assumed effects of NaCl levels and associated variations ionic strength difficult. Still the available data can be used to make some predictions that are shown in Figure 35. These calculations predict that in the case of chlorination, increasing sodium chloride concentrations results in the increases of the  $k_{\text{app}}$  values for pH 4.5 to 7. In the bromination model, higher bromide concentrations cause  $k_{\text{app}}$  values to increase in acidic condition as well.



**Figure 35** Apparent kinetic constant for chlorination (A) and bromination (B) of 5-Fluorouracil with various activity by presence of NaCl (A) and KBr (B). The experimental  $k_{\text{app}}$  is the same as Figure 33.

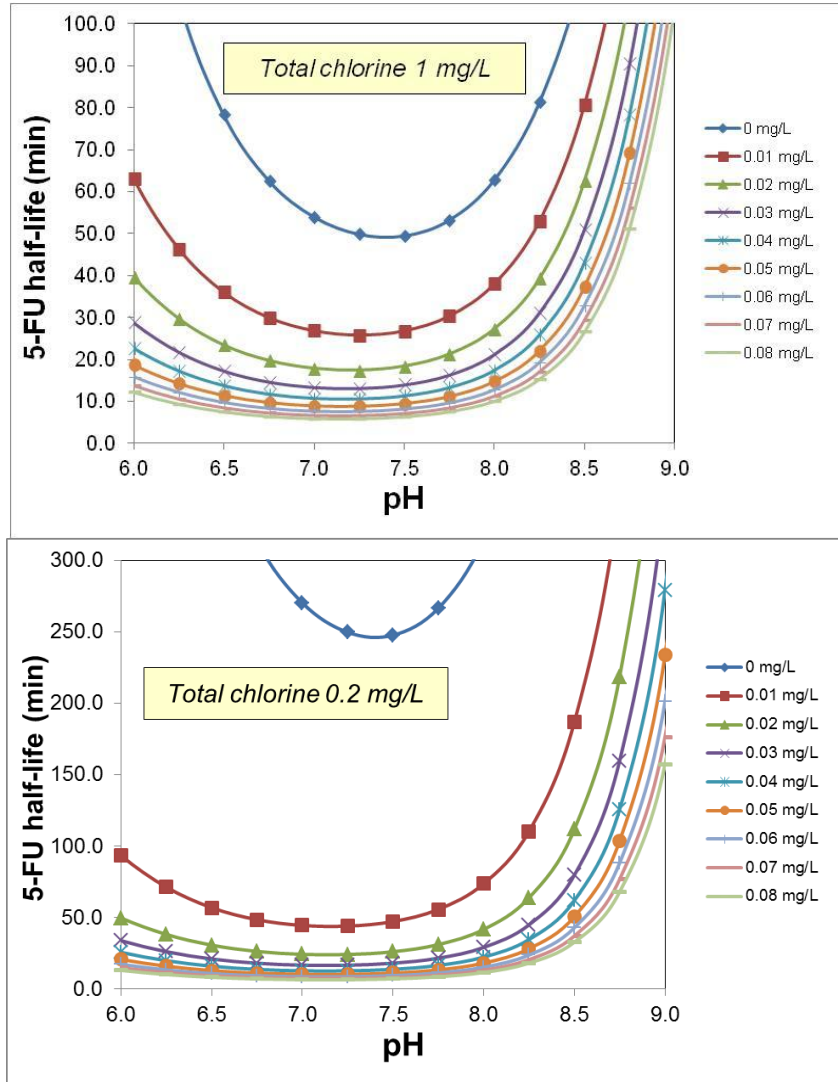
### 3.7 Estimations of half-times of 5-FU in treated water

Half-times of 5-FU estimated using the reaction constants discussed above and 1 mg/l concentration of chlorine in the presence of varying bromide is shown in Figure 36A. As mentioned before, the fastest reaction is observed around neutral pH and increasing bromide concentration will increase the rate of reaction thus decreasing the persistence of 5-FU. Its half-time can be obtained using the pseudo first order reaction rates and the conventional expression of  $\tau_{1/2}=0.69/k_{app}$ .

Modeling of the half-times of 5-FU in chlorinated water showed that for a typical chlorine concentration of 1 mg/L and in the absence of bromide, 50% of 5-FU can be removed within ca. one hour of exposure at pHs close to 7.3. At higher and lower pHs, the required exposure times is much higher. However, the presence of bromide at levels as low as 10 to 20  $\mu\text{g/L}$  leads to the removal of 5-FU within minutes of exposure. The half-times of acidic condition are less than alkaline condition. The difference of the half-times at varying pH below 8 is not much at higher bromide concentration (0.08 mg/l). 5-FU might be degraded very slowly at pH above 9 where the calculated half-time increase almost exponentially.

At lower chlorine concentration (0.2 mg/l), the half-time of 5-FU degradation in chlorine increased to 250 minutes in the absence of bromine as shown in Figure 36B. The 5-FU half-time degradation is significantly reduced when bromine present, even at 0.01 mg/l concentration.

The average chlorine contact time in typical wastewater treatment is 30 minutes [45]. In 30 minutes, most of the 5-FU will be fully degraded when 0.08 mg/l is bromine present in the treated water, without taking into account effects of NOM or other components reacting with chlorine and bromine species. For a 0.01 mg/l of bromine in surface water that is typical for many wastewater, there will be still some 5-FU left after wastewater disinfection treatment. Its further attenuation is likely to be photodegradation as was discussed in [34].



**Figure 36** Dependence of estimated half-lives of 5FU at varying pHs and bromide concentrations at total chlorine concentration of 1 mg/L and 0.2 mg/l.

## 4. CONCLUSION

The presence of PPCP in wastewater and surface water had been detected by various studies. Antineoplastic (chemotherapeutic) drugs form a separate group of PPCPs. The main source of these drugs is hospital wastewater although more drugs are also taken outpatiently. 5-FU is one of the typical and widely used drugs taken outpatiently for treatment of colorectal, pancreatic, and breast cancer. In this study, the kinetic and rate of 5-FU degradation caused by reactions that occur during the most widely used disinfection process, chlorination was analyzed. Effects of pH, concentrations of bromide and chlorine, and sodium chloride on the rates of 5-FU degradation were determined.

Reaction of 5-FU with chlorine took place in a flask covered with aluminum foil. NaOCl was used as the free chlorine source. The solution was buffered and adjusted for pH range 4.5 – 10. Quenched samples taken at various times of reaction were analyzed using UV spectrophotometry. Intensities of the second derivatives of 5-FU absorbance at 268 nm and 294 nm wavelengths were correlated to 5-FU concentration to measure the degradation rate.

5-FU was determined to degrade relatively rapidly at the range of pH 7 to 8, especially in the presence of bromide that forms more kinetically active species of bromine when bromide is oxidized by chlorine. The  $k_{app}$  of chlorination at pH 7 is  $38.9 \text{ sec}^{-1}\text{M}^{-1}$  while that in the case of bromination is  $1923 \text{ sec}^{-1}\text{M}^{-1}$ .

In addition to the prominent and consistent effects of pH, NaCl concentrations also affected the degradation of 5-FU. In general, increasing NaCl concentrations caused the chlorination rates to increase, sometimes significantly. At pH <7, 5-FU was relatively stable at low NaCl concentrations but the rates of its removal increased at higher salinities apparently due to a higher prevalence of hydrated molecular chlorine. At higher pH, 5-FU becomes considerably

more stable even in the presence or relatively high chlorine doses and/or contact times. The presence of more reactive bromine species accelerates the 5-FU removal in all cases but in realistic conditions this effect is likely to be moderated due to potentially fast consumption of bromine by effluent organic matter present in wastewater effluents.

The apparent kinetic rates of the model were calculated using elementary kinetic rates ( $k_i$ ) that corresponds to different species of 5-FU and chlorine/ bromine. The optimum  $k_i$  values were obtained from PIKAIA genetic algorithm modeling. In chlorination reactions, neutral and deprotonated 5-FU were concluded to be dominant in reactions with  $\text{Cl}_2$ ,  $\text{HOCl}$ , and  $\text{OCl}^-$ . On the other hand, the protonated and deprotonated 5-FU were dominant in the bromination reaction. Another pK of 5-FU at  $\sim 6.4$ , which might corresponds to the initial chlorinated 5-FU product, needed to be introduced in order to fit the model with the experimental results. This value might correspond to the effect of chlorine on the increased acidity of intermediate products formed upon the chlorination of the parent compound. Further investigation of the intermediate compound needs to be conducted. The final model of 5-FU degradation with chlorine in the absence of bromine predicts the increase of  $k_{\text{app}}$  values at  $\text{pH} < 7$  as the NaCl concentration increases. High presence of bromine might increase the peak of  $k_{\text{app}}$  values at  $\text{pH} 5.5$ . In chlorination and bromination reaction models, the reactivity of 5-FU at alkaline condition was far less than in acidic condition.

The results of these experiments show that water treatment conditions play a critical role in the removal of 5-FU and potentially other trace-level emerging contaminants that may be present in drinking water supplies. The actual degradation of 5-FU by halogens in a wide range of conditions can be modeled using the rate constants obtained in this study.

Further research is needed to establish the nature of intermediates and products formed in reactions of halogenation of 5-FU and other antineoplastic agents. The organic chemistry of the possible reaction scheme also needs to be investigated further. Chemical structures and yields of possible products of 5-FU chlorination still need to be established, together with their toxicities. Reaction of excess 5-FU with chlorine or reaction using stop-flow machine might be helpful to analyze the products and intermediates formed in the 5-FU chlorination reaction. Furthermore, in-depth statistical analysis of 5-FU chlorination reaction and modeling is also important. Effects of chlorine on antineoplastic agents other than 5-FU also need to be examined to ascertain their persistence in treated drinking water or wastewater.

## 5. Bibliography

- [1] Hirsch, R., Ternes, T. Haberer, K., and Kratz, K.L. , "Occurrence of antibiotics in the aquatic environment," *Science of the Total Environment*, pp. 225, 109-118, 1999.
- [2] Al-Ahmad, A., Daschner, F.D., and Kummerer, K, "Biodegradability of cefotiam, ciprofloxacin, meropenem, penicillin G, and sulfamethoxazole and inhibition of waste water bacteria," vol. 37, no. 2, pp. 158-63, 1999.
- [3] Kummerer, K., and Al-Ahmad, A., "Biodegradability of the anti-tumour agents 5-fluorouracil, cytarabine, and gemcitabine: Impact of the chemical structure and synergistic toxicity with hospital effluent.," vol. 25, no. 4, pp. 166-172, 1997.
- [4] O.A.H Jones, N. VOULVOULIS, and J. N. LESTER, "Human Pharmaceuticals in Wastewater Treatment Process," vol. 35, no. 4, pp. 401-427, 2005.
- [5] Kolpin, D.W., Furlong, E.T., Meyer, M., Thurman, E.M., Zaugg, S.D., Barber, L.B., and Buxton, H.T., "Pharmaceuticals, hormones, and other organic wastewater contaminants in U.S. streams, 1999-2000: A national reconnaissance," vol. 36, no. 1202-1211, 2002.
- [6] J. O. Straub, "Combined Environmental Risk Assessment for 5-Fluorouracil and Capecitabine in Europe," vol. 6, no. 1, pp. 540-566, 2009.
- [7] Zounkova, R, L Kovalova, L Blaha, and W Dott, "Ecotoxicity and Genotoxicity Assessment of Cytotoxic Antineoplastic Drugs and Their Metabolites," vol. 81, no. 2, pp. 253-260, 2010.
- [8] T. Heberer, "Occurrence, Fate, and Removal of Pharmaceutical Residues in the Aquatic Environment: a Review of Recent Research Data," vol. 131, no. 1-2, pp. 5-17, 2002.
- [9] B. Halling-Sørensen, N. Nielsen, P.F. Lansky, F. Ingerslev, L. Hansen, H.C. Lützhøft, S.E. Jørgensen, "Occurrence, fate and effects of pharmaceutical substances in the environment—a review," vol. 36, no. 2, pp. 357-394, 1998.
- [10] T. Ternes, "Occurrence of drugs in German sewage treatment plants and rivers," vol. 32, no. 11, pp. 3245-3260, 1998.
- [11] Garrett, Reginald H.; Grisham, Charles M. , *Principals of Biochemistry with a Human Focus*, Brooks/Cole Thomson Learning, 1997.
- [12] E. Brown, *Ring Nitrogen and Key Biomolecules: The Biochemistry of N-Heterocycles*, Boston: Lluwer Academic Publishers, 1998.
- [13] Krokan HE, Drabløs F, and Slupphaug G, "Uracil in DNA--occurrence, consequences and repair," vol. 21, no. 58, pp. 8935-48, 2002.
- [14] "Guide to Cancer Drug: 5-Fluorouracil," American Cancer Society, Inc, 2012. [Online]. Available: <http://www.cancer.org/Treatment/TreatmentsandSideEffects/GuidetoCancerDrugs/fluorouracil>. [Accessed November 2012].
- [15] Deborde, M., Rabouan, S., Gallard, H., and Legube, B., "Aqueous Chlorination Kinetics of Some Endocrine Disruptors.," vol. 38, no. 21, pp. 5577-5583, 2004.

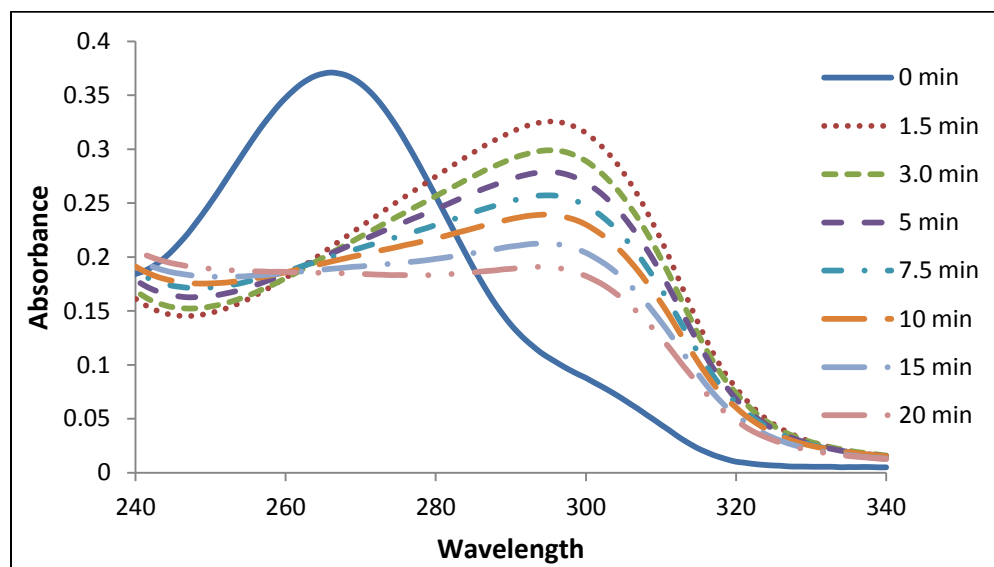
- [16] Sanli, N, S Sanli, and G Alsancak, "Determination of Dissociation Constants of Folinic Acid (leucovorin), 5-Fluorouracil, and Irinotecan in Hydro-Organic Media by a Spectrophotometry Method," vol. 55, no. 8, pp. 2695-2699, 2010.
- [17] "New Medicare Bill Targets Discrepancies in Fees for Cancer Drugs, Outpatient Services," vol. 96, no. 3, pp. 166-168, 2005.
- [18] "Cancer care migrates to outpatient setting," Medical Distribution Solutions, Inc., 16 June 2011. [Online]. Available: <http://www.jhconline.com/cancer-care-migrates-to-outpatient-setting-2.html>. [Accessed 23 May 2013].
- [19] M. J. McGuire, *The Chlorine Revolution: Water Disinfection and the Fight to Save Lives.*, American Water Works Assn, 2013.
- [20] Lawrence Y.C. Leong, Jeff Kuo, Chi-Chung Tang, "Disinfection of Wastewater Effluent - Comparison of Alternative Technologies," Water Environment Research Foundation, 2008.
- [21] G. V. Korshin, "Chapter 12: Chlorine Based Oxidants for Water Purification and Disinfection.," vol. no. 1071, pp. 223-246, 2011.
- [22] Heller-Grossman, L.; Idin, A.; Limoni-Relis, B.; Rebhun, M, "Formation of cyanogen bromide and other volatile DBPs in the disinfection of bromiderich lake water," vol. 33, no. 6, pp. 932-937, 1999.
- [23] Richardson, S.D. ; Thruston, A.D.; Rav-Acha, C.; Groisman, L.; Popilevsky, I.; Juraev, O. ; Glezer, V.; McKague, A.B. ; Plewa, M.J. ; Wagner, E.D., "Tribromopyrrole, brominated acids, and other disinfection byproducts produced by disinfection of drinking water rich in bromide," vol. 37, no. 17, pp. 932-937, 2003.
- [24] Haag, W.R.; Hoigne, J., "Ozonation of bromide-containing waters: kinetics of formation of hypobromous acid and bromate," vol. 17, no. 5, p. 261-267, 1983.
- [25] Odeh, I.N.; Nicolson, J.S.; Hartz, K.E.H.; Margerum, D.W., "Kinetics and mechanisms of bromine chloride reactions with bromite and chlorite," vol. 43, no. 23, pp. 7412-7420, 2004.
- [26] Deborde, M. and von Gunten U., "Reactions of chlorine with inorganic and organic compounds during water treatment - Kinetic and mechanisms: a critical review," vol. 42, no. 1, pp. 13-51, 2008.
- [27] Tchobanoglous, G.; Burton, F.L.; Stensel, D.H. , *Wastewater Engineering Treatment and Reuse*, Boston: McGraw Hill, 2003.
- [28] Young, M.S. and Uden, P.C., "Byproducts of the Aqueous Chlorination of Purines and Pyrimidines," vol. 28, pp. 1755-1758, 1994.
- [29] Joss A, Zabczynski S, Göbel A, Hoffmann B, Löffler D, McArdell CS, Ternes TA, Thomsen A, Siegrist H, "Biological degradation of pharmaceuticals in municipal wastewater treatment: proposing a classification scheme," vol. 40, no. 8, pp. 1686-96, 2006.
- [30] Gould J.P., Richards, J.T., Miles, M.G., "The Kinetics and Primary Products of Uracil Chlorination," vol. 18, no. 2, pp. 205-212, 1984.
- [31] Gould, J.P. and Hay, T.R., "The nature of the Reaction between Chlorine and Purine Pyrimidine bases: Products and Kinetics," Capetown, South Africa, 1982.
- [32] Shang, S., Gong, L and E. Blatchley III, "Breakpoint Chemistry and Volatile Byproduct Formation

- Resulting from Chlorination of Model Organic-N Compounds," vol. 34, pp. 1721-1728, 2000.
- [33] Baronti, C.; Curini, R.; D'Ascenzo, G.; Di Corcia, A.; Gentili, A.; Samperi, R., "Monitoring natural and synthetic estrogens at activated treatment plants and river water," vol. 34, pp. 5059-66, 2000.
- [34] Angela Yu-Chen Lin, Xiao-Huan Wang, and Wan Ning Lee, "Phototransformation determines the fate of 5-fluorouracil and cyclophosphamide in natural surface water," 2013 (Publication).
- [35] Venkateswarlu Nanaboina, Wei Li, and Gregory Korshin, "Study of the Effect of Ozone and Chlorine in Anticancer Drugs Degradation," 2013.
- [36] Nanaboina, V. and Korshin, G. V., "Evolution of Absorbance Spectra of Ozonated Wastewater and Its Relationship with the Degradation of Trace-Level Organic Species," vol. 44, pp. 6130-6137, 2010.
- [37] Ganguly, S. and Kundu, K.K., "Protonation/deprotonation Energetics of Uracil, Thymine, and Cytosine in Water from e.m.f./spectrophotometric measurements," vol. 72, pp. 1120-1126, 1994.
- [38] Garrett, ER, HJ Nestler, and A Somodi, "Kinetics and Mechanisms of Hydrolysis of 5-Halouracils," vol. 33, no. 9, pp. 3460-8, 1968.
- [39] Rork, G S, and Ian H. Pitman, "Kinetic Study of the Dehalogenation of 5-Chloro-, 5-Bromo-, and 5-Iodouracil in Aqueous Solutions of Sodium Bisulfite," vol. 97, no. 19, pp. 5559-5565, 1975.
- [40] Takaaki Masuyama, Gregory V. Korshin, and Oliver Saavedra, "Effect of bromine in 5-fluorouracil chlorination," 2012.
- [41] Darwanto A., Ngo L., and Sowerls, L.C., "Chapter 6 pyrimidine Damage and Repair," vol. 2, no. C, pp. 153-182, 2008.
- [42] W. A. Pru<sup>tz</sup>, "Interactions of Hypochlorous Acid with Pyrimidine Nucleotides, and Secondary Reactions of Chlorinated Pyrimidines with GSH, NADH, and Other Substrates," vol. 349, no. 1, pp. 183-191, 1998.
- [43] W. A. Pru<sup>tz</sup>, "Reactions of Hypochlorous Acid with Biological Substrates Are Activated Catalytically by Tertiary Amines," vol. 357, no. 2, pp. 265-273, 1998.
- [44] "Models for Total Maximum Daily Load Studies," Access Washington, 2013. [Online]. Available: <http://www.ecy.wa.gov/programs/eap/models.html>. [Accessed June 2013].
- [45] F. R. Spellman, Handbook of Water and Wastewater Treatment Plant Operations, Boca Raton, Fla: Lewis Publishers, 2003.
- [46] "5 Fluorouracil," National Cancer Institute at the National Institutes of Health, 2013. [Online]. Available: <http://www.cancer.gov/drugdictionary?cdrid=43130>.
- [47] Metcalfe, C. D.; Metcalfe, T. L.; Kiparissis, Y.; Koenig, B. G.; Khan, C.; Hughes, R. J.; Croley, T. R.; March, R. E.; Potter, T, "Estrogenic potency of chemicals detected in sewage treatment plant effluents as determined by in vivo assays with Japanese medaka (*Oryzias latipes*)," vol. 20, no. 2, pp. 297-308, 2001.
- [48] Gray, M. A.; Metcalfe, C. D., "Induction of testis-ova in Japanese medaka (*Oryzias latipes*) exposed to p-nonylphenol," pp. 1082-1086, 1997.
- [49] Gallard, H. ; Leclercq, A. ; Croué, J.P, "Chlorination of bisphenol A: kinetics and by-products formation," vol. 56, no. 6, pp. 465-473, 2004.

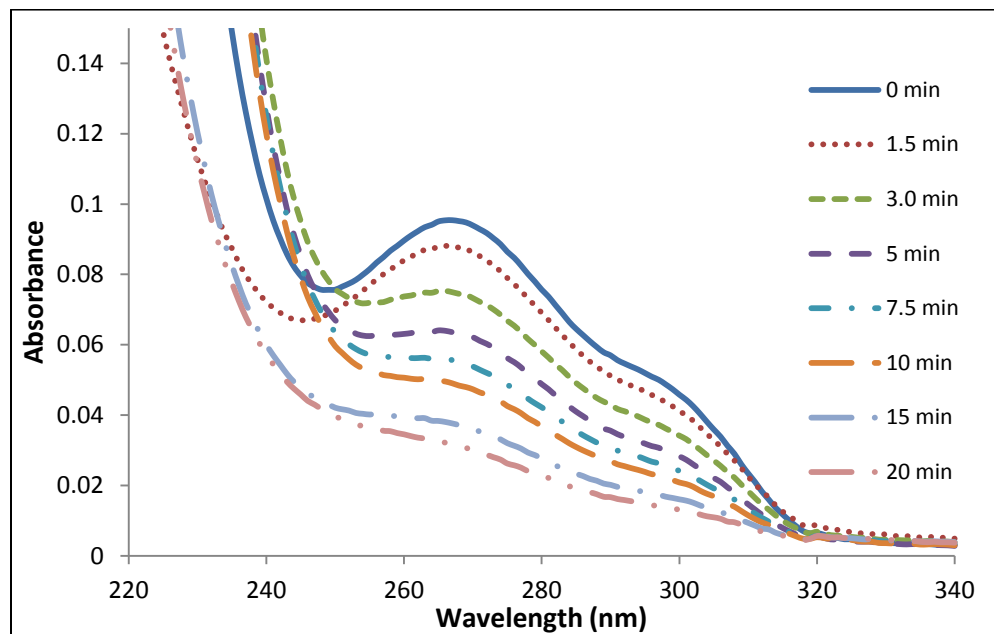
- [50] Westerhoff, P.; Yoon, Y.; Snyder, S.; Wert, E., "Fate of endocrine-disruptor, pharmaceutical, and personal care product chemicals during simulated drinking water treatment processes.," vol. 39, no. 17, pp. 6649-6663, 2005.
- [51] Lu, J.; Korshin, G.V., "A spectroscopic study of the bromination of the endocrine disruptor ethynyl estradiol.," vol. 72, no. 8, pp. 504-508, 2008.
- [52] V. Sharma, "Oxidative transformations of environmental pharmaceuticals by Cl<sub>2</sub>, ClO<sub>2</sub>, O<sub>3</sub> and Fe(VI): kinetics assessment," vol. 73, no. 9, pp. 1379-1386, 2008.
- [53] Faust, S.D.; Ali, O.M., Chemistry of Water Treatment, Ann Arbor Press, 1998.
- [54] Hu, J. Y.; Cheng, S.; Aizawa, T.; Terao, Y.; Kunikane, S., "Products of aqueous chlorination of 17 beta-estradiol and their estrogenic activities," vol. 37, pp. 5665-5670, 2003.
- [55] "Chloride in Wastewater," [Online]. Available: :  
<http://www.eolss.net/EolssSampleChapters/C06/E6-13-04-05/E6-13-04-05-TXT-04.aspx#3>.

## 6. Appendix

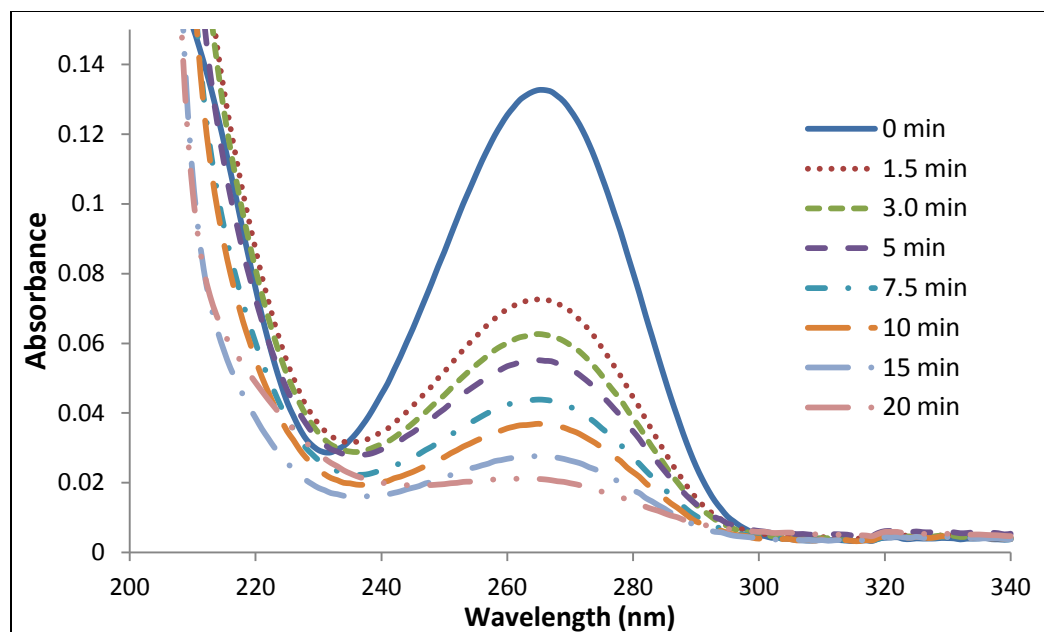
### 6.1 Supporting Figures



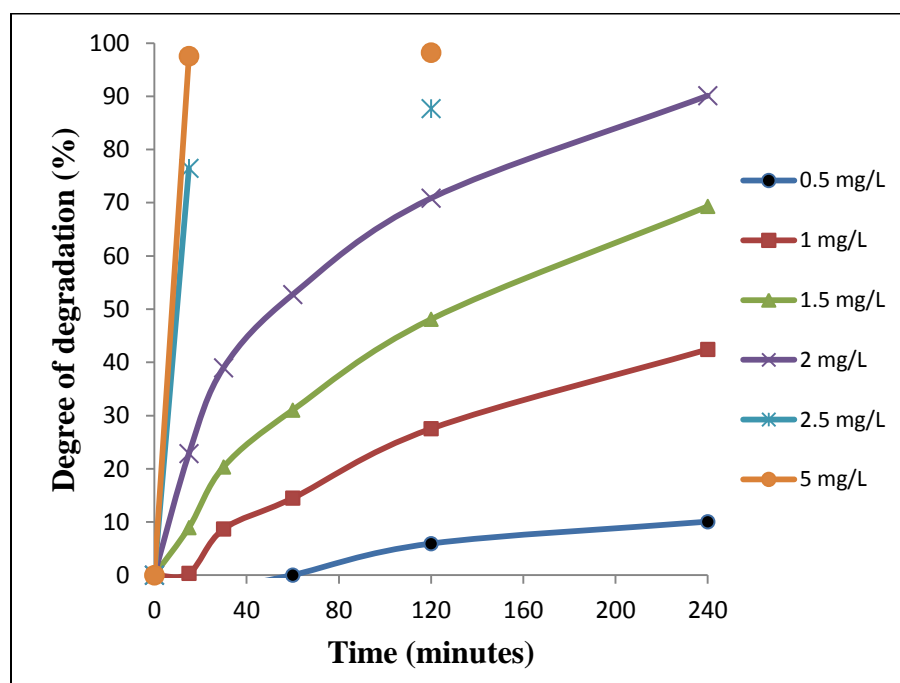
**Figure A1** Absorbance spectra of 5-FU for pH 8 in 1.74 mg/l  $\text{Cl}_2$ , 5-FU:Cl ratio of 1:8, and 0.06M NaCl, no quenching



**Figure A2** Absorbance spectra of 5-FU for pH 9 in 1.74 mg/l  $\text{Cl}_2$ , 5-FU:Cl ratio of 1:8, and 0.06M NaCl, quenched with  $\text{Na}_2\text{SO}_3$



**Figure A3** Absorbance spectra of 5-FU for pH 5 in 1.74 mg/l  $\text{Cl}_2$ , 5-FU:Cl ratio of 1:8, and 0.06M NaCl, quenched with  $\text{Na}_2\text{SO}_3$



**Figure A4** Percent removal of 5-FU at various degree of chlorination and reaction time. Total degradation is only noticed at 5 mg/l  $\text{Cl}_2$ . Adopted from [35].

## 6.2 Derivation of apparent rate of reaction rate of 5-FU chlorination

Principal reactions mentioned in text are:



The apparent second derivative for the chlorination and bromination are:

$$\frac{d5FU}{dt} = (-K_{app})(TOTFU)(TOTCl_2) \quad (1)$$

$$\frac{d5FU}{dt} = (-K_{app})(TOTFU)(TOTBr_2) \quad (2)$$

Where,

$$TOTFU = (HFU^+) + (FU^o) + (FU^-)$$

$$TOTCl_2 = (Cl_2) + (HOCl) + (OCl^-)$$

$$TOTBr_2 = (Br_2) + (HOBr) + (OBr^-)$$

For the chlorination reaction, the main governing equations are reaction 4-7. The forward and reverse reaction of the possible reactions are compiled in one term  $k_{app}$  (apparent rate constant of the reaction) that is dependent on equilibrium rate constant for each reaction and the activity of each constituents. The  $k_{app}$  can be obtained experimentally from the trend of 5-FU concentration at increasing pH. The derivations are shown below.

$$K_{app} = k_1\{HFU^+\}\{Cl_2\} + k_2\{HFU^+\}\{HOCl\} + k_3\{HFU^+\}\{OCl^-\} + k_4\{FU^o\}\{Cl_2\} \\ + k_5\{FU^o\}\{HOCl\} + k_6\{FU^o\}\{OCl^-\} + k_7\{FU^-\}\{Cl_2\} + k_8\{FU^-\}\{HOCl\} \\ + k_9\{FU^-\}\{OCl^-\}$$

$$K_1^{FU} = \frac{\{FU^o\}\{H^+\}}{\{HFU^+\}} = \frac{(FU^o)(10^{-pH})}{\gamma_{HFU^+}(HFU^+)} \\ K_2^{FU} = \frac{\{FU^-\}\{H^+\}}{\{FU^o\}} = \frac{\gamma_{FU^-}(FU^-)(10^{-pH})}{(FU^o)} \\ K_{3,Cl} = \frac{\gamma_{HOCl}(HOCl) + \{H^+\} + \gamma_{Cl^-}(Cl^-)}{\gamma_{Cl_2}(Cl_2)} \\ K_{4,HOCl} = \frac{\{OCl^-\}\{H^+\}}{\{HOCl\}} \\ K_{5,Cl_3} = \frac{\{Cl_3^-\}}{\{Cl_2\}\{Cl^-\}} \\ K_{6,Br} = \frac{\gamma_{HOBr}(HOBr) + \{H^+\} + \gamma_{Br^-}(Br^-)}{\gamma_{Br_2}(Br_2)} \\ K_{7,HOBr} = \frac{\{OBr^-\}\{H^+\}}{\{HOBr\}}$$

The derived reaction constants  $k_i$  above are only based on concentration with corresponding activity coefficient of moieties and pH. Activity coefficients of each ion can be calculated using Davies equation shown in equation 3 below. All of the known contributing ions from compound used were taken into account in the calculation of  $\gamma_i$ . As activity coefficient only depend on charge, same charge ( $\pm z$ ) will have the same  $\gamma$  and zero charged compounds have  $\gamma=0$ .

$$\text{Log}\gamma = -0.5z^2 \left( \frac{I^{0.5}}{1+I^{0.5}} - 0.2I \right) \quad (3)$$

Substituting derivation above, the concentration of respective 5-FU form is obtained as derived below. Chlorine and bromine total concentration also obtained with similar derivation. The overall apparent kinetic rate of the equation is as a function of  $HFU^+$ ,  $FU^o$ ,  $FU^-$ ,  $HOCl$ ,  $OCl^-$ ,  $HOBr$ , and  $OBr^-$ .

$$TOTFU = \frac{(FU^o)(10^{-pH})}{\gamma_1(K_1^{FU})} + (FU^o) + \frac{(K_2^{FU})(FU^o)}{\gamma_{FU^-}(10^{-pH})}$$

$$(FU^o) = \frac{TOTFU}{\frac{(10^{-pH})}{\gamma_1(K_1^{FU})} + 1 + \frac{(K_2^{FU})}{\gamma_1(10^{-pH})}}$$

$$(HFU^+) = \frac{TOTFU}{1 + \frac{1(K_1^{FU})}{(10^{-pH})} + \frac{(K_1^{FU})(K_2^{FU})}{\gamma_1(10^{-pH})}}$$

$$K_{app} = k_1(H5FU^+)(Cl_2) + k_2(H5FU^+)(HOCl) + k_3(H5FU^+)(OCl^-) + k_4(5FU^o)(Cl_2) + k_5(5FU^o)(HOCl) + k_6(5FU^o)(OCl^-) + k_7(5FU^-)(Cl_2) + k_8(5FU^-)(HOCl) + k_9(5FU^-)(OCl^-) \quad (13)$$

From the derivation of  $k_{app}$  equation and experimental values, the fitted model is then developed using equation 13. The values of  $k_1$ - $k_9$  were optimized to obtain better fitted model to predict 5-FU behavior under different chlorine and bromine concentration. The results of the fitting model are shown in Figure 33 in the text.