

Designing for Disassembly in the
Built Environment

William G. Wheaton

A thesis submitted in partial
fulfillment of the requirements for
the degree of

Master of Architecture

University of Washington
2017

Committee:
Gundula Proksch
David Miller

Program Authorized to Offer
Degree:
Architecture

©Copyright 2017
William G. Wheaton

University of Washington
ABSTRACT

Designing for Disassembly in the Built Environment

William G. Wheaton

Co-Chairs of the Supervisory Committee:
Professor David Miller
Associate Professor Gundula Proksch
Department of Architecture

This thesis explores opportunities for extending the life of a building and its components through Design for Disassembly (DfD). Our current way of constructing the built environment is “fixed” and difficult to change. This means that most buildings, once a critical function or building system fails, will be demolished. The pervasive idea that “buildings are built to last” has led our culture into a dangerous bind. On the one hand, aiming to design resilience, and on the other, facing demolition based on factors both internal (of the building) and external (of the system). The system we design in is, at its greatest extents, the Earth - we live in a “closed loop.” Beyond solar income, meteors, and cosmic dust, nothing enters or exits this system.^[20] It is finite. On this premise, this thesis develops a methodology for transitioning to a culture of building design that considers the life cycle of a building and its components, stretching beyond its primary manufacture and first use. Even at 50 years, a building becoming “obsolete” and “disposed of” is myopic and wasteful. Most importantly, the viewpoint is at odds with what the scientific community understands to be the only way to avert environmental catastrophe, like the loss of critical resources and functioning of ecosystems.^{[1][22][3]}

Certain building components last longer than others. With this in mind, we must consider disassembly at multiple scales - whole buildings, assemblies, and components. Observing these scales, this thesis investigates different DfD approaches in buildings with anticipated obsolescence of function, in resilient buildings for furthering disassembly as a viable construction approach, and in structures that seek to last “forever.” The “kit-of-parts” approach to DfD is the most pervasive, but it inherently locks certain components and assemblies into a single “product system” - we could quickly end up with a huge inventory of idiosyncratic building kits that have missing parts. Instead, this thesis argues that the network of reclaimed building materials must be saturated with standard, interchangeable components, and that the allocation and redistribution system is crucial to the successful implementation of this proposal.

PREFACE

With a background in industrial design, this thesis began to congeal years ago amidst the frustration with being stuck between plastic-based product design and environmental sciences. As it became clear that I would not contribute to an industry resting on the merits of “built-in-obsolence” and the insatiable appetite for material things, I discovered the degree to which our built environment is a similar manifestation of our culture. The difference is time and scale - products turn over yearly, while buildings turn over in 20-60 years. Although there are many millions of products produced for every building, far more waste is generated by construction activities. After reading William McDonough and Michael Braungart’s first book, *Cradle to Cradle: Remaking The Way We Make Things*, I was moved to seek out a career that influenced as much material as possible. Credit is due to the authors of this book for my career change from industrial design to architecture, and ultimately the thinking behind this thesis.

I would like to thank a number of practitioners who have given me insights and perspective that have been invaluable in understanding the subject. Bill Franklin and David Miller, the architects of the South Lake Union Discovery Center (SLUDC), Hamilton Hazelhurst of Vulcan Developers and project manager for the SLUDC, Jay Taylor of MKA Engineering and lead engineer on the SLUDC, and Bill DeJarlais of GLY Construction and project manager for the SLUDC. These interviews were crucial for understanding the coordination, design, and future of the SLUDC. Thank you to Jeffery Ochsner, who has encouraged me to understand a different side of disassembly - the preservation perspective, and to Ron Wright, architect during the 2002 restoration of the Pioneer Square Pergola, whose interview was helpful in understanding the complexities of preservation work, and its trend toward flexibility. I would like to thank Rick Osterhout of Sustainable Living Innovations for giving me a tour of the 47+7 building, a prefabricated high-efficiency apartment building in the University District. Joseph David, whose work on the Bullitt Center and abstract thinking about this topic helped to seed new ideas. A special thanks to Louisa Larocci, David Miller, and Gundula Proksch, whose guidance through this process has helped me to understand the question with greater clarity. Finally, I thank my Family, and my dog Agassi - With their support and influence, I strive to design with care, love, and conviction.

DESIGNING FOR DISASSEMBLY IN THE BUILT ENVIRONMENT

DFD RESOURCE MANAGEMENT HEADQUARTERS
ANTICIPATING EVOLUTION IN THE INTERBAY DISTRICT, SEATTLE

WILL WHEATON

DESIGN FOR DISASSEMBLY

TABLE OF CONTENTS	Page Number
ABSTRACT	iii
PREFACE	iv
ABBREVIATIONS	x
CHAPTER 1: INTRODUCTION	1-7
THE ISSUE: Fundamental problem with manufacturing Culture	3
POSITION: DfD is a necessary step towards sustainable industry	4
PROPOSAL: Resource Management HQ for DfD in the Built Environment	7
CHAPTER 2: FRAMEWORK	8-62
THE ISSUE Life Cycle Analysis Embodied Energy Sourcing Materials Demolition, Disposal, and Waste Compositions Defining: Recycling, Upcycling, Downcycling Biological and Technical Nutrients	8
POSITION Closing “The” Loop Working within a System Reimagining the System: Economics and Policy Reimagining the System: End of Life (EoL) At Different Scales The “Cadence” of Construction The Fallacy of Project Completion	24

	Page Number
Cumulative Costs of a Building	
Design for Disassembly	
Waste Transition Proposal	
CASE STUDIES	38
South Lake Union Discovery Center : Miller Hull	
Pioneer Square Pergola : Seidelhuber Iron and Steel Works	
'De Fire Styrelser' : 3XN	
CHAPTER 3: METHODOLOGY	63-81
THESIS GOALS AND OBJECTIVES	63
Thesis Statement	
Envisioning an Alternative to Demolition Through Design	
SITE SELECTION AND ANALYSIS	67
Anticipating Development on a Large Scale	
Informing Industry at Fisherman's Terminal	
PROGRAM OF SPACES	68
DfD-BE Resource Management Headquarters	
Public Space	
Division 1: Resource Management	
Division 2: Testing, Grading, Certification	
Division 3: Knowledge Database	
Division 4: Research and Development	
METHODOLOGY CONCLUSIONS	74
INITIAL CONCEPT SKETCHES	76
Interbay Site	
Interior Flexibility	
Sectional Arrangement	
CHAPTER 4: DESIGN PROPOSAL	82-117
NET SHED ANALYSIS AND END OF LIFE	82
Deconstruction From the Top, Down	
EXAMINING THE OLD	84
Roof	
Shell	
Structure	
Foundation	
ASSEMBLY STRATEGIES	88

	Page Number
Basic DfD Strategies	
Proposed Assembly Strategies	
REUSE APPLICATIONS	92
Mezzanine Floors	
Column Assembly	
Stair Tread Assembly	
Facade Assembly	
PROGRAM AND SPATIAL DESIGN	103
ILLUSTRATING DfD	112
Exterior: Facade Replacement	
Entry: Reimagining Foundation Systems	
Office Interior: Mechanical Systems	
 CHAPTER 5: CONCLUSIONS AND RECOMMENDATIONS	 118-121
REPURPOSING AND ANTICIPATING THE OBSOLETE	118
 REFERENCES	 122
LIST OF FIGURES	123
APPENDICES	124-131

University of Washington

University of Washington

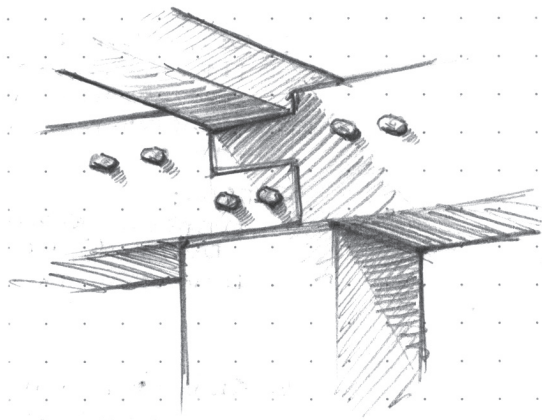

Figure 1. Timber joinery with treenails.

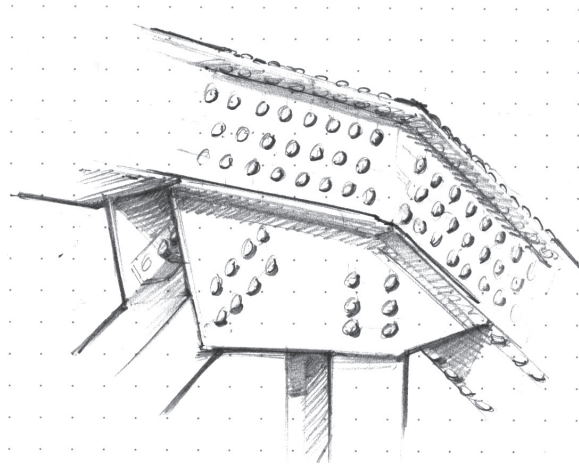

Figure 2. Riveted steel connection.

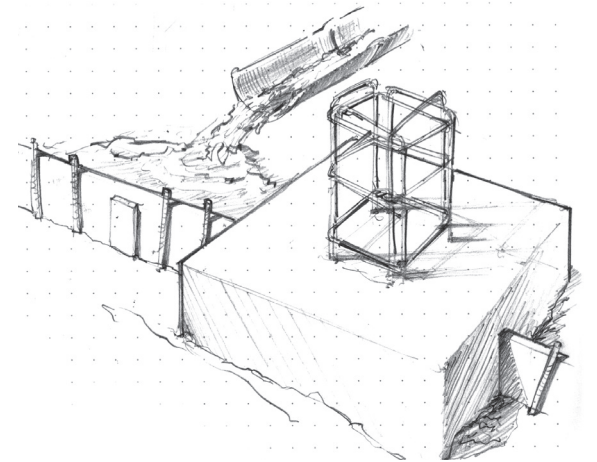

Figure 3. Concrete slab poured around footing.

ACRONYMS, ABBREVIATIONS

DfD - Design for Disassembly

LCA - Life Cycle Analysis

EoL - End of Life

C&D - Construction and Demolition

DCW - Demolition and Construction

Waste

LEED - Leadership in Energy and
Environmental Design

LBC - Living Building Challenge

PSS - Product-Service Systems

DOT - Department of Transportation

MEP - Mechanical, Electrical, and
Plumbing

SLR - Sea Level Rise



Figure 4. Building Demolition

CHAPTER 1

INTRODUCTION

"The conventional way of construction has become a burden to the dynamic and changing society of the 21st century. Developers and real estate managers warn that there is a miss-match between the existing building stock and changing demands with respect to the use of buildings. A report by the World Resource Institute projects 300% rise in material use as world population and economic activity increases over the next 50 years. On the other hand, raw materials are gradually diminishing and becoming expensive, landfill sites are filling up and waste disposal fees are increasing. Dismantling, reconfiguring and transforming of buildings can improve the total life cycle performance of the building. Dr. Durmisevic proposes new ways of bridging the current gap between demolition and disassembly. Durmisevic indicates that Dynamic changes in use of buildings coupled with growing issues related to effective use of materials in construction will require fundamentally different way of design and construction in the future. Durmisevic's vision is one in which homes become extensively transformable, and disassembly and reconfiguration is possible at all construction levels, spatial as well as material"

- Design for Disassembly a key to Life Cycle Design of buildings and Building products, by Elma Durmisevic, Mar 18, 2010

William McDonough, co-author of *Cradle to Cradle* and *The Upcycle*, believes that **“Design is the first signal of human intention,”**^[21] as he states at the 2005 TED conference: “Inspired by Nature.” He goes on to ask, “What is our intention as a species?” Under that premise, McDonough goes on to suggest “first questions” on how we design, from a couple different perspectives. From the “Guardian” perspective, the question is “How can we secure local society, create world peace, and save the environment?” From the “Commerce” perspective, the question is “How do we create prosperity?” His question from a design perspective, which remains independent of the other two, is “How do we love all the children of all species for all time?”

LIFE CYCLE OF A BUILDING: CRADLE TO GRAVE

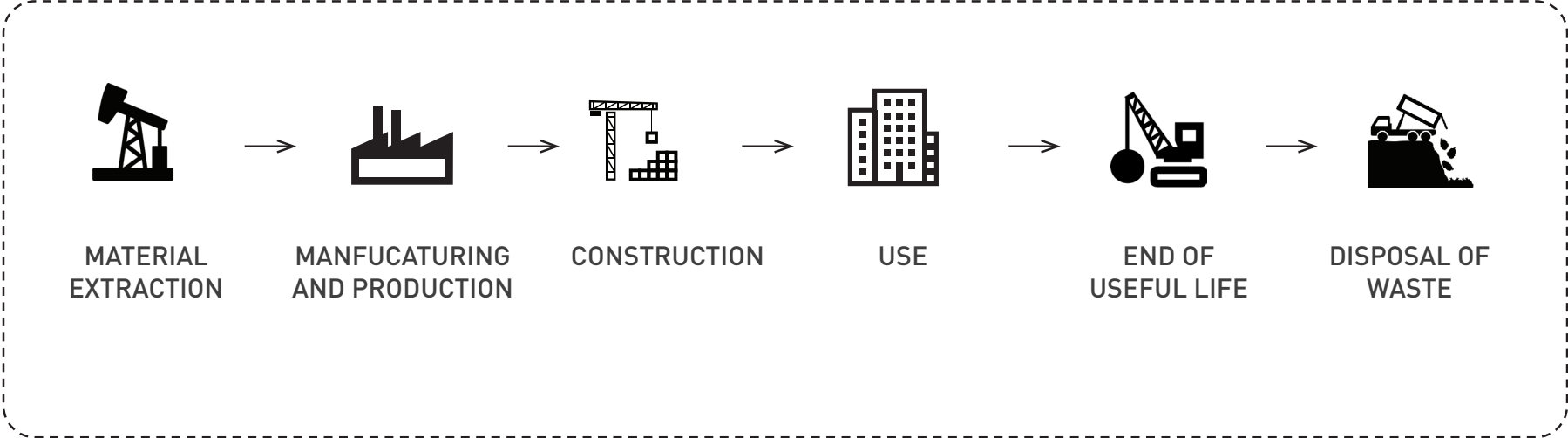

Figure 5. Simplified illustration of how a building's materials currently are extracted, used, and discarded.

THE ISSUE

FUNDAMENTAL PROBLEM WITH MANUFACTURING CULTURE

Anticipating change in architecture is nothing novel. Architects try to imagine and design for life in a building, often overshooting their ability to predict the future through over prescribed program and building functionality. Change is inevitable but the form it takes is completely unpredictable. These two opposing conditions lead us to grapple with uncertainty when designing for change. While architects attempt to design the life (in) a building, it is less frequent that attention is given to the life (of) a building. We must start to frame the problem with the most apparent consequences of our myopic construction methodologies, and work our way backwards to the underlying issues.

Perhaps the most significant construction problem we face in a carbon emission-conscious world is the volume of landfill-bound construction waste. “In the U.S., 160 million tons of Construction and Demolition (C&D) waste is generated annually. This amount represents a third of the total solid waste stream. In the year of 2000, demolition was responsible for 90% of all C&D waste.”^[3] Reports from a conference in the same year suggests that demolition accounts for 92% of construction waste in the Netherlands after close tracking of their materials streams. ^{[1][18]} If we assume that waste accumulates at a consistent rate during work on a building, between new construction, renovations, and general maintenance, and that the EoL phase of a building’s life (demolition) accounts for over 90% of the C&D waste stream, then we understand that the average building is “fixed.” The building is so unadaptable that it is easier to demolish than to repair.

We use our buildings like we use plastic products. They can be described by that word applied mid-century to the majority of material goods produced - “disposable.” This could be the most irresponsible reappropriation of a word in human civilization, and the one with the greatest popular involvement. We have allowed ourselves to be convinced that the world is big enough to disseminate, dissolve, dilute, and incinerate our natural and synthetic materials. Increasing populations intensify this strain.

Among those trends are the nature of industrial processes, entrenched in a past that was pioneered only a century ago during the industrial revolution. Processes that were developed during this time have not been replaced, but the time to do it is approaching fast and with chilling consequences. Assuming the overwhelming majority of scientific projections are true, while they vary in their conclusions, our global population must curb carbon emissions so the Earth's global temperature stops rising. As an industry, we carry a significant environmental burden, and we must be influential in the multi-tiered battle against climate-change-inducing activities.

POSITION

DFD IS A NECESSARY STEP TOWARDS SUSTAINABLE INDUSTRY

Deconstruction is the process of dismantling a structure for the reclamation of some or all its materials. Demolition is the process of completely discarding a building and its materials where nothing is salvaged. Design for Disassembly (DfD) aligns with deconstructibility, giving purpose to materials and assemblies that can easily outlive the life of their buildings and prescribed program. While deconstruction refers to a full dismantling of a structure, designing for disassembly is preemptive and aims to include serviceability and adaptability in its methodology. This allows structures to be reconfigured and reassembled as demanded by changing functions.

Our built environment manifests within a system of resources and constraints. Capitalizing on that system, rather than opposing it, is the way forward. The most imposing regulations we currently face that would encourage DfD are landfill and refuse fees. For DfD to alter the course of material flows throughout the construction industry, a multi-tiered response to the problem is crucial, with a focus on front-end tactics – qualifying and crediting the design of buildings. Currently through accredited programs like LEED, designs are rewarded for their construction waste efficiency, with no credits given for disassemblability. There must also be a significant increase in waste regulations at the buildings end

of life (EoL), especially in cases where partial deconstruction is already viable. When buildings have been designed for disassembly, it will be easier to impose landfill regulations, employ deconstruction crews, and assist manufacturers in their support and exploitation of this new market.

While many structures embody principles of disassembly, adaptability, and separability, the majority of these projects limit their scope of innovative design because it's seemingly impossible to disassemble an entire building for reclamation. There are other designs that grow out of modularity and prefabrication. Often these approaches are "comprehensive" in that they consider the entire building and each of its parts. These are "kit-of-parts" buildings. They are typically designed for assembly, without consideration for their disassembly. On site construction costs are among the biggest considerations in budgeting a project. As a cost-reducer, these methodologies are spot on. They provide direct financial benefit to the developer, and increase efficiency in nearly every aspect of the project. They may benefit future developers for their ease of *demolition*. But their shortfall is that an inherent quality of a modular or prefabricated structure is its ability (or near-ability) to be disassembled, but this aspect is neglected. Because there is no incentive for reverse engineering the building to inform its disassembly, this is only done for temporary structures and those with an anticipated demolition or physical move. The "kit-of-parts" for disassembly approach has been undertaken for small and large-scale projects. This paper investigates some of these approaches, in buildings with anticipated obsolescence of function, in experimental buildings for researching disassembly, and in structures that seek to last "forever." These buildings bridge the divide between permanence and temporality, on the one hand having a designed future that is perpetual, and on the other belonging to a site which will change drastically during their occupation of it.

LIFE CYCLE PROPOSED:CRADLE TO CRADLE

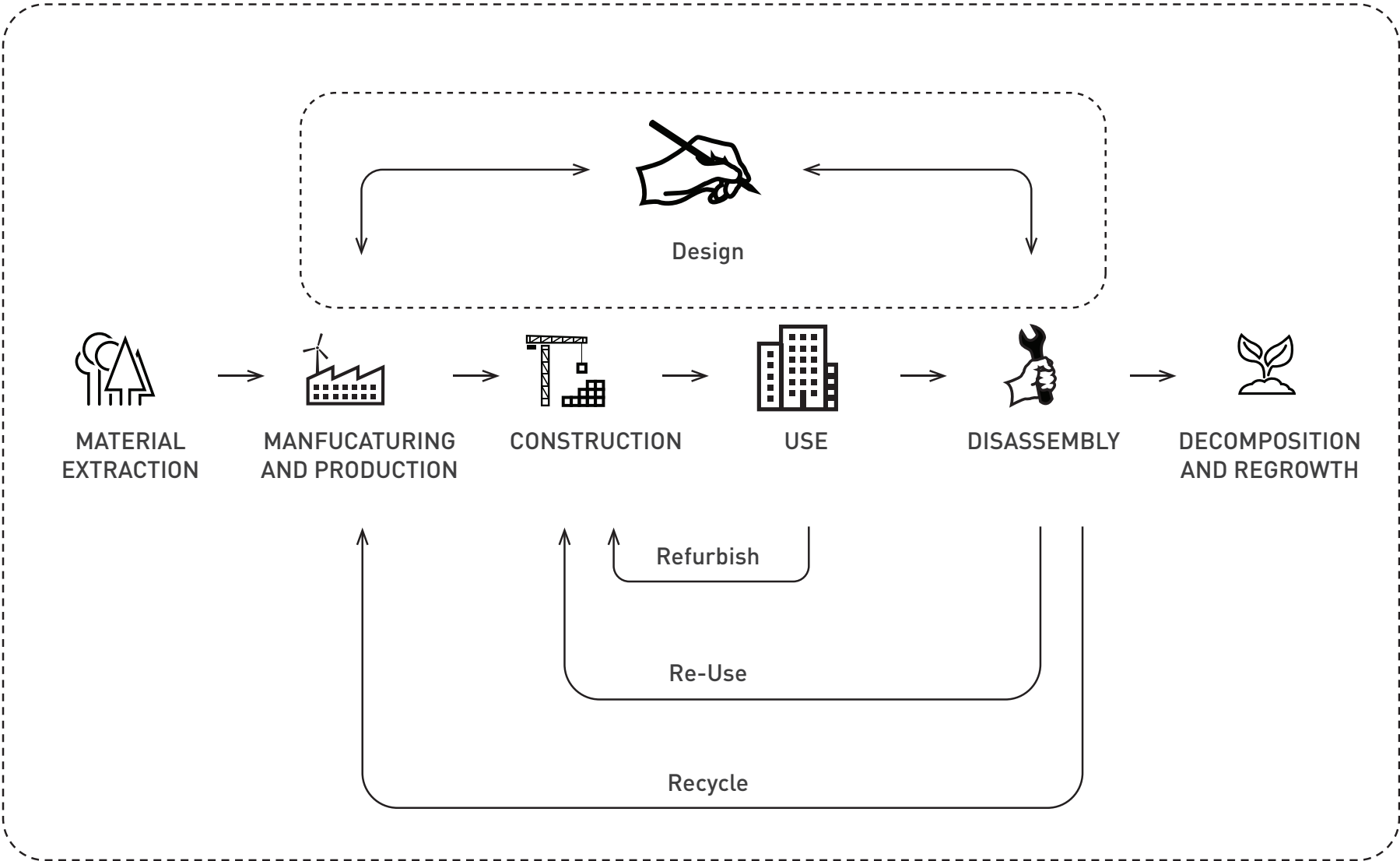

Figure 6. Illustrates a modification to the existing practice, where materials are seen as nutrients in an industrial ecosystem to cycle through infinite recycling, regrowth, and reuse.

PROPOSAL

RESOURCE MANAGEMENT HQ FOR DfD IN THE BUILT ENVIRONMENT FISHERMAN'S TERMINAL, INTERBAY, SEATTLE

Warehouse districts and vacant industrial centers have been attractive to developers for a decades, and continue to be. The opportunities for reuse offered in their large open buildings are testament to the flexibility of industrial space plans versus the highly prescribed architecture of institutional buildings. History shows a trend of warehouse and commercial space conversion and adaptation, while institutional buildings are locked into their functions.^[15] Schools, libraries, and hospitals all tend to perpetuate their original function to the point of obsolescence, at which time the building is torn down (in rare cases converted to a historic landmark/museum) because the cost of conversion to another function is too high.

The project identifies the Interbay district in Seattle as an area that is teeming with developer interest. The Port is the largest landowner of properties in the Interbay, with Fisherman's Terminal among them. In a hypothetical condition, a policy mandates that new buildings constructed in the sea level plane must be designed for disassembly. Sea Level Rise (SLR) threatens the Interbay with projections showing partial submersion in 2100. A deconstruction plan aims to salvage materials from the many buildings deemed doomed by SLR, rather than traditional demolition.

Designed in part with materials from the underutilized Fisherman's Terminal Net Sheds, a new commercial will be constructed in an adjacent site. The materials recovered will illuminate the wealth of resources in our existing building stock. By designing this new building for disassembly, the proposal illustrates that even with reclaimed materials, the simple principles of DfD can inform all construction.

CHAPTER 2

FRAMEWORK

THE ISSUE: FUNDAMENTAL PROBLEM WITH MANUFACTURING CULTURE LIFE CYCLE ANALYSIS (LCA)

Life Cycle Analysis of Life Cycle Assessment (LCA), “Is a standardized method of tracking and reporting the environmental impacts of a product or process throughout its full life cycle (ISO, 2006a: 8). Originally developed from the principles of industrial ecology and first applied to the manufacturing of products within a factory, LCA methods and data are used...to assess a whole building from construction to end of life.”^[22] There are different models used under the LCA umbrella. The work of Kathrina Simonen, author of Life Cycle Assessment, focuses on developing a universally accepted methodology in LCA and on the establishment of a system for vetting products and materials and archiving that knowledge in a database.

Emissions to nature and extractions from nature are the main quantities tracked in the LCA system.^[22] They must be straightforward to quantify and measure, such as impacts from fuel combustion, and as opposed to impacts like habitat disruption. A simplified version of the life cycle stages of a building can be seen in Figure 5.

EMBODIED ENERGY

The energy embodied in a material is the amount of energy used to produce or manufacture a product, including energy required to produce the infrastructure for material extraction and manufacturing, the indirect energy used for material extraction and transportation, and the direct energy used to manufacture a product.^[22] Without comprehensive embodied energy data, most estimations for embodied energy put the average impact at 30-50% of a building's total life cycle energy.^{[1][22]} In other words, a building that lasts 50 years would have to heat/cool/operate the building for between 15 and 25 years before the operational energy required equals the building's embodied energy.^[1] A study undertaken in Vancouver and Toronto, Canada, shows this ratio of "Embodied energy in terms of heating energy," concluding that in both cities, high efficiency buildings with lower operating energy inputs, effectively position the embodied impact to be proportionally higher - in the case of these Canadian cities, embodied energy doubles in relation to operational energy.^[1]

Numbers are also based on building design that has not even begun to establish reuse guidelines - these are high efficiency buildings, focused on operational energy reduction and not DfD or reclamation. As we continue to reduce operational energy through clean energy, which is currently the low-hanging fruit in building efficiency, an optimistic perspective is that the embodied energy problem will surface as the most environmentally detrimental. This thesis focuses on an embodied energy approach rather than the operational energy efficient building model, an area of research and development already advancing rapidly.

SOURCING MATERIALS

The United States sources most of its main construction materials from other countries^[40] as the world map shows. We import far more than we export, a portion of those materials are raw, and some are manufactured products. For a number of economic, political, and social reasons, we maintain strong trade ties with other countries through commodities like building materials. The bigger picture reveals the system's issues. Because the U.S. sources materials from around the world, and uses them a single time before selling them back at a significantly lower

FOUR COMMON MATERIAL IMPORTS

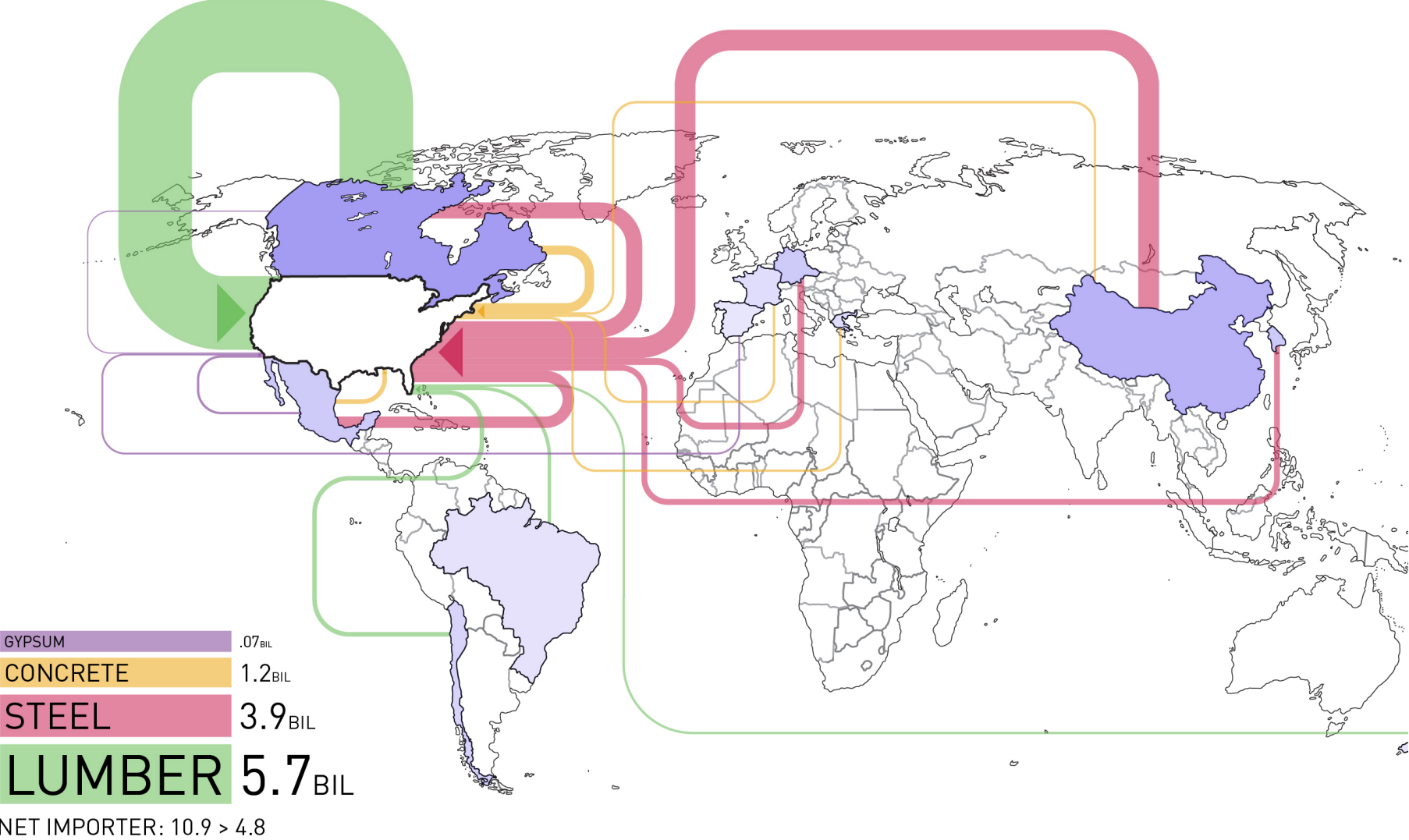

Figure 7. Diagramming the flow of materials from around the world into the United States.

value, discussed below, the embodied energy rises dramatically due to the energy cost in transport. Large steel components are smelted and reformed at high temperatures, and quality is lost by the mixing of different grades of steel. We often buy those same materials back in a different form, transporting them overseas or borders once again.

DEMOLITION, DISPOSAL, AND WASTE COMPOSITIONS

U.S. Demolition accounts for 92% of Demolition and Construction Waste (DCW).^[18] A look at demolition processes is helpful to understand the current limitations of equipment and material recycling. The process can be separated into two stages, and the end goal is to separate the materials into three streams - recyclable, burnable, and non-burnable^[1]. Stage one involves stripping the building, first of its reusable components which typically consist of the following: glass elements removed from window frames, sanitary fixtures, wooden floor finishes, and radiators^[1]. Stage one finishes with the stripping of plasterwork, service installations, pipes and roof coverings. Flat roofs are taken to the landfill, and roof rocks are treated as contaminated chemical waste. Stage two, once the stripping is complete, the structural demolition continues with large machinery using breaker shears, cranes and equalizer beams, and explosives to reduce structural section sizes. Materials are transported to a processing plant where a crusher and large magnet separates steel reinforcement from concrete. Brick is typically broken apart before its mortar, rendering reclaimed bricks largely non-recyclable. Steel beams are disassembled and reused if possible, but typically sent internationally to a steel mill.

Waste Diversion Plan & Deconstruction and Salvage Assessment

Project Number _____

Owner/Contact Name _____ Phone _____

A waste diversion plan is required at application intake for all construction and demolition projects with an area of work greater than 750 square feet. If the project involves demolition, also complete the deconstruction and salvage assessment on page 2. This waste diversion plan must be submitted at application or e-mailed to DPD.Plans_Routing@seattle.gov.

Use the drop-down lists to fill in the columns below

- Next to each potential waste material, indicate if the diversion method will likely be "Reuse", "Salvage Off Site", "Recycle Source Separated", "Recycle Comingled", or "Landfill". Bold cells indicate frequently salvageable/reusable materials.
- If a specific material is diverted in 2 different ways (for example, you might salvage some wood for reuse and then recycle the rest), use the "Wood" category to fill in one way the material was diverted and use the "Other" cell to identify wood and fill in the second way the wood was diverted.
- You may use your own form as long as it identifies material, diversion method, hauler and receiving location.
- Attach additional pages as needed.

Material	Diversion Method	Hauler	Receiving Facility
Individual Materials			
Asphalt Paving *	Choose Selection	Choose Selection	Choose Selection
Asphalt Shingles		Bobby Wolford Trucking and	
Brick (whole)*			
Carpet/padding			
Concrete *			
Cardboard *			
Glass			
Gypsum/Drywall *			
Land Clearing			
Metals *			
Plastics			
Plastic Film Wrap			
Rock/Gravel			
Soil/Sand			
Wood *			
Other:			
Hazardous Waste			
Recyclable Comingled Material			
List materials to be recycled:			
Mixed Non-recyclable Debris			

* These materials should not be disposed in construction site disposal containers and at transfer station disposal areas. For gypsum scrap this landfill disposal ban applies to new gypsum scrap only

Keep a copy of this Waste Diversion Plan to help complete the Waste Diversion Report which should be submitted directly to SPU within 60 days of final inspection approval from Seattle DCI. A copy of the Waste Diversion Report & directions for how to submit it to SPU are found here:

<http://www.seattle.gov/util/ForBusinesses/Construction/CDWasteManagement/RecyclingRequirements/WasteDiversionReport/index.htm>

For technical questions on how to fill out the Waste Diversion Plan, Deconstruction Salvage Assessment, or Report, please contact Seattle Public Utilities at: WasteDiversionReport@seattle.gov

I will submit the Waste Diversion Report after Seattle DCI final inspection approval, as required by SPU

1

Figure 8. Waste Diversion and Salvage Assessment (Above) to be filled out by one of the three companies (Right) to satisfy Seattle's requirement to attempt to reclaim usable architectural elements.

The companies (Figures 9, 10, and 11) are cluttered, full of dissimilar parts and, while full of unique and subjectively valuable items, do not contain quantitative value.

BALLARD REUSE
"A junkers paradise"



SECOND USE BUILDING MATERIALS
"Eclectic variety of gently (and not-so-gently) used building materials."



EARTHWISE ARCHITECTURAL SALVAGE
"Cool stuff. Terrible pricing."



C&D TRANSFER STATION SORTING



Figure 12. An unburnable waste stream (Right, Above) will be sent to the landfill.

Figure 13. A burnable waste stream (Right, Below) will be sold at a low cost to be burnt as fuel.

DCW GENERATED DURING:

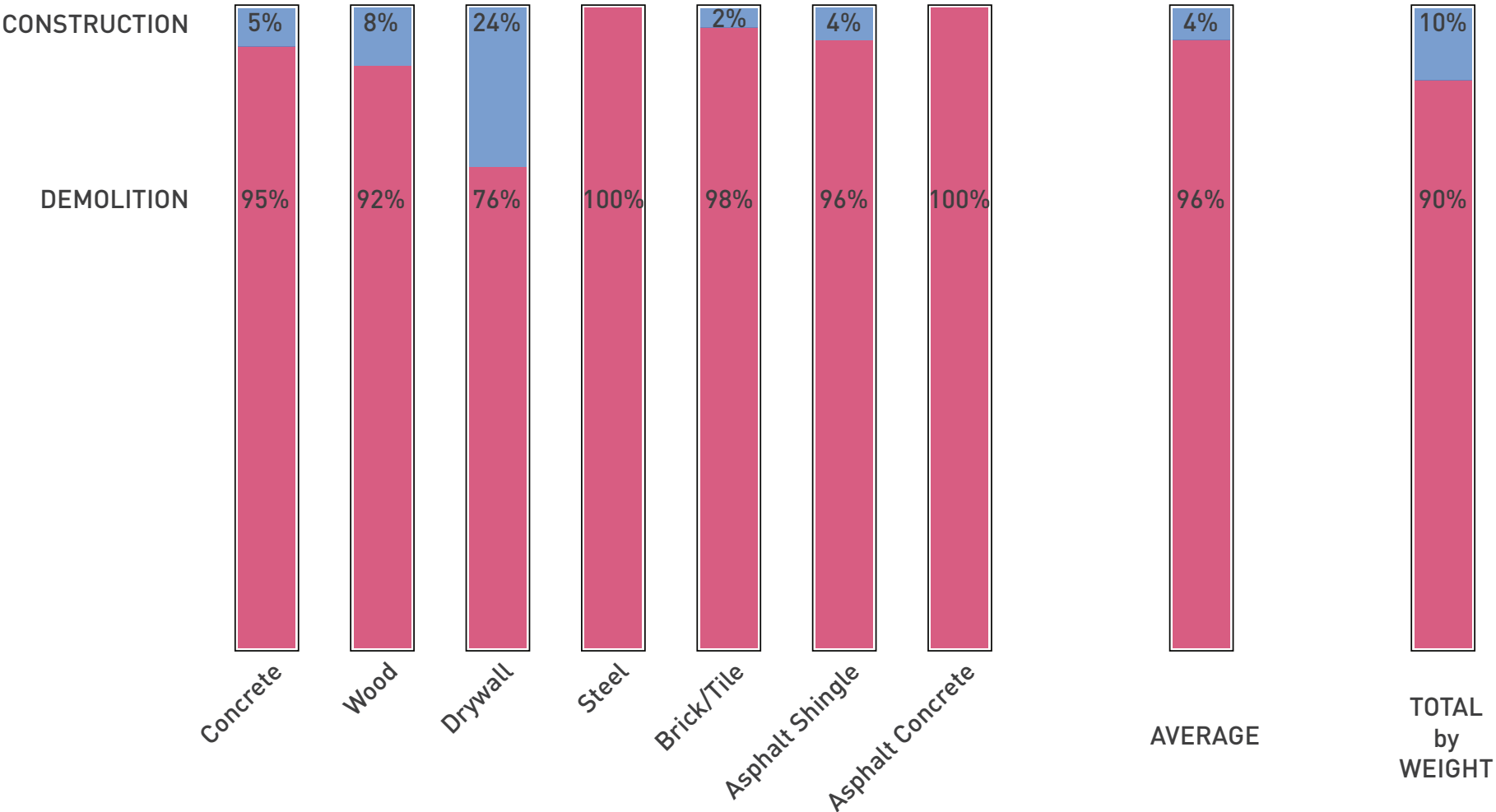

Figure 14. Illustrates when in a building's life waste is generated. 90% of waste is generated during demolition - this can be reduced by the ability to reclaim materials at a building's EOL. Waste generated during construction can be reduced by prefabrication (as in steel components) or by the ability to utilize all excess (as in asphalt concrete) where the extra is added back to the mixture.

WASTE VOLUME BY MATERIAL DENSITIES

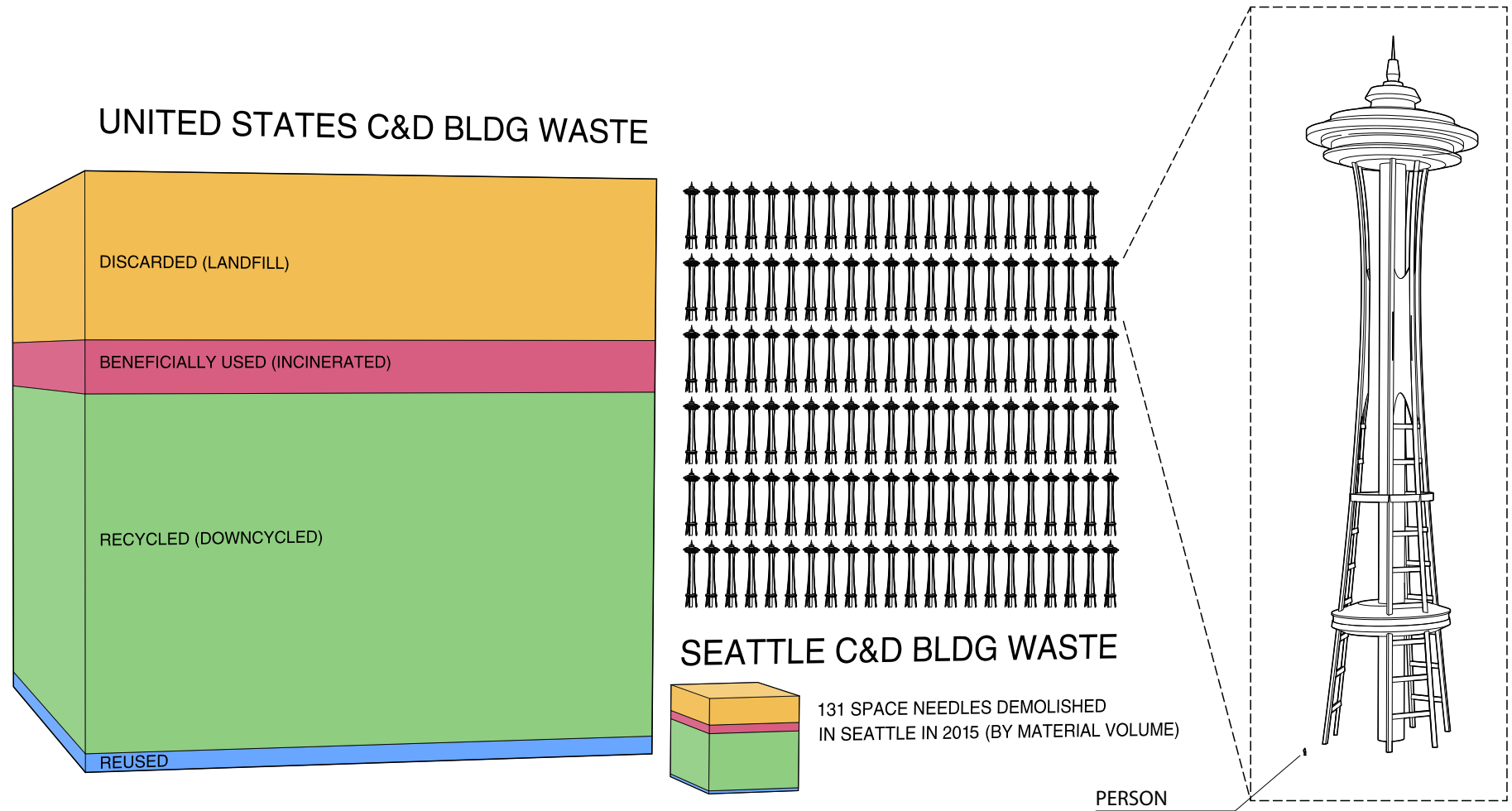

Figure 15. visually compares the material volume of DCW in Seattle and the U.S. Based on material densities, Seattle demolished the equivalent of 131 space needles were demolished in 2015.

SEATTLE'S DCW: WHERE IT GOES

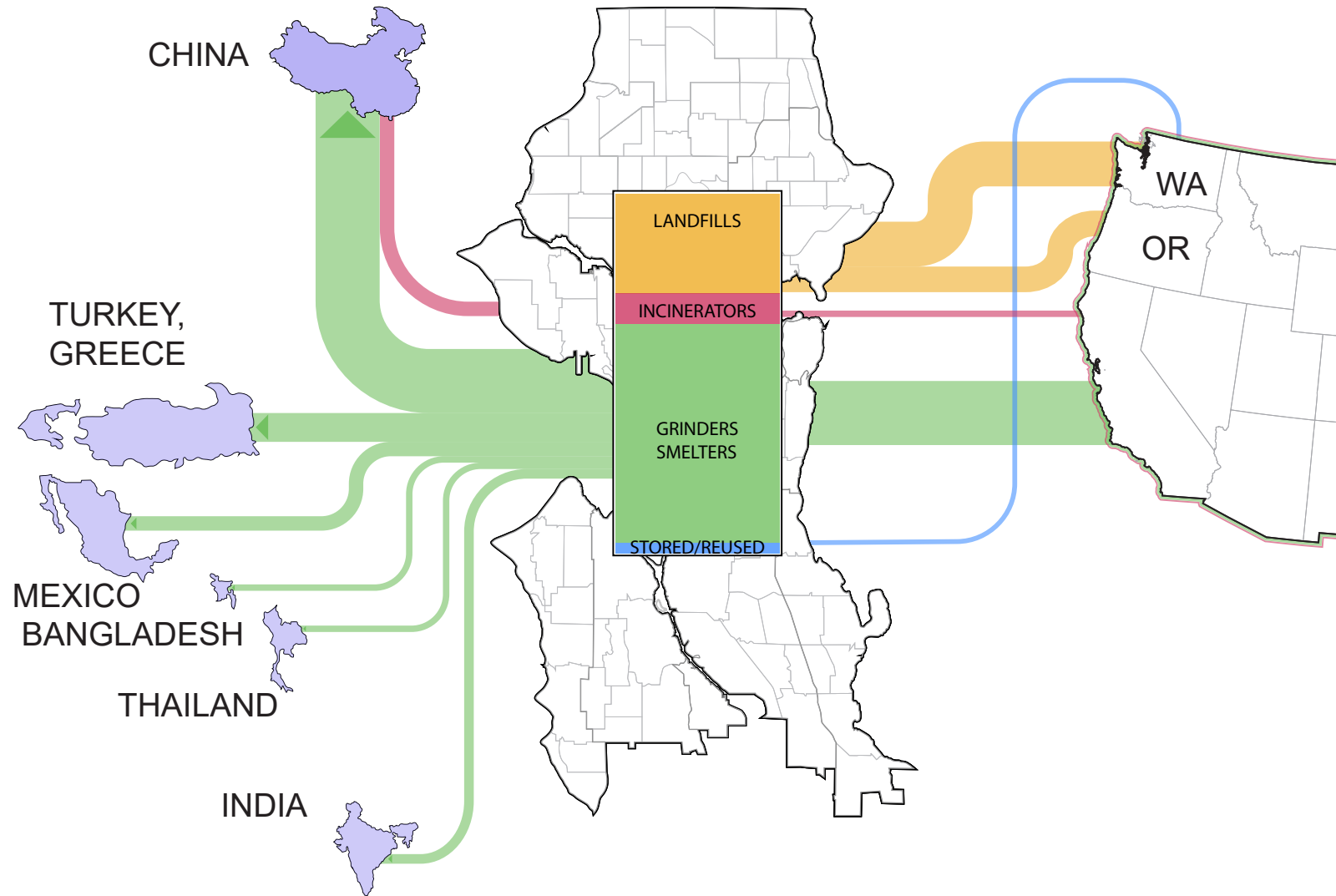

Figure 16. maps the disposal and sale of materials after demolition. Landfill garbage stays local (mostly Eastern Washington and Eastern Oregon landfills) and the portion of recycled material remaining in the U.S. is almost exclusively crushed concrete. The majority of all materials with any resale value are sent internationally.

DCW COMPOSITIONS

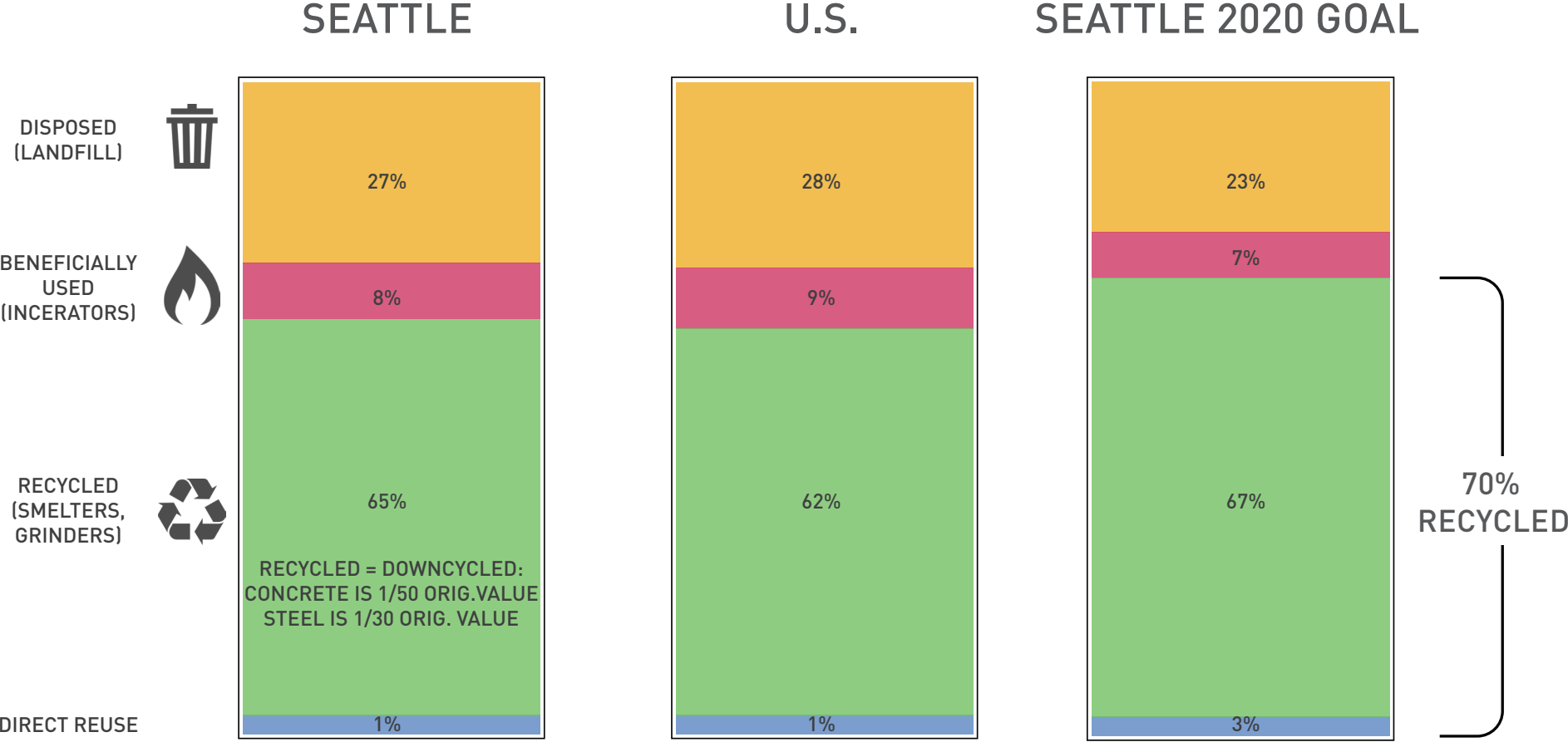

Figure 17. shows waste compositions for Seattle and the United States, based on data collected at transfer stations by the Environmental Protection Agency (EPA). Seattle’s goal for 2020 (established in 2012) aims to increase waste recycling to 70%.

DEFINING: RECYCLING, UPCYCLING, DOWNCYCLING

Recycling is used to loosely describe the reuse of materials, in a manner that closes the material loop so products aren't "disposed of" after their first use. It follows that, the reductive but common understanding is, the more times a product's material is reused, the better it is for the environment - this is not always true. We can discuss recycling in terms of material "loops," or as a function of "up" or "down-cycling." The "loops" definitions routinely introduce assumptions and confusion. Closed loops refer to when "materials from a product system are recycled into the same product system."^[23] A common fallacy is that "closed loops" are inherently better than "single," or "open-loops," where multiple product systems are involved. In many cases across industries, the introduction of the material into a second stream is more beneficial than keeping it in the same product system. For example, lubricant oil, a product where used oil can be re-refined into secondary lubricant oil, or alternatively combusted as fuel (marking introduction into its second product system.) The demand for lubricant oil is greater than the supply, indicating reuse opportunities, but the process of re-refining the oil is more energy-intensive and has higher GHG emissions than primary extraction, meaning that combusting the used oil as fuel (and extracting virgin oil for lubricant) is of greater environmental value currently than re-refining it.^[23] In this case, the open-loop system is only *less bad* than the closed loop.

Many factors must be considered in each type of recycling, but it is important that we don't make assumptions based on open and closed loops. In the Netherlands, up to 90% of their concrete is recycled.^[1] 20% can be reused for new concrete aggregate, but most of the crushed aggregate is used as road base. Here we have two scenarios - in the first, closed-loop product system, the crushed aggregate returns to be reintroduced as concrete aggregate. In the second, the aggregate enters a new product system, asphalt. Multiple studies show that recycled, crushed aggregate used 37% more energy than virgin aggregate.^[23] In both open and closed-loop product systems, the energy required for reintroducing crushed aggregate is nearly identical, and both systems are environmentally detrimental. Furthermore, contrary to most LCA material, closed and open-loop definitions are not meaningful in themselves. According to the article "Common Misconceptions About Recycling," "it is closed-loop recycling that exacerbates the risk of contaminant buildup, such as copper in steel, iron in aluminum, or flame

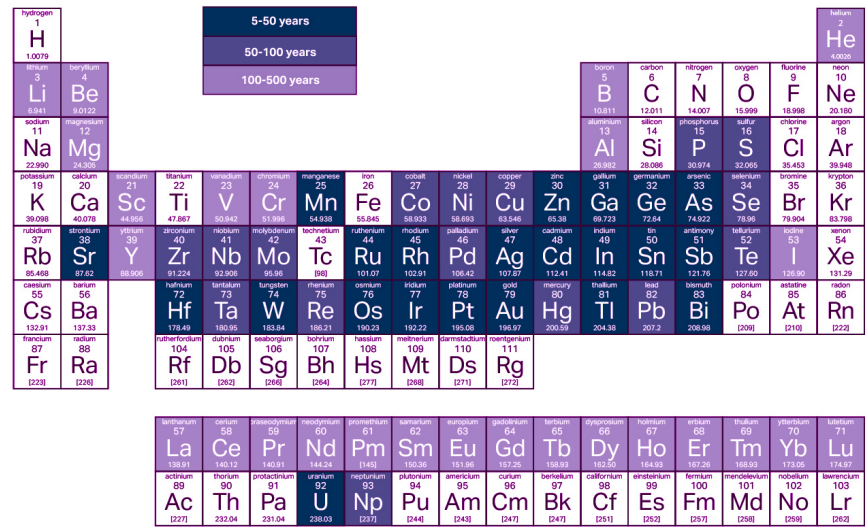

Diagram: Years remaining until depletion of known resources.¹⁶

This diagram is a reinterpretation of an original owned by Ellen MacArthur Foundation

Figure 18. The periodic table (Left, Above) shows years remaining until depletion,^[37] and illustrates that some of our common materials will be either impossible to mine or of such reduced quality that it is not cost-effective. Recycling rates (Left, Below) illustrate in many cases a correlation between scarcity and recycling. Unfortunately, the reality is that much of our recycling is downcycling and reduces

Diagram: Current recycling rates of know ressources.¹⁶

This diagram is a reinterpretation of an original owned by the Ellen MacArthur Foundation

retardants in plastics.”^[23] If these definitions (as principles to follow) are inadequate, we must come to an understanding of recycling that supersedes the economic and material complexities of recycling processes, before evaluating each process and material by case.

Downcycling or “cascading” is used to refer to recycled products that are of lower material quality, performance, or functionality than the original. Upcycling or “creative reuse” is the process of repurposing waste and byproducts into useful materials of a higher quality, performance, or functionality than the original material. Both open and closed-loops will have areas of downcycling and upcycling. Ultimately, the most important factor in recycling is the *displacement* of materials. The net environmental benefit of recycling is actually $D \cdot (E_{\text{prim}} + E_{\text{landfill}}) - E_{\text{repro}}$, with “D” equaling the total displacement from the recycling system, “E_{prim}” is the energy required for primary material manufacture, “E_{landfill}” is the energy required for landfill processing, and “E_{repro}” is the energy required for reprocessing.^[23] When recycling is framed in this way, we look at each product and determine whether the net displacement is in the positive or negative, and classify it as either “upcycling” or “downcycling.” By this definition the ultimate goal is to increase the displacement, in many cases the reprocessing requirement is the critical variable.

BIOLOGICAL AND TECHNICAL NUTRIENTS

Biological nutrients are those materials that are created by the earth and fit within the Earth’s natural cycle of growth and decomposition. Biological nutrients can, according to William McDonough, account for about 500 million people,^[21] suggesting that by this estimation we have exceeded our carrying capacity on biological nutrients alone. “So we need [non-biological] materials in closed loop cycles, but we need to analyze them at a PPM level.” McDonough and German chemist Michael Braungart have spent the past couple decades doing that, and trying to create infinitely recyclable products that don’t off-gass, contain or produce toxins and chemicals which harm animals or environment during their manufacture and recycling. When McDonough and Braungart refer to closed loops, they mean closed at the molecular level, without ANY introduction of foreign compounds that affect recyclability and environmental effects. Importantly, their research goes into great depth in the manufacture of these products, which will be critical for developing an industry of reuse and responsible manufacturing.

CRADLE TO CRADLE

1. **Healthy Materials** in Biological and Technical Metabolisms.
2. **Circular Economy** including quality products and buildings as continuous assets
3. **Clean Energy** and restorative carbon balances.
4. **Clean Water** in production and use cycles.
5. **Social Fairness** and shared abundance.

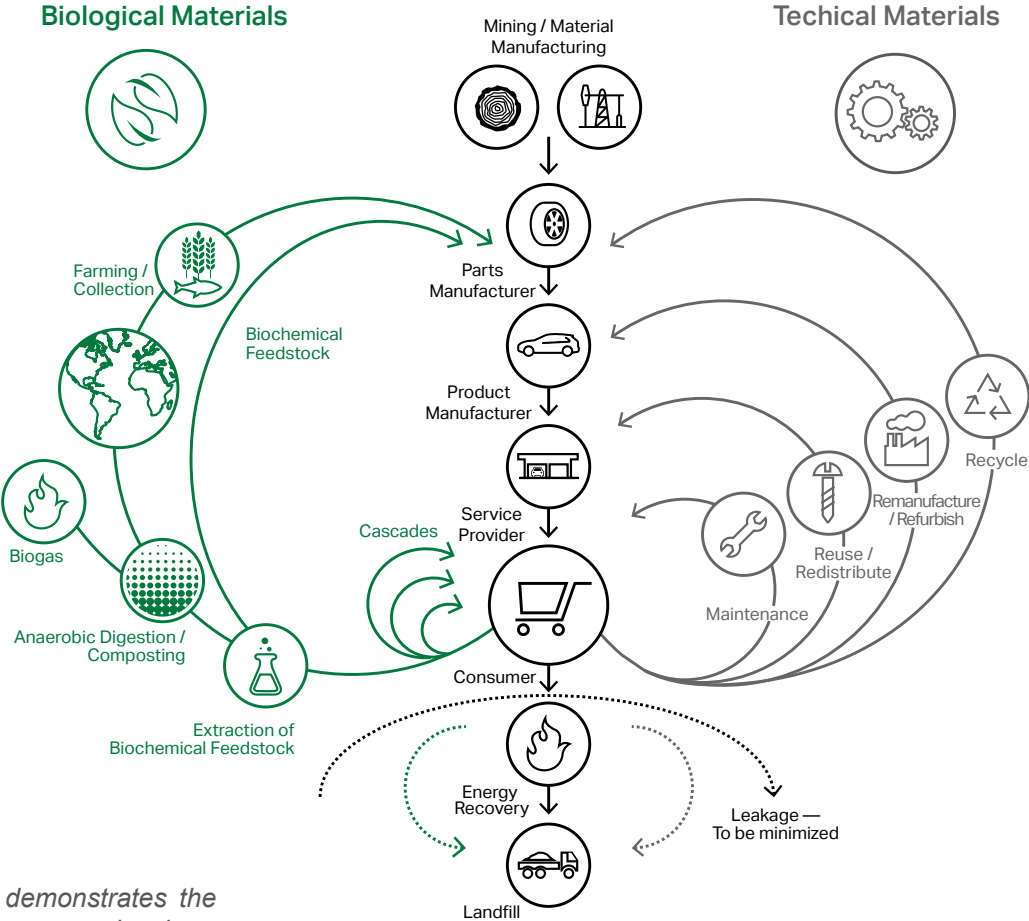

Figure 19. This graphic by 3XN demonstrates the circular nature of a cradle to cradle approach, where at each phase of a product or material's life it is optimized to for recycling or reuse.

This diagram is a reinterpretation of an original owned by the Ellen MacArthur Foundation

When speaking about the elegance of a tree, McDonough asks us to “Imagine this as a design assignment: Design something that creates oxygen, sequesters carbon, fixes nitrogen, distills water, accrues solar energy as fuel, makes complex sugars in food, creates microclimates, changes colors with the seasons, and self-replicates. Why don’t we knock that down and write on it?!”^[21] He goes on to argue that we take this biological dream material and embed it with ink, dyes, and adhesives that are either toxic for the environment, for us, or render the biological nutrient useless after this life-limiting hybridization. William McDonough has an interest bias towards alternative synthetic materials, and is a proponent of developing them towards infinite recyclability. While the tree may fundamentally be mankind’s ultimate building material for its material properties, application flexibility, and for all its ecosystem services, McDonough argues against the way we use it currently - in construction, much like the paper in books, we embed chemicals and other products into wood resulting in a product that must be disposed of or downcycled. Considering the building industry’s strong bias towards steel and concrete, it is more time-sensitive and practical to address the concerns with material extraction, and embodied energy of manufactured composite products than to gradually convince the building industry that the tree is the ideal structural building material. With the understanding that recycling of any of these materials is energy-intensive and nearly or completely negates the product’s value in embodied energy, the research illuminates the absolute necessity of chemical isolation within streams. In other words, any material or chemical that is combined must be done in a way that the release of the bond is non-toxic, that the bond between materials can be released 100%, or that a permanent bond between the materials is more desirable for longevity and retaining embodied energy or carbon.



Figure 20. The Herman Miller Mirra Chair is an example of design for disassembly in product design. It allows for replacement and refurbishment of individual parts, and ensures recyclability of each component. By designing for disassembly, the design is more intuitive and easier to assemble as well.

POSITION

CLOSING “THE” LOOP

LCA literature refers to the “closed loop” strategy by the definition presented earlier, whereby a material remains in the same “product system” after reprocessing. The practicality of actually defining this product system is low - we can define it on a molecular, product, and material application level, and we can arrive at a ven diagram overlap of unlimited complexity. This thesis abandons these definitions at the product level, but will maintain the importance of understanding the “closed loop” at a global and a “systems” level. Except solar income, meteors, (and lest we forget the hole in the ozone and space junk), we operate in a closed system on a global level. It is the singular, global system from which we extract, and within which we manufacture and distribute products. With climate change, it has become clear to the informed global citizens, that we operate within a finite system and that our effect upon it is lasting. Our finite resources are currently used in an inherently dissipative way (such as fuel combustion), or by locking them together as a composite material, both of which preclude any additional cycles and result in dissemination into the biosphere. The understanding of the Earth as a closed-loop system is essential for the “survival” of the environment (in any form similar to as we know it), and for the survival of most of the Earth’s species. The idea of closing the loop will be used in this thesis on a conceptual level, referring to the elimination of emissions and manufactured materials to the biosphere, as a goal. Other loops will be referred to as “streams,” omitting molecular and chemical-level distinctions.

The research in this thesis concludes that upcycling and creative reuse are the avenues of reclamation that carry the greatest net positive environmental impact. The building components are understood as manufactured materials that carry a certain embodied energy - recycling of the material must always remain an option, but is the lowest level of consideration for reclamation. At the top are those processes that allow a building product to swiftly transition from one application to the next with the lowest energy requirement for reprocessing. The variables of greatest importance include network fluidity and material allocation, accessible knowledge databases, and the management of change in construction and urban policy.

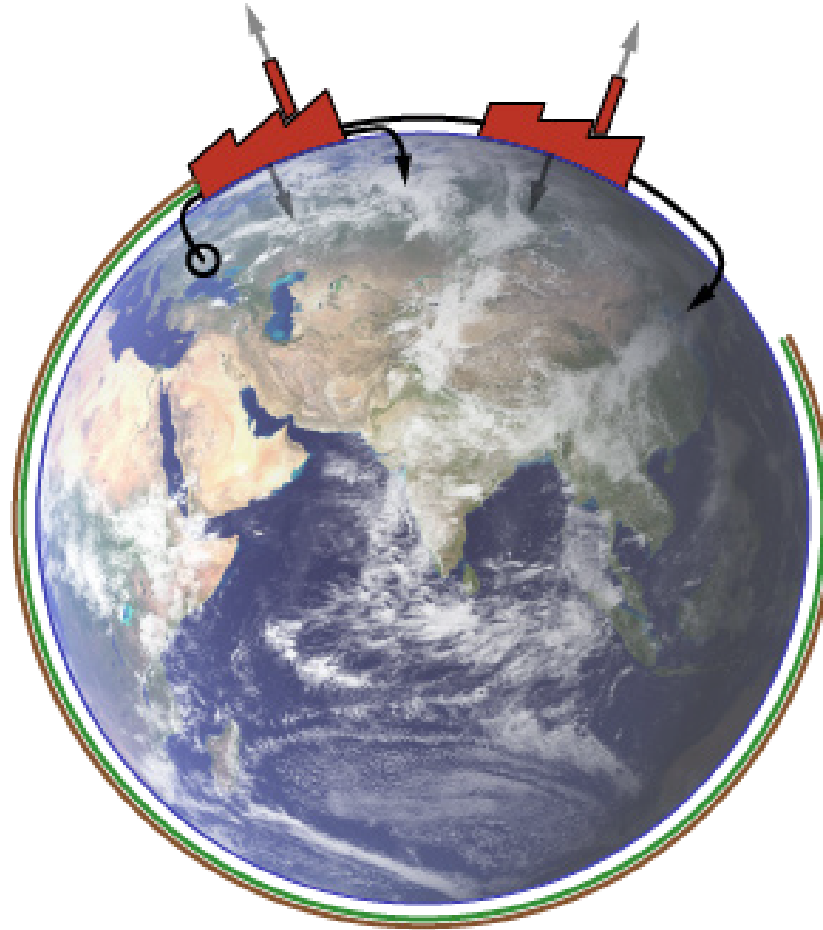

Figure 21. In industry we extract materials, then redeposit them as emissions, toxic byproducts, or waste. The Earth functioned as a closed loop system with natural resource regeneration until we fundamentally altered the use of those resources. The goal is to use resources infinitely in this finite system - infinitely recyclable materials and nutrients can effectively “close the loop.”

WORKING WITHIN A SYSTEM

In *The Upcycle*, McDonough and Braungart make a distinction between what they define as “capital” and “currency.”^[20] Referring to the argument made in Hernando de Soto’s book *The Mystery of Capital: Why Capitalism Triumphs in the West and Fails Everywhere Else*, McDonough defines “capital” as something that is “stored, saved, invested, or embodied for future deployment”^[20] - it does not “flow.” Sunlight is currency. Fossil fuels are capital, used as short-term currency for quick gains. Our material products can become currency if we use them as products that “flow” from one application to the next, and from one physical state to the next (if the energy used for phase change is a “currency” as well.)

“By using the planet’s fossil fuel “life savings,” so to speak, to meet daily energy needs, societies become entrenched more deeply in a system that can’t perpetuate itself. There is no good reason to squander this capital when humans have so many energy resources that are capable of rejuvenation.”

-William McDonough and Michael Braungart, *The Upcycle*

The Earth is a closed loop with an incredible inventory of materials - of course, we do have solar income, which plants use for photosynthesis, thus creating more material. Humans have turned solar income into useful energy, but have not yet figured how to turn light into materials. Our materials are mostly extracted, and manufactured. If we understand manufactured products as finite, and as part of a technical nutrient stream, we begin to value their embodied energy and the potential and absolute necessity for reuse.

The system can be defined as the paradigm, body of entities, and resources that affect, inform, and govern our manufacturing and building industries through time. It is obvious that the boundary for this system could be drawn in an infinite number of ways. The system will work regardless of the complete containment of all components and their reach. For example, embodied energy includes the indirect energy used in material extraction, which in turn includes the energy used for the manufacture of the machinery used in the extraction of the oil used to operate the machinery used to extract and process the raw materials...and so on. As complex as the potential for this layering of embodied

processes is, LCA practitioners are working to develop detailed models of this embodied energy system under a common methodology,^[22] and before long we will be able to assign an approximate value for the embodied energy in each component, and the sum of those components will constitute a whole building LCA. A whole building LCA is the intuitive next step once the system has been populated with information for the majority of building materials.

This thesis proposal uses the following four categories for defining and developing the system in a concentrated manner to facilitate early adoption:

DfD INDUSTRIAL SYSTEM:

- 1) Knowledge database - includes design recommendations, disassembly feedback, material specifications, allocation system
- 2) Infrastructure - Transport systems/constraints
- 3) Operating Policy/Culture - Policy which accepts/accommodates DfD, Anticipate potential policy changes, Exploit social influences
- 4) Private entities - Disassembly crews (mobile), Disassembly processing facilities (fixed/flexible)

REIMAGINING THE SYSTEM - ECONOMICS AND POLICY

Now we face a new series of tests that will challenge our material culture, and our construction policies. DIY is trending now! How far are we from being able to print a house? How quickly will that technology advance, and how quickly could it increase the rate of production to an unsustainable level? (Some argue we are already there.) Either way, with the advent of DIY, public and construction policy must reflect a renewed concern for the resources used and emissions and products disseminated into the environment.

Proposing a reimagining of the construction industry is ultimately an economic question. We are at a major point of conjecture in human history. Despite industry, technology, and globalization growing as rapidly as they have been, we have resisted change in our fundamental approach to many processes. Construction is one of these. Because the turnover for buildings is at a much lower rate than products - building design for

~30 years, product design for ~1 year - we are behind in progress of construction technology compared with digital and industrial technology. An argument can be made that we are both disadvantaged by the lack of repetition and testing prototypes, and we are equally fortunate that we don't have the ability to produce buildings at the same rate as products. If we consider how much construction waste is generated, the speed we would be going through resources if buildings were produced like products, is palpable. The time and resource investment into each building begs far more thought and foresight than the product industry, which is plagued by myopia.

The overall economic potential of an entirely new market, based not on myopic gains but rather on reclamation over long periods of time, has positive implications for nearly every sector of the construction industry. In our current system, our buildings are front-loaded with energy, material, and labor investments. From the minute a building is finished and begins to operate, it is abandoned by the construction community. Serviceability is one of the major advantages of disassemblable buildings, opening the opportunity for utility companies to more easily adapt and upgrade a building's services. If utility companies became more integrated with the MEP contractors who build and service a building, a utility company could sell "The Product of Service" to a building. The idea of the "Product of Service" was described by McDonough and Braungart in their book *Cradle to Cradle*, but has conceptually been in development for decades.

Companies began exploring the idea of "Product-Service Systems" (PSS) in the 1990's, but a few companies, most of them in the technology sector, began looking at a service model to increase profits earlier still.^[25] In the building sector, one of the most obvious opportunities for PSS is in servicing a building - the manufactured product in this scenario becomes the instrument through which the mechanical company develops a long commitment to, and relationship with the building and its owners/facilities management. One the most basic and influential components of PSS is that it draws into question the deeply entrenched relationship between economic growth and growth in material production.^[24] Under this new system, the material product is designed in such a way that the manufacturer assumes a degree of responsibility in its disassembly and servicing. As we have seen from the automotive industry and through a number of individual tech companies which have employed this

practice, there is an inherent desire to design for disassembly when responsibility extends to product reclamation.^{[1][24]} It is key that we look to PSS's in the technology sector, with a rapid rate of change, to understand the complexities of servicing integrated hardware components.

A social and economic benefit is the creation of jobs in deconstruction and disassembly. Demolition currently uses heavy machinery in a highly efficient albeit enormously detrimental way. A building may take 100 people to construct, and 3-5 to demolish. That same building may employ a deconstruction crew of 10-20 people, with many others in the chain of disassembly, processing and reallocation facilities. Deconstruction is an inherently labor-intensive, unskilled job that would require little special training or heavy equipment, and would likely help these unskilled individuals secure jobs in the construction industry.^[4]

A mature disassembly industry has the potential to drastically reduce the cost of new construction when using reclaimed materials. Current Green Building standards and rating systems such as LEED and Green Globes offer credits for waste diversion and materials' salvage.^[4] The Living Building Challenge (LBC) requires that all materials are tracked to identify potentially hazardous components, but waives this for salvaged materials. Both aspects of the LBC are directly applicable to the DfD material network. First, waiving this requirement expedites the reallocation process. Second, while the vetting process is extremely time-consuming and expensive for the early adopters, tracking components with a comprehensive LCA will allow us to determine the quality and material composition and use-history of each building component, making a whole building LCA attainable. Managing the knowledge database affords considerable job opportunity as well.

As these economic opportunities become obvious and competitive, the manufacturing industry will have both the opportunity and the pressure to redesign its products for disassembly, and position itself to exploit the new market.

REIMAGINING THE SYSTEM - END OF LIFE AT DIFFERENT SCALES

As a network for the disassembly and allocation of parts develops, the opportunities for adaptation at different scales becomes possible. The case studies in this thesis operate within a system that does not support them. As a result, their capabilities are limited to a kit-of-parts approach in most cases, where the building acts as a one-off system for disassembly and reassembly - it is a “closed-loop” system because it is not designed to adapt its components to other applications, or “product systems.” With a saturated disassembly industry, opportunities are created for disassembly at multiple scales. This thesis determines that each structure operating under the guidelines of the DfD industry should design for disassembly at each major scale of the building. We define these scales in the following categories:

BUILDING SCALES:

- 1) Whole Building
- 2) Large Assemblies, Section/Bay
- 3) Sub Assemblies, Partition Walls, Service Walls
- 4) Individual Component - As product/As material, molecular

Observing the principles of recycling and reuse, the whole building reuse option is our primary choice, if the building can accommodate upgrades. If the building will be disassembled, processed and transported, the highest levels - Whole Building and Large Assemblies - are the most difficult to transport, requiring a high energy input for reprocessing and transport. Scalable disassemblies is an important aspect to accommodating Department of Transportation (DOT) requirements, and especially as those requirements change over time. At the lowest level of reuse, recycling the Individual Component as a material, the energy required is also prohibitively high - if it can be avoided, it must. Design for Disassembly works best at a middle level of reuse, Sub Assemblies, requiring some disassembly for transport but not so much that the materials require a physical/chemical transformation. The feasibility for a material reuse industry rests on its ability to quickly and efficiently process and redistribute materials with a minimal reprocessing energy input.

CONSTRUCTION BUILT GLOBALLY

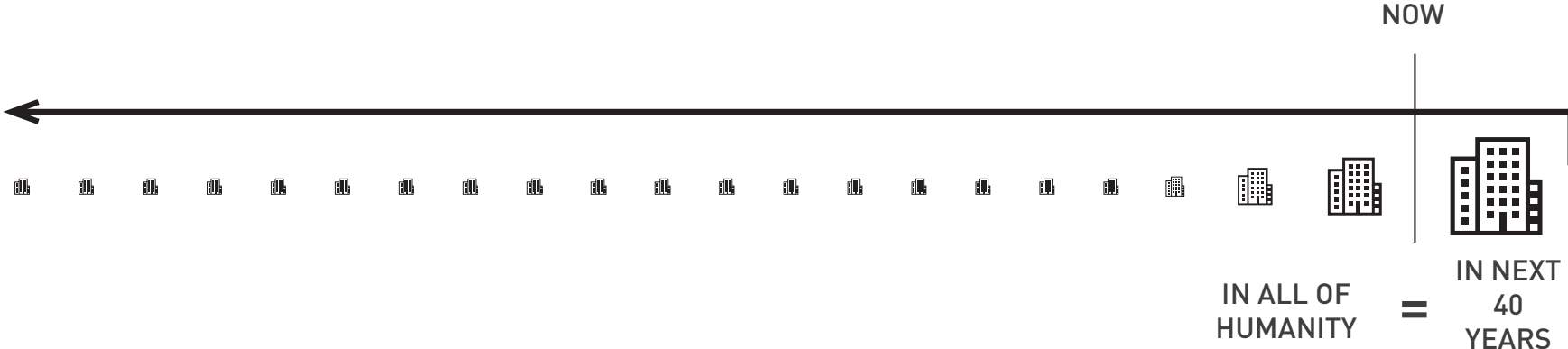

Figure 22. According to the U.S. Department of Defense, in the next 40 years we are expected to build roughly the same amount of construction as we have built in all of humanity.^[37]

THE CADENCE OF CONSTRUCTION

When considering the configurations of sub-assemblies and accessibility, the life span of each layer, service, and component must be used to inform early design. Accessibility means easy replacement. Inaccessibility means either locking obsolete components into walls, costly and complicated renovations, or in some cases demolition. The most resilient layer of the building is its structure, already the most deeply embedded in the building. DfD works if everything but that deepest, or “slowest” layer is removable. The sub-assemblies of the Skin, Services, and Space Plan layers all require independence from each other in order to allow one to be altered without affecting the others.

THE FALLACY OF “PROJECT COMPLETION”

In his book *How Buildings Learn*, Stewart Brand employs a diagram showing the “layers” of a house. Brand refers to the work of architect and spatial theorist Frank Duffy. Their firm, DEGW for whom Duffy was the “D,” has leaned toward spatial organization and interior design work because, according to Brand’s assertion, that’s where the money is.^[15] “Our basic argument is that there isn’t such a thing as a building,” says Duffy. “A building properly conceived is several layers of longevity of built components.” The four layers he proposed are “Shell” (structure - building’s lifetime or 35 years in North America), “Services” (HVAC, cabling, Elevators - replaced every 15 or so years), “Scenery” (Layout of partitions, dropped ceilings, etc. - changes every 5-7 years), and “Set” (occupant’s furniture - often shifts in months or weeks).

“Physical reality within spatial agency favours multi-use spaces, structures that are adaptable, projects that privilege the passage of time and acknowledge the realities of users’ changing needs and the inevitable transformations of space. In dealing with the temporality of the site they consider aspects that are rarely accounted for in a profession that sees its responsibilities limited to the here and now.”

- From DEGW Website^[16]

Brand’s own adaptation distinguishes between structure and skin within the “Shell,” and includes the concept of “Site.”^[15] His categories are “Site” (the physical context which outlasts many generations of ephemeral buildings - Site is eternal), “Structure” (foundation and load-bearing elements - 30 to 300 year lifespan, but 60 is typical maximum for many other reasons), “Skin” (Exterior surfaces - change around every 20 years for fashion, technology, or repair), “Services” (“working guts of the building,” working parts like lifts and escalators, communications, and HVAC - wear out or obsolescence every 7 to 15 years), “Space Plan” (interior layout including walls, floors, ceilings, doors - may be between 3 years for commercial and 30 years for slow-changing residential homes), and “Stuff” (Furniture, appliances and material possessions - “all the things that twitch around daily to monthly.”)

These categories are an appropriate way to understand the building as a series of layers. Similar to the design of a house, you begin with an examination of the Site, then design the foundation, structure, skin, services, space plan, and finally the tenants bring the stuff. Construction

follows the exact same sequence, starting with site preparation. The addition of “Site” in Brand’s model adds the influence of context to the equation. It is an important factor and although its material elements flow and change, depending on where you draw the fuzzy and unfixed border of “site,” it is likely to outlive the buildings within it. The “slowest” elements are the ones that will constrain and control the shorter termed ones, and at a larger scale and level of interaction. These ideas come from Robert V. O’Neill’s *A Hierarchical Concept of Ecosystems*.^[17] For example, the influence and interaction with the building at the community level will affect the site conditions, and may inform structural heights, skin conditions, etc., which tend to be the slower moving parts. The landlord (and utility companies) interacts with the services and maintenance of slower levels. Tenant’s and family organization is at the space plan level. The authority hierarchy operates in parallel with the building layer hierarchy. While none of these categories are fixed, and although the time evaluations for each “S” are approximations based on location, materials, and state of the industry, O’Neill’s hierarchy and Brand’s layers both offer a different understanding of the building. Each layer varies in the degree to which it is time-bound or timeless, and each operates with a particular set of stakeholders and constraints.

While the addition of “Site” is critical to consider the physical contextual influences, there are a set of quasi-tangible influences that are overarching and cannot be ignored. They begin to form a system within which the building is sited, built, serves its functional life, and finally EoL decisions are made. The site is the “grounding” and where the buildings meets the earth. This thesis proposes a seventh category for the purpose of categorizing the building as part of a system. “System” will be used to describe the frame of reference for the building project, that extends beyond the lifespan of each component, and even beyond transformative changes to the site and context.

CUMULATIVE COSTS OF A BUILDING

Evaluating the cost of the building is typically done with the structure and ground work outweighing the initial investments into the other layers of the house. While it is important to acknowledge the current narrow view that a building’s life ends at the same time as the structure’s life ends, using the structural lifespan as a basic unit of time for understanding the whole building is sufficient. It is also important to note that

these four layers - “Structure, Skin, Services, and Space plan” - are the most “built” layers of the building. These will be the primary focus of the investigation and model for designing for disassembly. Stuff, Site, and System all function outside basic building units and are influences on them. This thesis also defines and develops the “System” that governs and informs a process over multiple building’s lifespans. As the diagram shows, the initial structural investment is dwarfed by upgrades, renovations, maintenance and repairs to these three other layers over the lifespan of the building, illuminating a common misconception, and opportunities for the prioritization of flexibility of building assemblies.

DESIGN FOR DISASSEMBLY

Design for Disassembly is an approach to extending the lifespan of both buildings and materials. They are not mutually exclusive or inherently bound together - each layer of a building (the Seven “S’s”) are addressed at their greatest common value. In other words, when a product is disassembled, sub assemblies will be disassembled to a point where the simplified assembly has been reduced to only good quality, reusable parts, and can then be built up with replacement parts to be reintroduced into a project. If the product is being disassembled for recycling, the greatest value is material - only like-materials and those that can be recycled by the same process will remain assembled, hence greatest “common” value. The construction industry has been designing for assembly for decades, but has only begun to employ design for disassembly in recent years, slowly adding to the inventory of projects to learn from.

SEATTLE WASTE TRANSITION PROPOSAL

2016

2020

2050

2100

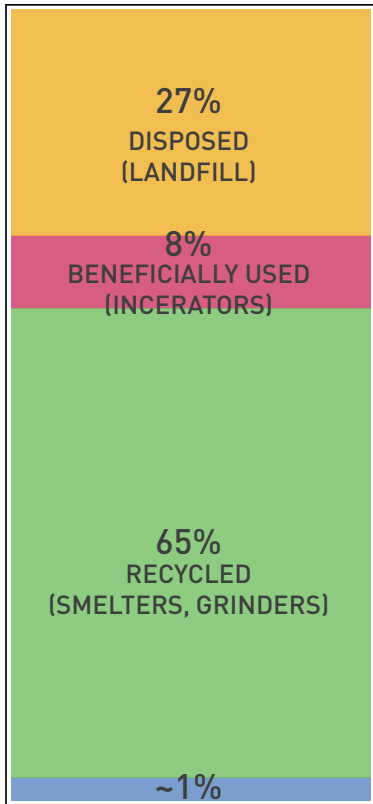

CURRENT
WASTE
STREAMS

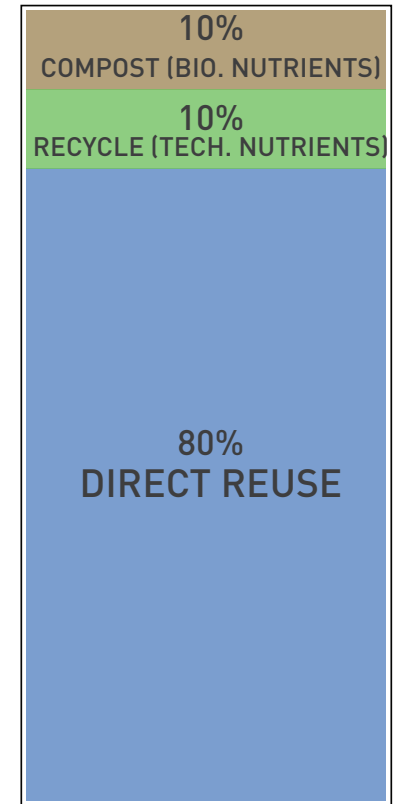
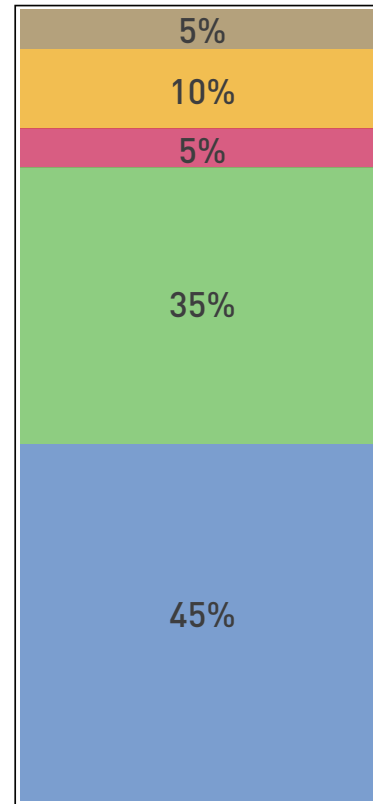
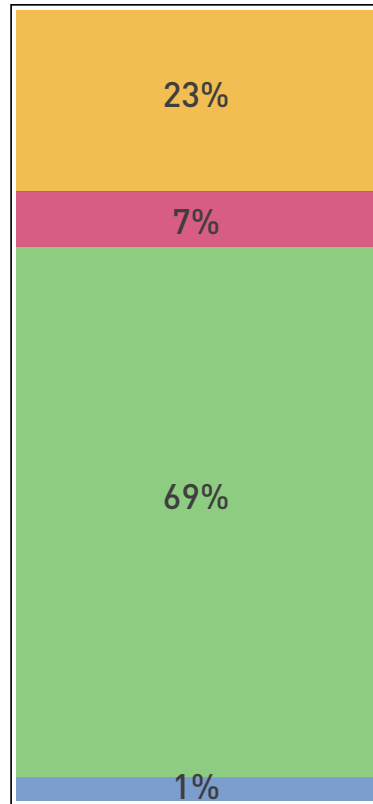

PROPOSED
WASTE
STREAMS



Figure 23. Waste Transition Proposal. Construction's rapid increase in rate and volume means that we are at a critical time - all sectors of the construction industry must strive to use buildings and their materials considering the future, flexibility, adaptation, and deconstruction. We must use our materials based on the constraints of scarcity and embodied energy. We must use them in perpetuity - because our resources are finite, we must use them as infinitely recyclable.





CASE STUDIES

A NOTE ON THE CASE STUDIES

Case studies are the most critical research component for evaluating the current state of DfD. Each of the case studies employs DfD in very different ways. The first two projects reviewed, the South Lake Union Discovery Center, and the Pioneer Square Pergola, are local Seattle projects that have dealt with DfD directly. They offer in the first case, a perspective from a group of professionals tasked with a design methodology none of them were familiar with - DfD; in the second case, the Historic Iron Pergola shattered but was already deemed permanent, so innovative DfD was employed to facilitate test-fitting, disassembly, and reassembly following its reconstruction. Both of these projects offer an intimate understanding of the opportunities and challenges in applying DfD in a construction industry not currently positioned to support it.

The third case study is a project by Danish firm 3XN which studies an internal project at every scale of design, production, and project delivery and operation. 3XN concludes that it would take only one or two decades to fully introduce a circular economy model in the construction industry (in Denmark.) Conclusions are also made about immediate and long term gains of implementing this new strategy.

CASE STUDIES:SLU DISCOVERY CENTER

DEVELOPER: VULCAN - HAMILTON HAZELHURST, JEFF SHARP

ARCHITECT: MILLER HULL - BILL FRANKLIN, DAVID MILLER

ENGINEER: MKA - JAY TAYLOR

CONTRACTOR: GLY - BILL DEJARLAIS

MOVING: ROBINS AND CO.

AWARDS: AIA AND COMMITTEE ON THE ENVIRONMENT (COTE) TOP TEN, 2017

CONTEXT

The South Lake Union Discovery Center (SLUDC) was first built as a marketing center for the mixed-use project across the street. Vulcan Inc. has developed 29 mixed-use projects in SLU, a district boasting 40,000 employees, 26 public art pieces to enjoy, and 1,000 dogs to pet on

Figure 24. Previous Page. South Lake Union Discovery Center.



Figure 25. (Above). Panelized OSB and rafter assemblies being hoisted into place. This process took less than one day.

Figure 26. (Above, Right). Glazing system brought “inside” vertical column. By moving it in so it only crosses the beams and does not intersect the column, the detailing requirement is reduced to only a short gap between the two sister beams.

any given day.^[26] The Discover SLU website features the now iconic Discovery Center as its main image. It is the building closest to removal, however, by disassembly and relocation down the road, within South Lake Union.

DEVELOPMENT MODEL

Hamilton Hazelhurst, a project manager at Vulcan, worked on this project when it was first built in 2004, the time when Vulcan began investing in SLU. The building, he says, might be the most flexible Vulcan has ever built (in terms of functionality), and now functions as their primary marketing center since it finished serving the adjacent project a decade ago.^[10] As SLU continues to densify, the prime real estate where the SLUDC is sitting is becoming more valuable. Vulcan had never planned to sell the building, in line with their philosophy until just a couple years ago. The company would “build to hold” property instead of building to sell. The Discovery Center was always to going to be moved, most likely as another Vulcan marketing center. The timeline wasn’t specified, but Hazelhurst and Vulcan had predicted it would be moved down to SLU waterfront park area five or ten years on. That park has now been developed, issuing the first of many likely problems to complicate its relocation.

EARLY INTEGRATION

Integrated design between architect, contractor, and engineer was crucial to the success of this project. Early lines of communication were necessary to determine the constraints for disassembly, which was outside the expertise of the designers of the project. Bill DeJarlais of GLY construction was brought in to the planning and design process early on. While he, like architects Bill Franklin and David Miller, had never worked on a building that would be disassembled, his involvement in the project began as both a cost-estimator and design consultant for moving the building.^{[13][11]} He worked with Robins and Company as a moving consultant to guide the sizing of preassembled and separated sections of the building. Westlake Avenue, a generous four-lane road, would accommodate a 45’ x 110’ module, according to Bill Franklin, Project Architect.^[11] Under this constraint, the building was designed in 20-foot bays, with two of those forming 40-foot sections for moving.^[13] The building could probably, according to Franklin, be divided into 20-foot sections for moving which could extend its range significantly.^[11]

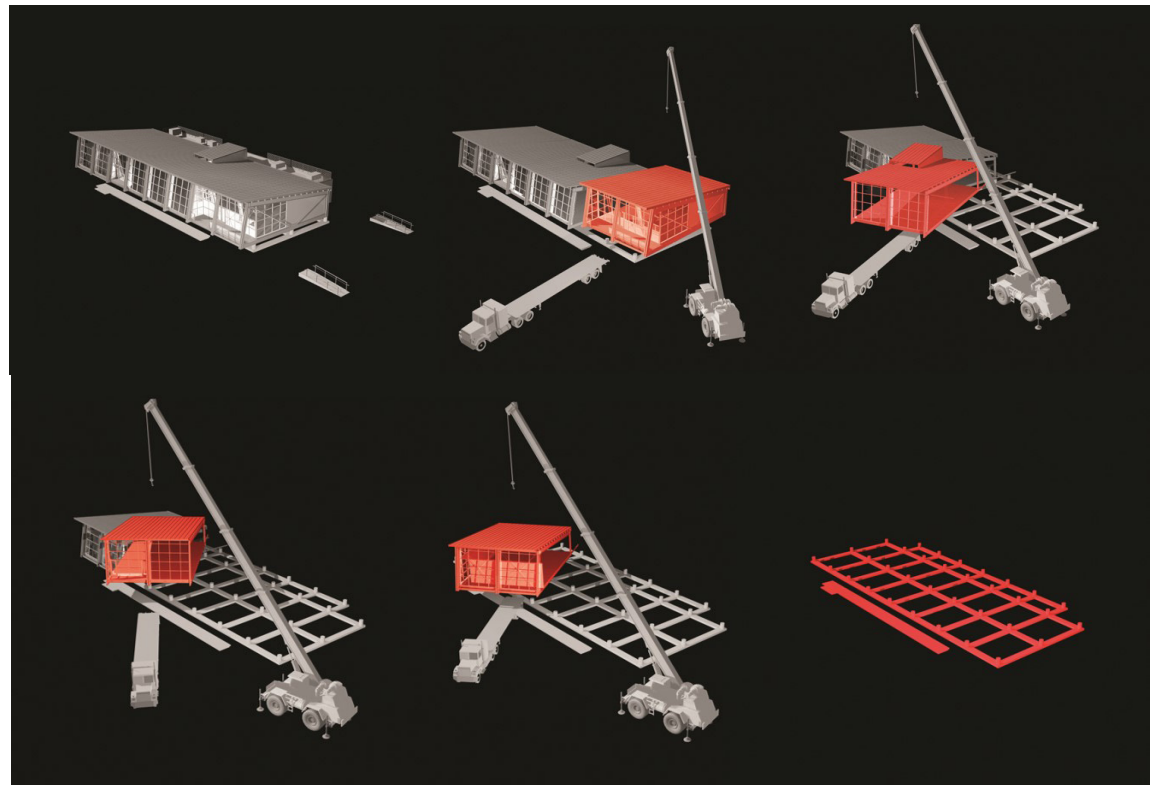

Figure 27. (Above). End bay of Discovery Center. Ramp hinge visible.

Figure 28. (Above, Right). Diagram of building sections being trucked to future site. Light foundation grid reduces permanent site impact and effort required for extraction.

Moving 40-foot sections, of course, would require full lane closures and a costly permit, performed at a specific time of night. With the redevelopment of Lake Union Park, Vulcan is looking towards a few undeveloped plots between Mercer and Valley Streets, or near Chandler's Cove, the marina area adjacent to the park. It is noteworthy that these sites are located within 5-10 blocks of the building's current location. The likelihood of finding a four-lane route of travel beyond this area would be a difficult if not impossible challenge.

DESIGN STRATEGY

With a strong desire from Vulcan to reduce on-site construction time, prefabrication was a driver of the assembly design.^[10] With concern about liquefaction, and in order to reduce concrete left on the site, the typical foundation was replaced with a grid of piers, similar to Sonotubes, connected by buried concrete "beams."^{[11][12]} The roof panels, once the steel support frame was in place, were placed in one day covering 11,000 sf, according to Franklin, shown during assembly in [figure ____](#). The panels are composed of four sheets of OSB and two glulam purlins. Their overall dimension is 8' x 20', determined by DOT laws. More than 12 trucks lined up on Westlake Avenue while a crane unloaded them one by one.^[11] The panels were set in place on the sloped roof, resting in brackets preattached to the steel frames. The bolting took one week, then once waterproofed, a temporary roof was in place. Once the pier's concrete had cured enough to support the weight of the structure, Franklin estimates that it took only two weeks before the structure had a sealed roof.^[11]

The steel frame sections are doubled - they are spaced 4 inches from an identical I-beam section. The 4-inch gap is the "gasket" or "seam" where the building comes apart. Due to access, the doubled beam created design challenges including insulation, and locating the window plane. [Figure ____](#) shows the unglazed frame wrapping the steel beams - had the glazing plane been placed in line with the steel columns, insulation or glazing would have had to fill the entire vertical gap between beams. Because the plane was recessed, only a small piece of glazing would be removed between the beams.^[11] According to the glazing company, the windows could remain installed during the move, but both Engineer Jay Taylor and DeJarlais said it was unlikely, and that the moving company would be reluctant to take on that risk.^{[11][12][13]} Once separated, each section must be free-standing. In an alternate scenario to the one in planning, the building could be split into sections and

each could be autonomous in its second life. Each section could be further disassembled, though most of its custom parts are idiosyncratic, and might require any new design to start with them in mind. The entire assembly uses bolts instead of welds, except the sections on either end of the building, with greater requirements for increased lateral loads.^[11]

Another feature of the disassemblable section are the MEP systems. Similar to the panelized system used in CollinsWoerman's 47+7 apartment building in Seattle's U-District, the MEP hookups are all located together on a disconnect panel. The mechanical engineer required four units for the space, and conveniently there are four sections. Each section has its own fully-contained disconnect from the main panel, so all the physical components for MEP were installed in the shop, and connections were made at one connection point by each of the sub-contractors once everything was in place.

A small, simple, but celebrated innovation is the entry ramp. It is attached to the building by a hinge, accommodating different terrain in its future location. It crosses over the rain garden, integrating two features that emphasize the project's overall position on sustainable design.

CONCLUSIONS

Vulcan is in a unique position to have a building of this nature, and with the ability to entertain the idea of moving it. A smaller owner might now have the pecuniary power to find a location within the 10 or so blocks within the four lane range. Beyond that, Interstate 5 can be accessed by Mercer Street, but that reduces the maximum width to 8 feet as per DOT regulations. Moving cargo below that width doesn't require a special permit. Hazelhurst anticipates another surge of development along the waterfront with mid-rise apartment buildings, which would mean they are ideally positioned to reinstate the SLUDC to its original purpose, just a few blocks away amidst emerging retail at the south end of the lake, a move that is estimated to cost between \$1-2 million.

CASE STUDIES: PIONEER SQUARE PERGOLA

OWNER: CITY OF SEATTLE

ARCHITECT: JULIAN EVERETT

RESTORING ARCHITECTS: JONES AND JONES (1973, 1993), RON WRIGHT (2002)

FABRICATOR: SEIDELHUBER IRON AND STEEL WORKS

CONTRACTORS: ANTHONY CONSTRUCTION, CORONA STEEL ERECTION,

MOVING: NELSON TRUCKING

AWARDS:

In his essay “Promoted to Glory,” Walter Whitehill relates two Greek stories, one of a single wooden pillar allowed to remain in a temple of carved stone as a mark the temple’s antiquity, and the second of an old wooden ship, meticulously repaired and boards replaced, so “the ship became a standing example among the philosophers, for the logical question as to things that grow; one side holding that the ship remained the same, and the other contending that it was not the same.”^[27] Two forms of preservation with different approaches, both imply permanence and temporality, and are among the first examples of historic preservation. What implications does this antiquated understanding of “living preservation” have for disassembly?

CONTEXT AND HISTORY

Built at the corner of First Avenue and Yesler Way in downtown Seattle, the “Iron Pergola” was erected in 1909 as a street and cable car stop. Designed by Julian Everett in an ornate Beaux Arts style and constructed of cast-iron components with a wire-glass roof, the pergola also marked the entrance to an underground comfort station known as the “Queen Mary of the Johns”^[28], allegedly the most lavish underground facility of its type in the country, and the only one west of the Mississippi. The 1910 edition of *Pacific Builder and Engineer* raved,

“The man of travels will find nowhere in the Eastern hemisphere a sub-surface public comfort station equal in character to that which has recently been completed in the downtown district of Seattle.”

It had marble stalls, white-tiled walls, terrazzo floor and gleaming brass fixtures ^[29]. Both installations were to impress visitors to the 1909 Alaska-Yukon-Pacific Exhibition.

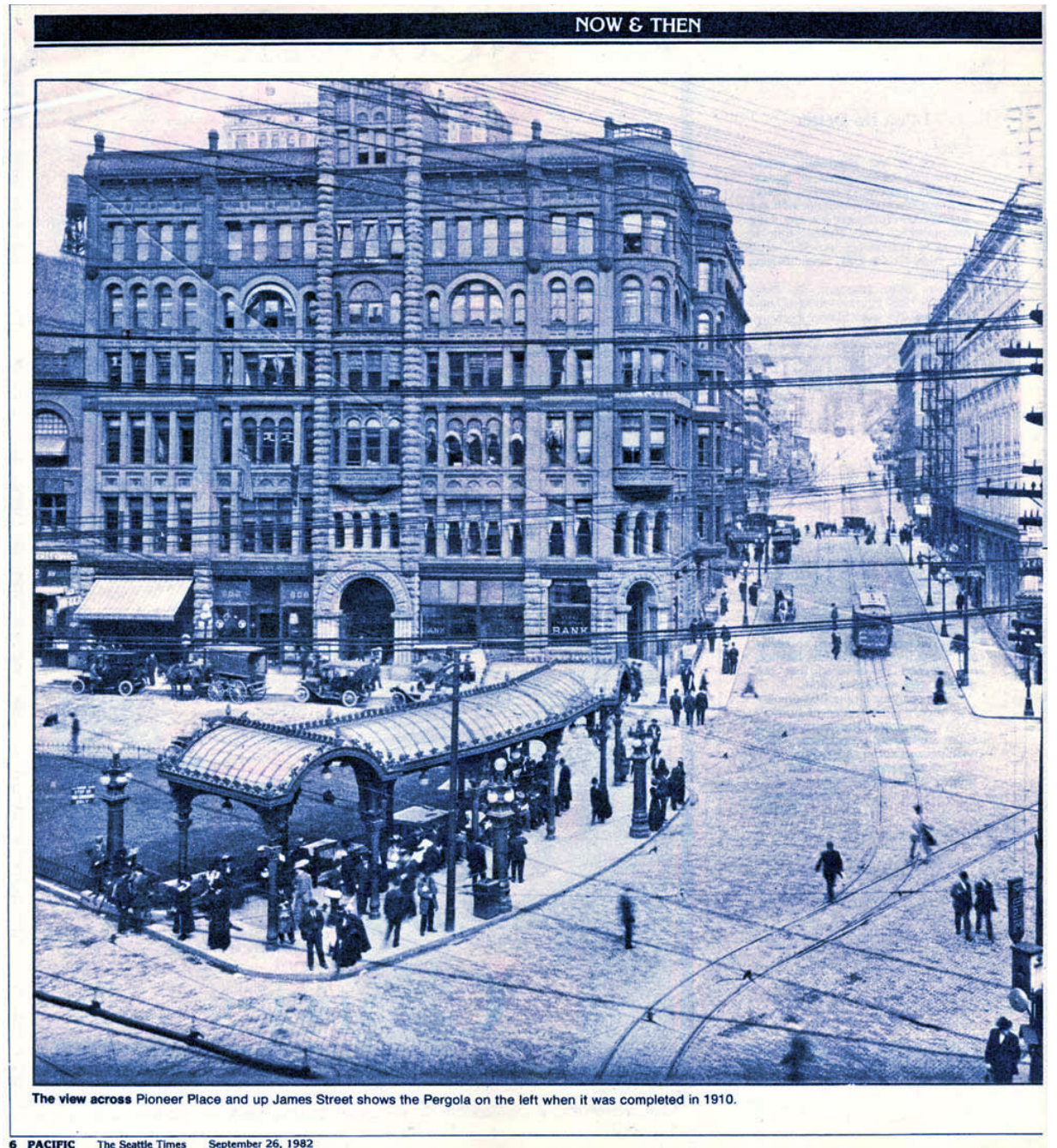

Figure 29. Pergola image from *The Seattle Times*, September 1982. Dated 1910.

NEGLECT AND RENEWAL

The post WWII era was one of neglect for the elegant restroom and pergola – during this time, the comfort station was permanently closed allegedly because its seclusion accommodated drug use, and due to the difficulty and cost of maintenance^{[29][30]}. Except for structural interventions supporting the new pergola structure in 2002, the 1940's marked the functional end-of-life of the comfort station, and no work has been done for it since. The pergola's cast iron and steel was rusting at connection points, and hadn't been painted frequently enough to carefully preserve some of the ornate iron pieces. The most significant alteration was that the original wire-glass roof structure, designed and installed by Westlake Sheet Metal Works, was in disrepair and replaced by a sheet metal roof during this period, completely altering the look and feel of the structure.

In the 1950's and 60's, the city considered re-development of Pioneer Square, meaning complete clearance and new construction. Because the downtown center had moved North after 1910, the buildings erected after the fire of 1889 remained mostly intact, however neglected^[31]. Woolbridge and Montgomery wrote:

“Today we need not regret that the commercial center moved on, leaving the area to stagnate. This lack of interest and investment insured that a remarkable stand of urbanistically compatible buildings from the end of the nineteenth century would remain. Streetscapes like that from the Pioneer Square south along First Avenue are rare in a modern metropolis forced to reuse the same downtown over and over.” ^[32]

The face of Pioneer Square continued to change - where the early 1900's represented a bustling new downtown, the Pioneer Square of the 1960s was threatened by a transformative loss of Seattle heritage through urban renewal. There emerged a surge of defense in the form of preservation work and the NHPA had an interest in both national and local historic preservation. In 1968 and 1969, Architect and University of Washington professor Victor Steinbrueck led a team of faculty and UW students to inventory the buildings in the Pioneer Square district to prepare for the nomination for the National Register of Historic Places and as a local landmark district ^{[31] [33]}.

STRUCTURE

The Pergola's ferro-vitrious structure was a structural symbol of its time. It combined cast iron and glass to create a decorative, light-filled structure doubling as a skylight for the comfort station. At 60 feet long, 14 feet wide and 16 feet high, the highly visible and well-used pergola and comfort station instantly became Seattle landmarks. The pergola would be tested through a number of incidents challenging its structural and historical integrity - Seattle's love for the Pergola proved stronger than the structure itself. Sited in what later became a dangerous location, the pergola's trials have ranged from minor to complete (collapse and restoration), and repairs have amounted over \$4 million. The repairs have been challenging to everyone working on them, due to the idiosyncratic nature of each component. How might some of these challenges inform material choices, siting, and construction assemblies? In particular, how could a different approach be undertaken to best facilitate future repairs?

RESTORATION WORK

On November 24, 1992, Jo Rekhi of Seattle Department of Parks and Recreation inspected the pergola following a piece of ornament falling off the structure and causing concern for pedestrians. The inspection "confirmed this structure is becoming a safety hazard due to excessive corrosion."^[30] The recommendations from the inspection^[34] including the sandblasting of all corroded components, supplying and installing all new polycarbonate lighting globes, caulking seams before painting, and manufacturing and replacing (4) capitals, (6) rosettes, and (4) swags. The project description also stated "to expedite the project, it is anticipated that these items will be cast aluminum, though cast iron may be used if required."^[30] Among the recommendations was "reattaching all loose pieces with fasteners or epoxy." Taken with these other recommendations, it appears that some of these processes would have been irreversible, and did not reflect the original materiality and craft of the pergola. Sandblasting, for example, erodes the metal ornament. Epoxy chemically bonds one material to another. Replacing the new pieces with aluminum suggests that at some point in the future the columns might be steel and the lighter structural and ornamental pieces would be aluminum, altogether eliminating the characteristics specific to cast iron. These substitute materials are not in keeping with the Secretary of the Interior's Standards. How is this an acceptable treatment? Does this historical detail matter? Is it worth recasting the structure



Figure 30. Pergola after devastating truck crash in 2001.

in different metals rather than allowing it to age as a cast iron structure would?

TRUCK CRASH, 2001

The most traumatic failure of the pergola took place at 6am on January 15, 2001. An 18-wheel semi-truck from U.S. Express Enterprises clipped the roof structure when taking the corner too sharply from Yesler Way onto First Avenue. While the city moved to appoint an architectural and engineering team, the pergola lay in a heap for nine days. On January 20, the Parks Department announced that they had contracted Seidelhuber Iron and Bronze Works, a company that had been involved in the original iron fabrication in 1909 and helped with the restoration in 1972 and 1973.

“It was like pick-up-sticks,” stated Seaman. “‘It just exploded.’ They had to rake pieces out of the bushes 60 feet away”^[35]. Because cast iron is brittle, and the hollow structure was originally used for venting the underground comfort station, the cast iron structure shattered, so did the glass roof. Buckets and crates were used to haul the broken pergola to the Seidelhuber facility in South Park, where the team “laid the materials out on the floor like an unfolded cardboard box” as closely as possible to how they found the pieces at the scene of the accident. Gradually, they moved these groupings of parts to plywood tables arranged throughout their shop and began piecing the parts together using duct tape.^[14]

There were only two sheets of plans from the 1909 project. “Plans that do not explain horizontal dimensions or even small incremental distances,” as she explained^[36]. To make matters even more challenging, Seidelhuber said the painstaking craftsmanship and construction methods from nearly 100 years ago would be difficult and impractical to duplicate^[36].

“What we’re finding is that the pergola was built like carpenters would build something – parts are not interchangeable and sizes are not standardized. So every column is at a different height and every distance between the columns is different. They beveled one side of a piece



Figures 31 and 32. Brittle cast iron historic material is fastened to a steel skeleton with mechanical joints and fasteners.

and the other end is square, like a bunch of broken knees going around a corner.” In some cases, Seidelhuber workers created cast iron pieces in the field, to make them fit^[30]. Most construction methods from 100 years ago have been superseded by new building technologies. The pergola challenged the manufacturers to question the practicality of recreating parts in exactly the same way. Was it feasible and economical? Would fabrication by a different method sacrifice the authenticity of the landmark? The solution was determined from a singular perspective, from which the most important thing to the community and city of Seattle was that the pergola was rebuilt to look exactly as it had before. On June 17, 2002, the first columns were placed back on the site. The assembly phase (which had already been carried out once in the Seidelhuber shop) took five weeks. An erection speed of five weeks meant thoughtful DfD. The pergola needed to be assembled in the shop, disassembled, and reassembled on site.

TECHNICAL RESTORATION

So what is the Pioneer Square Pergola now? Following the crash, with the need to reinforce it to meet seismic codes and withstand future collisions, this protected site received a transformative restoration. The structure is no longer just iron and wire-glass - it has 50,000 lbs of steel supporting a cast iron facade^[30]. According to Terry Seaman, 99 percent of the pergola was saved and rehabilitated. One percent - mostly decorative pieces - was recast^[30]. Cast iron, as it did in the original, makes up about 65,000lbs. This material, however, is no longer the supporting structure, but more like “wallpaper” as Seaman put it. Maybe this is a reductive description of a structure that once did so much. It’s historic character was structurally elegant - it was expressive in its structure, which was fully integrated materially with its ornament. It has lost this elegance, to those who know its story, that now there are layers of structure and ornament. The other major loss to its functionality, is that it no longer ventilates a subterranean comfort station. So no longer functioning as a bus stop, as a cast iron structure in its own right, or to ventilate the washrooms beneath it, the pergola stands now as a symbol of industry and change as much as a reflection of its initial purpose.

The 2001 restoration was exceptional because of the improvements it afforded the pergola above and beyond a typical restoration.

According to Seaman, if a similar accident took place after their work on the pergola, “the truck wouldn’t come out so well”^[30].



Figures 33 and 34. In Seidelhuber shop, Pergola is assembled to test fit, then disassembled before reassembly on site.

CONTINUITY, AND TIMING

A particularly important thread for this project was that Seidelhuber Iron and Steel Works had remained in business through all three of these “phases” of the pergola’s life. Heidi Seidelhuber was, according to Wright, the primary figure who designed the steel skeleton and did all the highly detailed technical drawings. She was now taking great care to reconstruct a project her Grandfather helped build 92 years earlier. According to Ron Wright, things also “got very political”^[14]. Mayor Schell put the pergola ordeal on his ticket, according to Wright, pledging that it would be reconstructed as a top priority. When asked if that was advantageous for the restoration, Wright replied, “Absolutely, it was really positive - there’s no way it could have been approved that quickly otherwise”^[14]. These circumstances were two of the main factors for success in this project.

A NEW WAY FORWARD

As some of the photos from inside the Seidelhuber shop show, the reinforced iron pergola is fitted with nuts, bolts, and other mechanical elements which make assembly and disassembly easier. Asked if this was a trend, Ron Wright responded that it was, and another iron pergola nearby had also recently undergone restoration. In downtown Seattle, Robbins and Co., who specialize in large-scale construction moving and are the company tasked with moving the SLUDC, have relocated a ferry terminal iron pergola to prepare for seawall construction. The pergola was upgraded to be partially disassemblable for ease of moving - it will be moved back to its historic location when the seawall is complete.

Designing for disassembly (DfD) has interesting implications - on the one hand, disassembly intuitively suggests temporality, the short term, or anticipating change. What disassembly means for preservation projects, however, is of a different nature. While we continue to design for permanence in most contexts, it is the truly “permanent” structures, and those fortunate enough to have National Landmark designations, which may be more likely to consider adaptability. The buildings that are landmarked are the ones we have already committed to conserving. They must withstand environmental (contextual) changes of different scales.

CONCLUSIONS

The iron pergola is inherently “fixed,” the nature of both cast iron, and rusting componentry. The steel skeleton that was fitted to the iron is flexible. While steel parts are rigidly secured to the iron, the new skeleton interacts *with itself* in a flexible way. Nuts and bolts, hinges, and access plates, all help the assembly points retain their functions and serviceability. Preservation work positions itself as a potential advocate for DfD, because they have historic material to preserve, and another structure to help do the preserving. That support piece is, in this case, the steel skeleton. We have already designated the historic material (the pergola’s cast iron), and it is up to the support structure to keep adjusting to context, and mitigating change and disasters. It would require a redefining of the “layers” of a building, because what used to be structure might now be only skin or ornament.

Case Study Takeaway Questions: To some, DfD inherently means eliminating old building stock and starting with all new componentry - how might this restoration inform adaptive evolution to existing fixed structures? How could a new construction industry emulate the ease with which this project was expedited (politically in this case), and the personal commitment and relationship of the Seidelhuber business to the structure? Would a PSS model work?





CASE STUDIES: DE FIRE STYRELSE

OWNER: CITY OF COPENHAGEN

ARCHITECT: 3XN

FABRICATORS: PEIKKO, MOSA FACADE SYSTEMS, VIA UNIVERSITY COLLEGE

CONTRACTORS: MT HOJGAARD

DEMOLITION SPECIALIST: KINGO KARLSON

CONTEXT

Denmark is currently recycling (downcycling in the same way as U.S. materials) 87% of their building materials.^[37] This is far greater than the 63% we see in the United States.¹ They are moving toward a circular industry at a more rapid pace, and there are economic models that begin to support that beyond governmental policy changes, which are often identified as the most practical way of implementing critical changes.

DEVELOPMENT MODEL

The economic and development models put forward in 3XN's case study book, *Building a Circular Future* have varying features. They share one key aspect - that the way we use our products changes from ownership to access. In other words, we begin to view and register building resources as "borrowed" from the system, whether that system be the Earth and natural resources, or leased products from one entity to another. The case study opens the conversation to how the economics would be structured. A building owner might not own the steel components in that building, but might lease them from the long term property owner. Alternatively, a steel manufacturer might be the ultimate owner of the steel - at the end of a building's life, those steel components would be reclaimed by the manufacturer. Having leased those materials during the occupation of the building, the building "owner" may have only paid a portion of what would have been paid if the materials had been bought outright. Or depending on the length of occupancy, could have been paid more, but the steel would be insured through the manufacturer, and paying the building off over time would mean a lower capital cost, interest, and liability is shared more evenly.

The steel manufacturer would carry more responsibility than when a component is sold. In this model, the manufacturer knows exactly how much steel it owns at any given time, and where it is. With sensors collecting on-site data, the manufacturer could be updated on the condition

Figures 35. Previous Page. Rendered visualization of De Fire Styrelser.

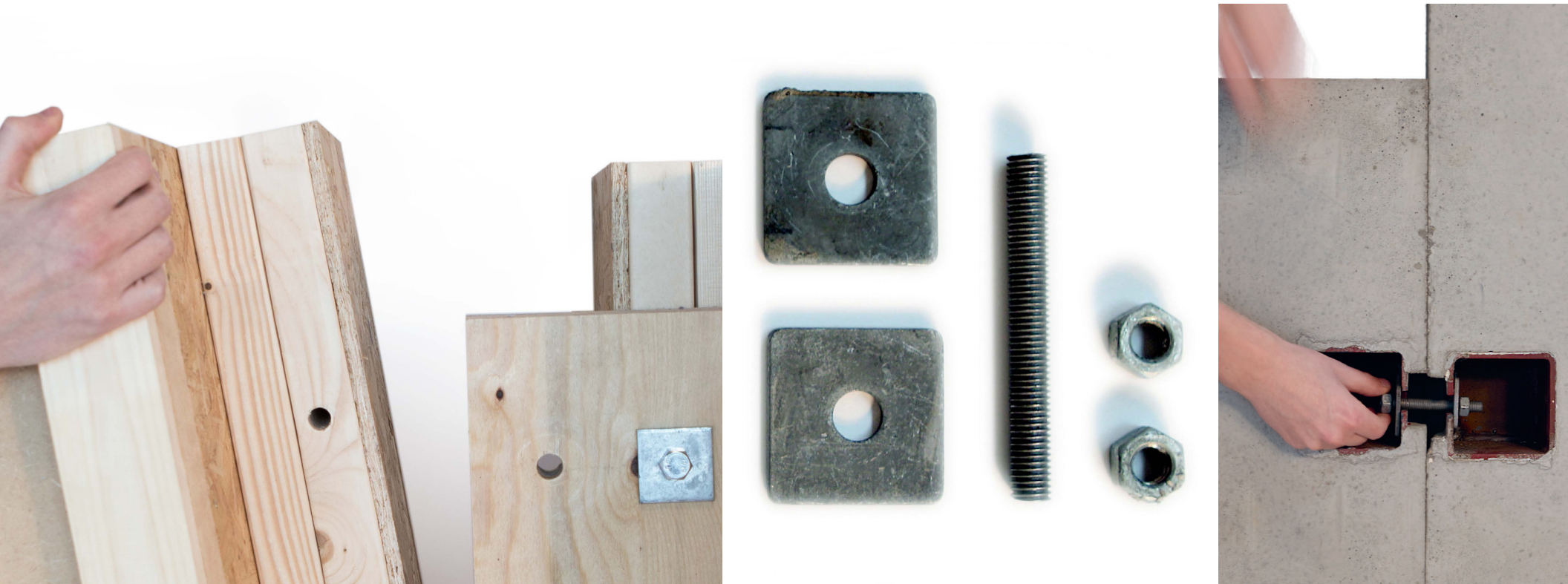

Figures 36, 37, and 38. Connection studies done by students at VIA University College.

of the material, and its exposures and stresses. New divisions of the construction industry, facilities management, or manufacturing could be developed to ensure the ongoing upkeep and quality of materials so that when a component is reclaimed, its grade and condition are unchanged. As materials grow increasingly scarce, this type of reclamation would be a huge cost-saving benefit. The manufacturer would not have to buy the more expensive raw materials, and could charge equivalent amounts for components that it only manufactures once. In a case where the component is damaged, they can reliably re-smelt and manufacture new components and know the exact quality of the inputs.

FEATURES OF THE CIRCULAR MODEL

Putting building components into ongoing circulation requires monitoring and documentation. A material passport is a way of recording a component's history. When testing is done on a material, the results are loaded into the passport ID. Ongoing updates allow any new buyer to look back at the component's first manufacture and each subsequent test or exposure. Designing for disassembly is a key feature of this model. Among the principle strategies are to make all connections visible, mechanical, dissolvable, and common. A building is not effectively designed for disassembly if its connections are not common, quickly demountable, and intuitive. Business models must also support the reclamation and redeployment of components.

BUSINESS

Of greatest importance to implementing this new model is to make a case for business and ensure its profitability. Reluctance around employing these principles, and sustainability and immediate risk-taking in general, center on the upfront investment. It is proven more expensive to design and build a high performance building, but it is paid off and more than compensates for the initial cost through savings in the total life of the building. Similarly, designing for disassembly represents an initial investment that many developers who "build-to-sell" will weigh with greater importance than added value to be reclaimed later in the building's life. The challenge of this proposal in the current climate, is that there is no industry to support a circular economy model. 3XN suggests introducing this model into the current system using straight-forward cost-benefit comparisons, and through positive competition. A study on a commercial building with a value of DKK 860 million concludes that

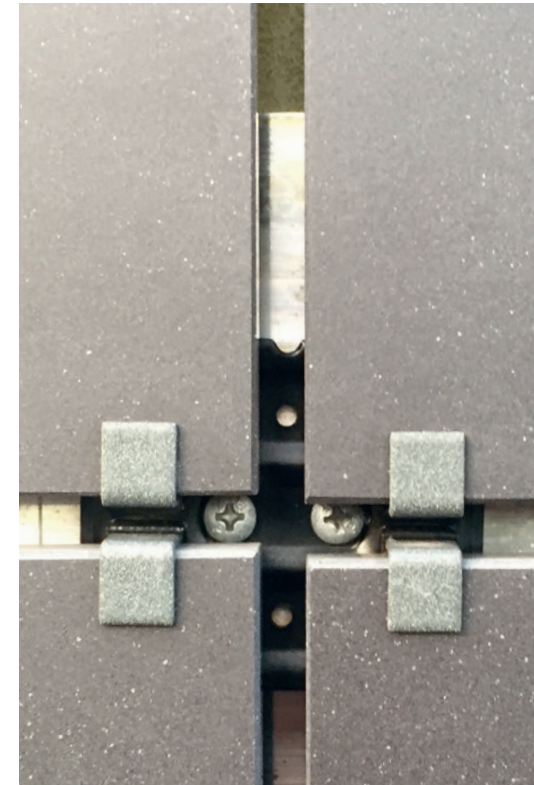

Figures 39, 40, and 41. Connections designed for both assembly and disassembly.

demolition costs would amount to DKK 16 million. The upside would be a DKK 35 million gain on resale (net gain of DKK 51 million). According to 3XN and resource scarcity projections, earnings will increase over time. This estimate suggests that in resale the building would earn 8% of its original value based on today's material prices, and 16% of its original value after 50 years, based on material cost projections.

The European Union (EU) allows clients of public projects to ask contractors to bid on full life cycle costs (LCC) or total cost of operation (TCO), meaning that they bid the cost of a “completed” building, plus the cost of operating it for 30-50 years. External competition puts a high performance building at a competitive advantage. Although it has seldom been done, this is an opportunity to add value through disassemblable and resalable materials. If a building's materials become assets at the building's end of life, it further offsets the cost of the initial construction.

CONCLUSION

Implementing a circular economy model into today's industry could be easier done with competitive standards, and policy changes allowing competition on new grounds. It is, however, possible to introduce this model in the current market climate. The resale of materials is a cost-benefit, especially if the largest valuable components are easily recoverable at a marked phase of the deconstruction. The understanding that resources are becoming harder to extract at the same quantity and quality suggests that buildings could act not just as material “depots,” but material “banks” where components actually accrue value over time. In whichever economic model, the owner of the material makes an investment every time a component is assembled in such a way that it is recoverable at the end of the building's life.

CHAPTER 3

METHODOLOGY

THESIS STATEMENT

The construction industry must adapt to the constraints of material scarcity, and reduce the environmental impact of endlessly mining, manufacturing, and discarding building components.

This thesis envisions a construction methodology that maximizes the utilization of our construction resources through design for disassembly and reuse, allowing components to last beyond a building's "functional life," and allowing buildings to last beyond their obsolete systems or style.

THESIS GOALS AND OBJECTIVES

ENVISIONING AN ALTERNATIVE TO DEMOLITION THROUGH DESIGN

As the research shows, material scarcity and resource quality demand a rethinking of the way we build. The thesis proposal aims to demonstrate, through the design and programming of a commercial building, how an industry with DfD values might take hold and develop. Through an investigation of material reuse in the current construction scenario, this thesis illuminates the sheer volume of material that could be reused which is otherwise incinerated, downcycled or sent to a landfill. Exploration of economic models will only suggest possible scenarios - development of those models and conclusions on their efficacy is beyond the scope of this thesis.

The urban and industrial strategy looks first at the existing building stock. It's first intention is to find value in what is there and adapt it to accommodate future program and facilitate change - direct reuse is the strategy with the greatest carbon displacement. The second level of reuse involves buildings and assemblies deemed invaluable as occupiable or feasibly rehabilitated. These will be disassembled and reused as either components or sub-assemblies where possible. This thesis is developed as a reaction to the present difficulty of extracting materials. Of great importance is developing strategies for dealing with the existing building stock as valuable material within invaluable structures.

The third level of reuse involves reprocessing materials. The research illuminates the actual cost of recycling. Recycling materials as shown in the timber LCA diagram - smelting metals, crushing concrete, and shredding wood for composites - requires energy inputs great enough to negate the benefit of carbon sequestration,^[22] and can be greater than the energy required for original production due to the additional steps of processing low quality materials bound or coated with toxic material. Recycling will be avoided when direct reuse, or reuse with only cosmetic reprocessing is possible.

Biological nutrients are biodegradable materials that are not embedded with, or bound together with toxic adhesives or coatings. Creating a healthy biodegradable waste stream requires monitoring of production and on-site treatment. Ensuring a biological material remains healthy requires new design thinking - that instead of coating wood with toxic preservatives, for example, the wood coated with biodegradable coatings, is protected from weather exposure, or is allowed to degrade with an anticipated replacement timeline.

Given the existing construction atmosphere, it is pertinent that we develop strategies for dealing with the existing building stock, especially in buildings that will be demolished but which contain substantial materials. This thesis focuses on this particular aspect of reuse - repurposing materials where the building itself is doomed.



Figure 42. Fisherman's Terminal and Interbay, looking South



Figure 43. Interbay Word Map - Main industry and landowners with Seattle Port highlighted.



Figure 44.

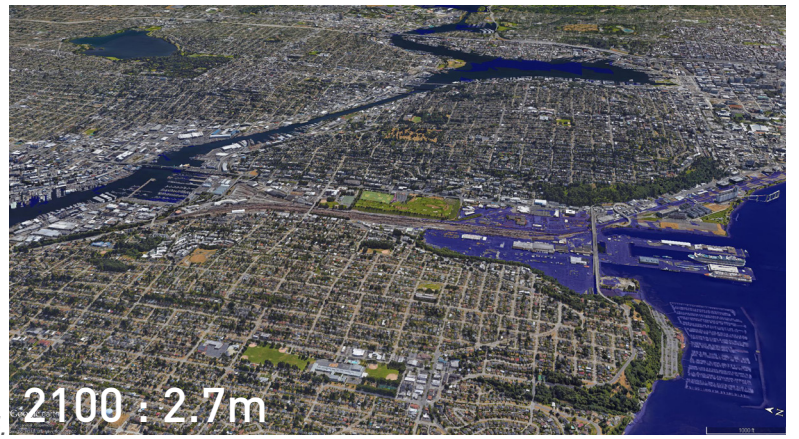

Figure 45.



Figure 46.

SITE SELECTION AND ANALYSIS

ANTICIPATING DEVELOPMENT ON A LARGE SCALE

This thesis argues that successful implementation of this new construction methodology can be faster in a saturated market, but that these principles and design strategies can also create a positive business case on a building by building basis. Availability is key to reallocating and efficiently cataloging and testing materials. Facilities will need to either be mobile or flexible themselves, or in a frequency that accommodates variable development rates and intensities. Choosing a site that has significant changes on its horizon is important, but in order to understand this problem and proposed solution, the project is best served if it follows an entire district with cultural and natural influences dictating the rates of change. The project will use the Interbay District as a prototype for a development strategy.

INFORMING INDUSTRY AT FISHERMAN'S TERMINAL

This thesis considers cultural needs and environmental threats. On the one hand, the district has great potential as development real estate. Interbay's location makes it extremely valuable as development real estate and as a connection point between different parts of Seattle and beyond. On the other hand, Interbay's future is questionable and is threatened by rising sea levels. The most recent SLR projections came out 9 months ago suggesting that maximum rise is more than twice what our previous estimates showed.^[38] This proposal is developed under the premise that at some point in the future there will be a policy mandating that any structures built in the sea level plane must be designed for disassembly. In 2100, with mean sea level rising as much as 2.7 meters, effectively putting S. Interbay underwater as it is currently built, we could experience storm surges reaching the Fremont Cut.

The site is Fisherman's Terminal which is owned by the port of Seattle and has plans under way to densify the property and increase manufacturing. The benefits of DfD is more appealing to long term property owners such as The Port, because they intend to keep their

buildings functioning for a long time and beyond the span of any single tenant's occupancy. On high value property with a high tenant turnover, the materials could actually be leased to the owner of the building. The owner of the materials themselves might be the land owner, like The Port of Seattle. When a tenant moves on, they would retain ownership of those materials. It would reduce the resale value, so the building owner would not make significant gains on that sale, but it would also have offset the initial construction costs.

Alternatively, the materials could be owned by the manufacturer. With resource scarcity and low quality raw materials being mined, construction component costs, and thus construction costs themselves, will continue to rise. The uncertainty of future material costs make guarantees of cost more attractive, so a steel manufacturer, as the owner of the materials, would reclaim them at the end of a building's life. They would have a guaranteed supply stream and would no longer have to purchase raw materials. Buildings would act as a material depots - at any given time, the steel manufacturer knows exactly how much material they own. The leasing of that material gives the manufacturer continued revenue, and offsets upfront cost for the buyer. Banks loaning money for the lease of these materials would intervene when a client could no longer pay the manufacturer. Insurance would play an integral role here where direct bank loans would not be sufficient for the transfer of ownership. Another model would involve the building's owners buying the materials upfront but having the opportunity of resale to manufacturers, contractors, or new construction developers. Contractual agreements setting a price for the future resale of the material may be a way for mutual benefit based on raw material cost projections in the future.

PROGRAM OF SPACES

DFD-BE RESOURCE MANAGEMENT HEADQUARTERS

The proposed commercial building design acts as the resource management headquarters for this new industry. Three main departments have different functions, each highlighting an aspect of this proposal. It is acknowledged that the industry-wide changes being proposed are

FOUR DIVISIONS

RESOURCE
MANAGEMENT



TESTING,
GRADING,
CERTIFICATION



KNOWLEDGE
DATABASE

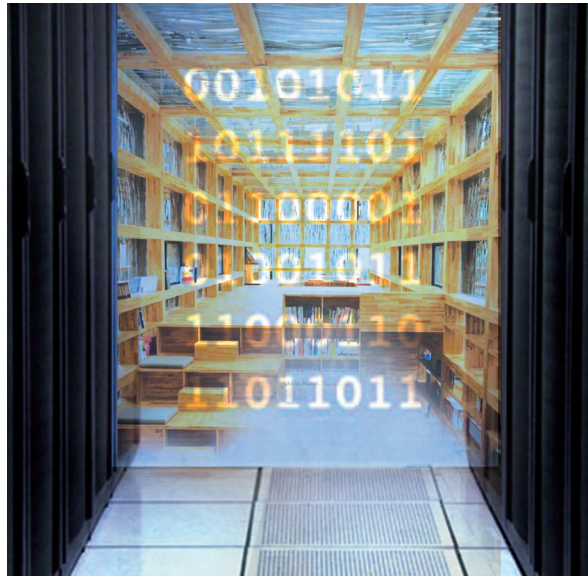

RESEARCH
AND
DEVELOPMENT



Figure 47. The four divisions of the DfD-BE Resource Management Headquarters.

monumental and could not be explored through a single design project. The departments are a way of illustrating new business opportunities that could quickly develop to augment the changes in the built environment. Each of the four departments is outlined below, as well as a brief description of the supporting programs:

1) RESOURCE MANAGEMENT

The resource management offices are spatially closest to the ground level public spaces. Clients frequent these offices when planning either the construction of a new project or the deconstruction of the old. Clients could be both developers, contractors and homeowners. This department is responsible for the procurement of building components. It coordinates the reclamation of materials from deconstruction sites, and determines the location and nature of their interim storage, testing, reprocessing and refurbishment. Resource management then redeploys these materials to be used in new construction.

Seattle's building reuse stores are the limited in size. Second Use Building Materials, Architectural Salvage, and Ballard Reuse are the only three stores in Seattle reclaiming and reselling building materials. Rhine Demolition reclaims some timber and mills it at its Seattle facility for resale. The face of architectural salvage must change if this industry is going to gain momentum - although an individual building designed for disassembly has inherent value in the resale of its components, there is no way to store that material. Storage is expensive, especially on urban construction sites, so great measures have been taken to procure materials in a way that reduces the amount of materials on site. The stores mentioned above are overcrowded and the pieces are idiosyncratic - seldom are there enough standard dimensional boards to frame a small structure, and their price is based on the inherent labor cost of extracting materials not meant to be extracted. Reclaimed materials then become novelty items to be used as decorative elements. One of the greatest challenges of this proposal is the storage of large quantities of commodity items.

PROCURING BUILDING COMPONENTS IN A CIRCULAR ECONOMY

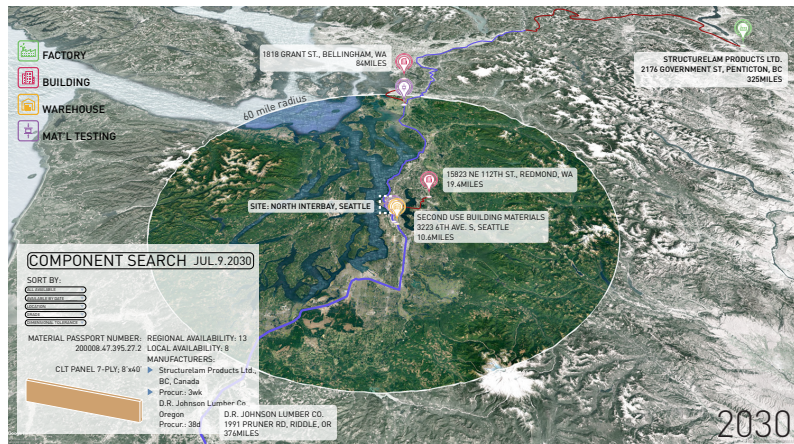

Sourcing CLT Component, 2030.

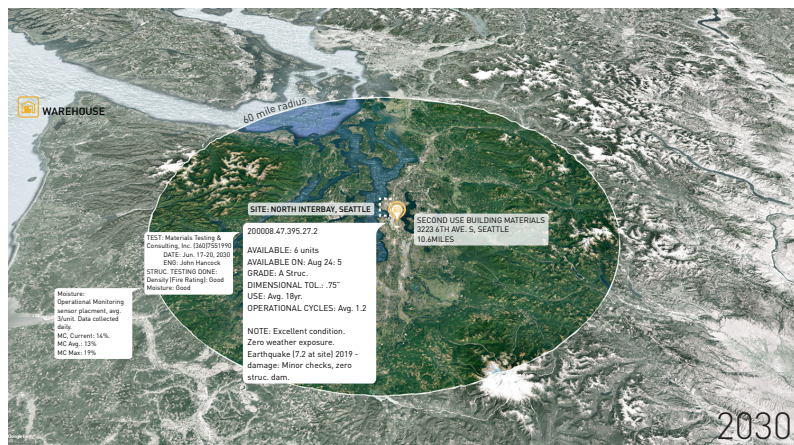

CLT Component Data



Sourcing CLT Component, 2060.

Figures 48, 49, and 50. How it Works: A circular economy changes our use of products from “ownership” to “access.” When sourcing building materials, nearby products are located (Left, Top). Individual products are tracked with “Material IDs” which record their specifications, exposure history, and anticipated availability (Left, Middle). Buildings act as material “depots” and deconstruction projects replace the new manufacture of products when sourcing building components (Left, Bottom).

Businesses would quickly see the advantage of selling only individual materials in this new industry. A store that can only store one of each item will not be competitive in a market moving a significant volume of basic components. Storage warehouses specializing in building components, construction consignment stores, and integrating material resale at transfer stations are all potential businesses opportunities in a DfD industry.

Materials must be kept in good condition while in use so they can be successfully reused in their second life. Resource Management would also work with the owners of the materials (either the building owner, or the long-term property owner, or manufacturer) to determine the best continued treatment and preservation methods. These could include surface coatings and limiting weather exposure.

2) TESTING, GRADING, CERTIFICATION

In this circular economy, where materials are sourced as second hand items, identifying and recording the history of a component could be valuable in their continued use. Material Passports, or the components identification, could be embedded into the material as a Radio Frequency Identification (RFID) chip, or other physical tag. The limitation with RFID chips are their relatively short battery lifespans of less than a decade, but strides will continue to be made in identification technology.

All materials should be tested to determine their quality and condition throughout their lives. Sensors able to track moisture levels in wall cavities and even in building components are becoming more commonplace, and could update material passports in real time. Components not testing in the field might be reclaimed from a deconstruction project and brought to a testing facility to undergo a series of evaluations based on the specifications or applications of the specific components.

Skepticism surrounds reclamation of building elements and their reapplication as a structural member. As a result, most reclaimed timber is used in non-structural applications as cladding or furniture. These are acceptable forms of reuse, though they discredit the inherent structural

properties in reclaimed timber, perpetuating the stigma surrounding reuse. The process is simpler than one might think, where a licensed grader can visit a facility and either grade materials visually or through simple tests. Rhine Demolition's lumber yard is dedicated to reclaiming building materials, and they are visited by graders who determine the limits of their future structural application.

Many building certifications programs focus on raising the standards and aspirations of architects, developers, and building owners, for the energy efficiency of their buildings, and their reduction of their carbon footprint. This department could be integral in certifying materials on their way to contributing to the overall certification of a building.

3) KNOWLEDGE DATABASE

The accumulation of knowledge is a benefit for any specialization or industry. Central databases for the sharing of knowledge do exist, but they are seldom shared freely across disciplines or company borders. This is a case where the entire industry and each business in it will benefit from a central database. Perhaps the idea of a knowledge database would fit better in a socialist society than in a capitalist one, but some degree of knowledge sharing would be beneficial. Supplementary to that, consulting businesses could form as subsidiaries to construction and deconstruction companies.

The knowledge database would serve as a library or archive that could be used by the public, and especially by contractors and manufacturers, to determine the most successful approaches to designing and constructing for disassembly. Individuals and companies could access disassembly manuals, Building Information Modeling (BIM) files, Visual Digital Construction (VDC) files, material passport information, and packets for specific connection types.

4) RESEARCH AND DEVELOPMENT

The design feedback loop, whereby information is transferred from a building's end of life deconstruction and the design and manufacture of new products and buildings, is an integral part of the DfD industry model. Transitioning from the current industry to one that embraces and even requires DfD involves different approaches. The first is that we must learn how to utilize the building stock currently available to us. Reducing the carbon footprint sees the greatest gain by direct reuse of a building already in existence. Architects and contractors do not openly share their discoveries or knowledge. Rhine demolition is an example of a company that does not share its knowledge - Deconstruction and salvage regulations are increasingly requiring contractors to extract more material than they know how to, and working with assemblies that aren't intuitively disassemblable. Rhine Demolition could act as a consultant on deconstruction projects that are built with traditional construction techniques, and buildings not specifically designed for disassembly.

METHODOLOGY CONCLUSIONS

Exploring opportunities for component reuse is only a fraction of the enormous task of shifting the construction industry towards DfD and introducing a circular economy. The scope of this thesis is limited to dealing with doomed buildings containing valuable materials, but the implications of the new building design, and of the design strategies employed to achieve future reclamation are far-reaching. The design proposal touches on a number of concepts: Panelization of assemblies, repetition, simplification of connections and a reduction of fasteners, prefabrication, and the use of standard parts and hardware are among them. While the thesis focuses on reusing materials that would challenge designers and contractors to use in standardized forms and modules, the design suggests that if it can be done with idiosyncratic components it can be done more easily with engineered materials, and especially with a design feedback loop from end of life material recovery back to design.

INITIAL CONCEPT SKETCHES

The following sketches imagine how the proposal could manifest at a district and building scale. Central to the thinking behind the Interbay Future Projection is the idea that our culture can be driven to pursue lost causes, and insurmountable obstacles. Since the industrial revolution, when steam ships meant we no longer had to rely on the whims of the wind, humans have taken nature's challenges as opportunities to exhibit our engineering might, as is the case in with the dredging of the Fremont Cut. With natural phenomena and disasters generally projected to increase in intensity, we are not bending to nature's will, but rather beginning to work with it. This image conveys the sense that we are welcoming the sea into Interbay, acknowledging and responding to its presence.

Figure 51. Interbay future projection. "Welcoming sea level rise." The district's resistance to change may mark its decline. By opening the floodgates and welcoming the inevitable, the district's resilience could be augmented by flexibility and the ability to reclaim and extract material from the threatened site.





Building materials and structural systems change gradually. While new products are always being explored, the common and irreplaceable materials are wood, steel, concrete, and glass. Seldom does one find a building without some combination of those four materials. Proposing a change to any common methodology is met with resistance, and it is far easier to introduce changes incrementally. Envisioning a commercial building designed to be flexible and demountable, this sketch considers a concrete foundation and column base with lighter, removable materials above it. A standard column grid with floor plates spanning between suggests that the floors could be removed or reconfigured. Central spaces and visual connectivity fosters an environment of interdisciplinary collaboration and the sharing of knowledge.

Figure 52. Light flexible structures over a more permanent armature could make Interbay more resilient as a district over the long term.

As the building develops, ideas about program adjacency begin to emerge. A Knowledge Database connects Resource Management and Research and Development, so it may inform clients and contractors (in Resource Management) how to best use building systems, and that it may be a platform of accumulated knowledge to begin to imagine technological advancements towards high quality, efficient new systems.

Figure 53. Programmed office spaces float within an armature structural system. The adjacencies of these four divisions are based on their need to overlap in function - the volumes intersect as a ven diagram where collaboration between divisions is common. A central court is visible to all building occupants and is host to collaborative demonstrations and events.

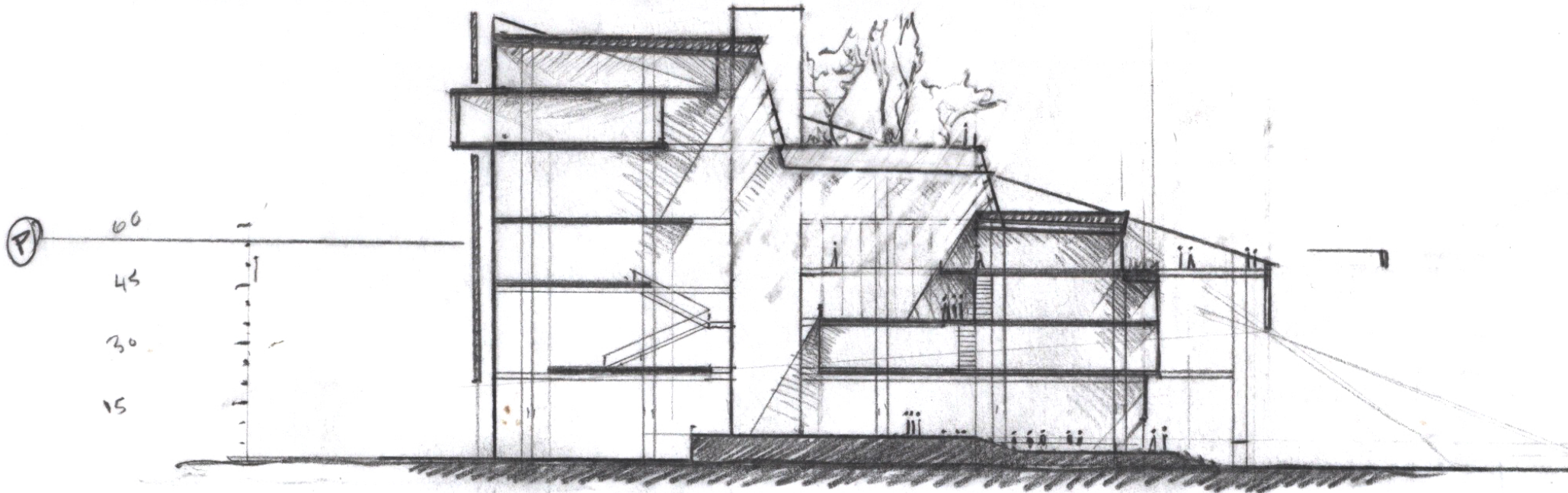

SECTION FACING EAST

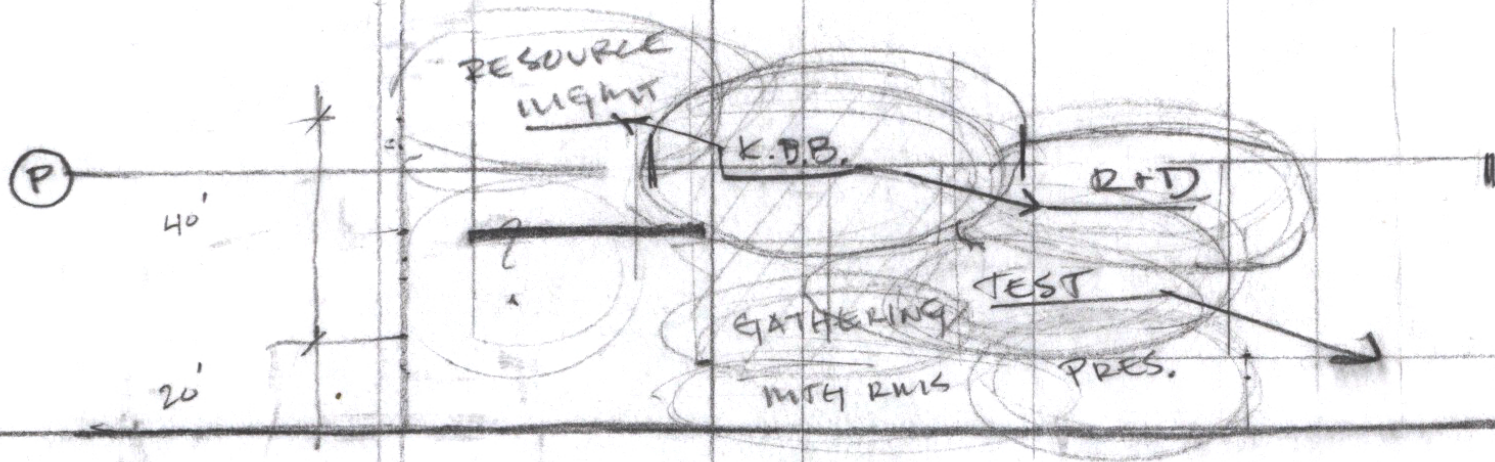

DIAGRAMMATIC SECTION

CHAPTER 4

DESIGN PROPOSAL

NET SHED ANALYSIS AND END OF LIFE DECONSTRUCTION: FROM THE TOP, DOWN

The highest level of reuse and greatest carbon displacement, as already stated, is whole building reuse. Some warehouses are adaptable and inherently flexible based on their open, free-spanning spatial qualities. Their value is in the near limitless program that their space can accommodate. Such is not the case with the net sheds at FT. Dense timber structures, built in phases, are idiosyncratic in their components and assembly. The construction methods differ from building to building, based on the individual carpenters and for being built at different times. All built in the early and middle 20th Century, their structures are solid timber. The clear fir used was found in great abundance at that time, and builders could afford to make warehouses that were structurally redundant and overbuilt. The volume of wood found in these buildings is astounding when compared to warehouses built a few decades later.

The feasibility of salvage is variable from one component to the next. This thesis approaches reclamation from the position that the greatest direct reuse represents the greatest carbon displacement. Thus, the design proposal intends to utilize the greatest amount of material possible to build the new building, without designing in excess of the building's needs. A common fear of dictated construction techniques, like policy that requires disassembly, or prefabrication, is that the design will be constrained and appear to be an obvious result of the rules the building was constructed by. There is partial truth to this, but this thesis contends that even complex parametric structures can be built in a DfD model

- Designing for disassembly should not limit the types and forms of buildings we produce, but should simply inform how we put them together. A parametric structure might be a kit of parts, but if it is designed for disassembly, it can be reused instead of being immediately reprocessed or sent to a landfill. It also means that it is recyclable down to the component level and all materials are separable from each other.

This design proposal examines every component in the net sheds and evaluates its ability to be reused based on its assembly and fasteners. Starting at the top of the structure, the end of life scenario for each material is determined:

EXAMINING THE OLD ROOF

2x6 fir tongue and groove (T&G) decking is nailed to purlins, composing the roof structure. This amounts to 8,695 cubic feet (cf), or 104,346 board feet (bf), to be incinerated. This is layered with a couple layers of 3-ply asbestos felt roofing. Two of the sheds have been there longer and have one more layer of tar felt than do the other two. This totals 6,550cf of landfill waste.

SHELL

26-gauge corrugated steel wraps the sheds. It is painted for protection - close examination shows heavy layering of paint, clearly done a number of times for upkeep. This means that the metal has lasted for decades, but also that its quality is jeopardized as a recyclable. The thickness of the paint - roughly equal to the thickness of the steel it covers - contributes to the slag waste in the smelting process. The steel amounts to 81cf of low quality recyclable material - its low density in its sheet form make it expensive to transport, and its high toxicity and volume of paint give it a low return on a toxic, expensive, and energy intensive reprocessing.

STRUCTURE

The structure is a dense post and beam assembly. Solid fir boards are reinforced with cross bracing and structurally redundant. The four structures contains 18,062cf of wood, or 216,744bf. Most of this would be incinerated because of the difficulty of separating the boards and of extracting all the steel (nails and plates).

FOUNDATION

The concrete piles, footings, stem walls, and slab constitute the substructure and 31,912cf of material. That would be crushed and used as fill, asphalt aggregate, or left in the ground.

TYPICAL
END OF
LIFE

NET SHED CONSTRUCTION

NET SHED INTERIOR

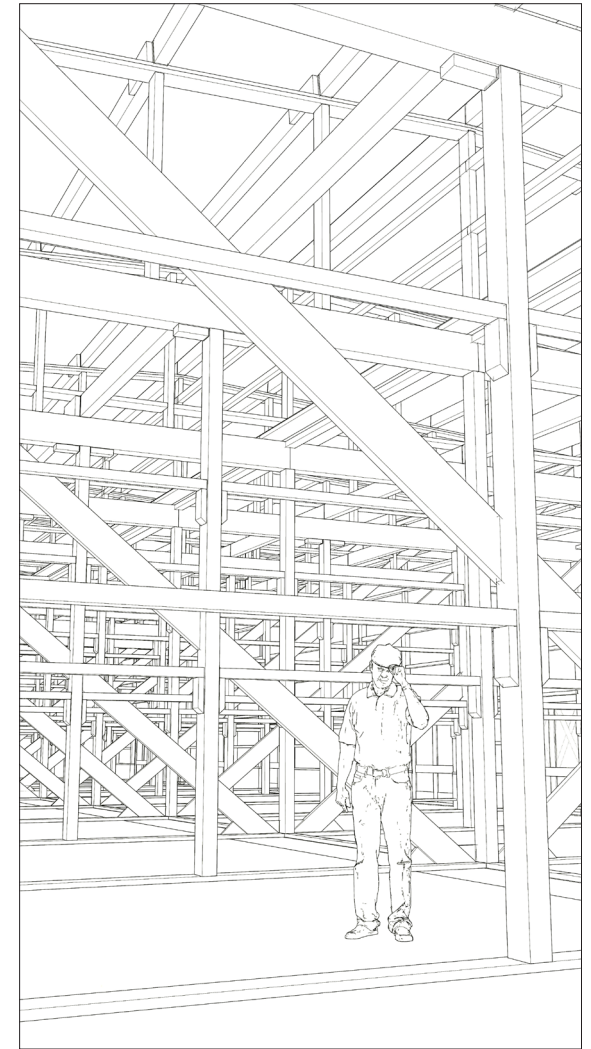
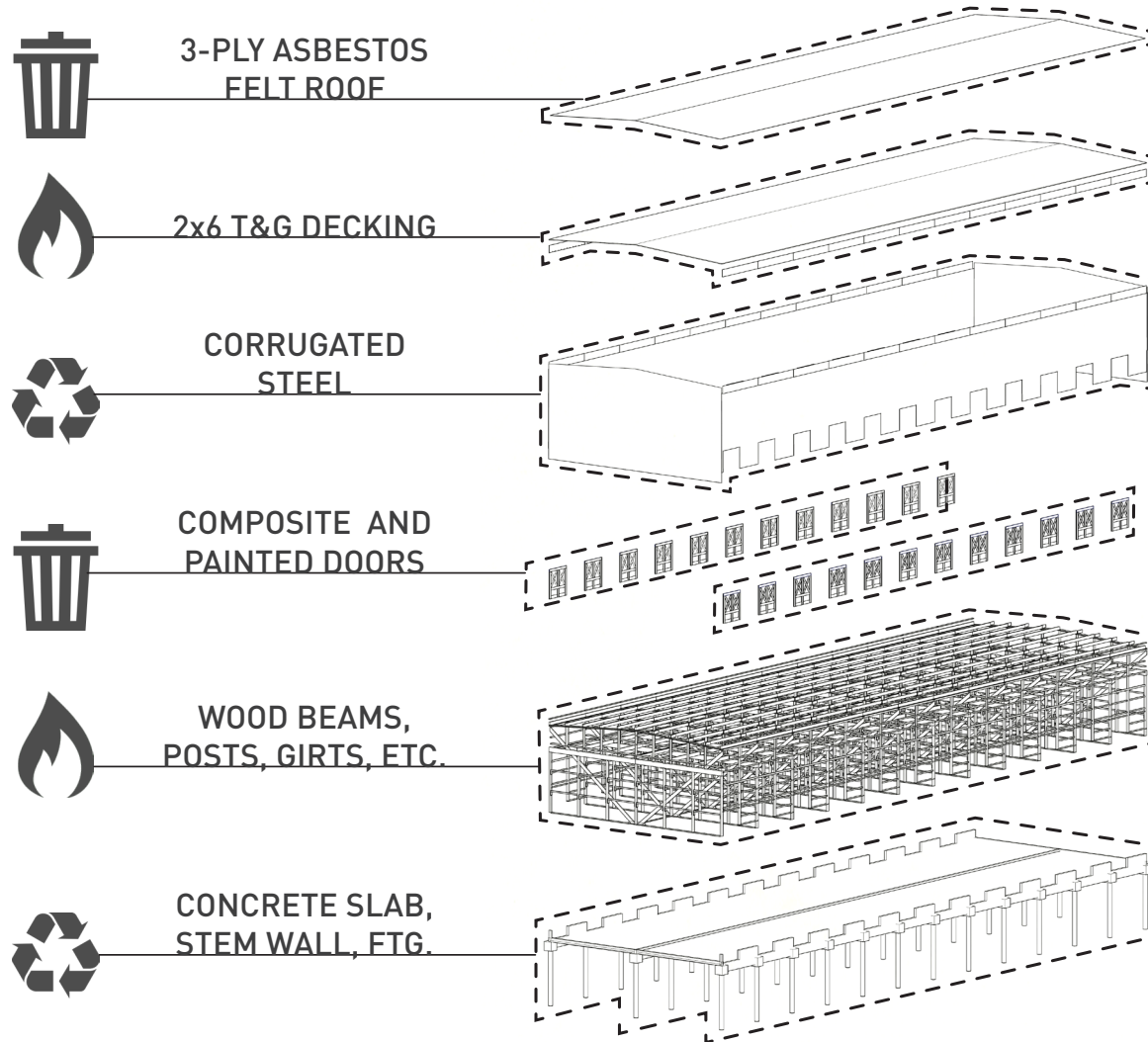

Figure 54. (Above, Left) Material breakdown of net shed structures. Figure 55. (Above, Right) Show the interior structure of one of the net sheds. Designed originally for its current use, the dense structure would make it difficult to reuse these buildings in their current form.



INDUSTRIAL DIVERSITY AT FISHERMAN'S TERMINAL



Figure 56. (Opposite) Fisherman's Terminal (FT) has been a center for Seattle's maritime industries for decades. The Port has plans in motion to densify FT and increase the presence of manufacturing. The West Wall is to accommodate new buildings which will replace the old, underutilized net sheds.

Figure 57. The four net sheds highlighted (Below) are full of solid fir dimensional lumber. At the time they were built, lumber was milled at larger dimensions than it is today. There is value in the sheer volume of material, and also in the antiquated cut of the wood. The wood itself develops properties over time, hardening from the weather and retaining the strength they had at the time of building. These changing properties are considered when reclaiming building materials for reuse, and lumber graders are given special training to accurately grade antique timbers.

ASSEMBLY STRATEGIES

BASIC DfD ASSEMBLY

There is no set rubric or set of rules for designing for disassembly. We must recognize the gradual rate at which construction technology has developed incrementally based in part on available resources, acquired knowledge, and cost. If we change completely our methods of construction, as parametric design and 3D printing threatens to do, we lose touch with the accumulated knowledge of centuries of building. Continuity is key for bridging the gap between the present and the future. We are not reinventing the wheel - much construction already conforms to the DfD principles. We are not, however, thinking in terms of a building's disassembly. We are instead always refining the design of assemblies for efficiency, and increasing erection speed. DfD must simply be understood as a further refinement of this process that does not stop at a fixed deliverable, but a flexible one that is impermanent on a greater time scale. A building is permanent if we look at it through the lens of a single day, but expand our perspective to a couple decades, and we will see how impermanent a building actually is. Economic models in the circular economy aim to support this revised perspective.

“Screws and bolts instead of nails” is a principle that is simple enough to understand. And yet in many cases that is not enough. What happens, for example, when screw heads are painted over or covered with caulking? Or when the screw head is stripped? Deconstruction of screwed assemblies is often more difficult than nailed assemblies because nailed boards can be pried apart or removed with a claw. Hardware and fasteners should be either exposed, or intuitively revealed for removal.

PROPOSED ASSEMBLY STRATEGIES

New construction provides a clean slate - with an additional fraction of the effort required to design a building, we can design disassemblable assemblies. We can use prefabrication for increasing on-site disassembly speed. And what do we do with materials reclaimed now? The existing building stock is an opportunity to prefabricate idiosyncratic components to demonstrate the simplicity, and design freedom of this endeavor.

BASIC DFD ASSEMBLY STRATEGIES



Nails damage the material

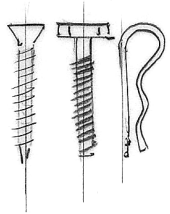

Use screws, pins, nuts and bolts

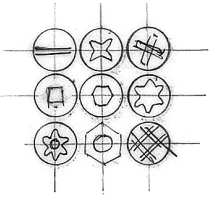

Fasteners can be found in all shapes and sizes

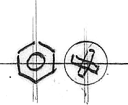

Use common and similar fasteners

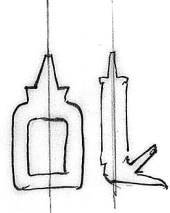

Avoid glue and sealants

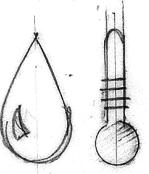

Use easily dissolvable binders

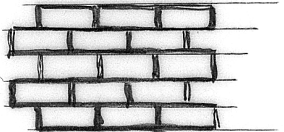

Portland Cement is impossible to disassemble

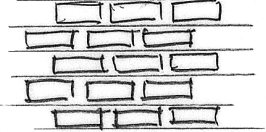

Use lime mortar instead

Figure 58. Basic strategies developed by 3XN

First, assemblies that are by all intents and purposes “fixed” together with excessive nailing, adhesives or coatings, can be cut into standard-sized modules. This limits the labor of disassembly, and maximizes the material reuse. This method also allows the module to be used again - instead of repeating the same mistake and reclaiming material only to be excessively adhered to its next assembly, fewer, stronger fasteners are exposed and secure the entire module instead of the individual pieces of it.

Small boards not already fastened together can be grouped for simple applications - stair treads and walkways, wall sections and furniture don't use any single dimension, but can be creatively modified when a number of like-units are available. This will be one of the great joys of designing with reclaimed materials. No longer will we be working with unique parts, but we will store and reuse large quantities of the same component. These parts can be called “standard” by the very nature of having many of them available at a given time.

Old materials can be reinforced with new components to extend their lives and capabilities. By adding a king post or tensioner to a sagging beam, or by assembling multiple weak components, a reclaimed material can be used more effectively than it was in its first life. Fastening antique materials with new connectors can make disassembly fast and efficient, and reduce damage to the material. Mechanical joints on previously cast parts adds a new level of flexibility to concrete, cast iron, and earthen building materials. New components must employ these strategies in the most elegant form achievable. From rivets, to bolts, to mandrel and cotter pin assemblies, steel I-beams could be hoisted away without picking up a single tool.

PROPOSED ASSEMBLY STRATEGIES

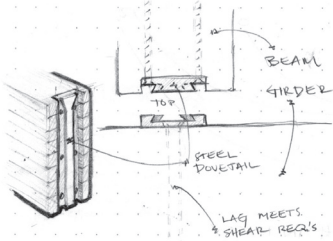

Adapt common materials with DFA/DFD fasteners

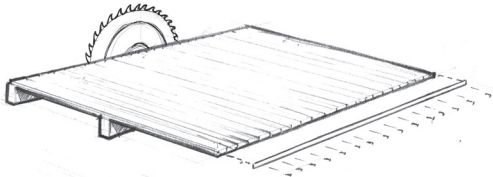

Cut existing assemblies into standard modules

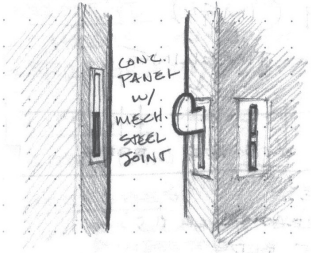

Concrete panels use mechanical fasteners

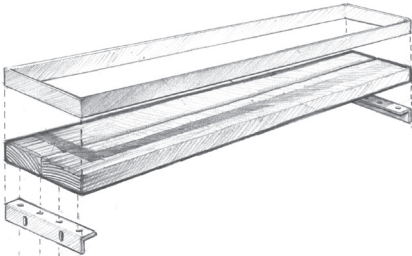

Small boards become panelized

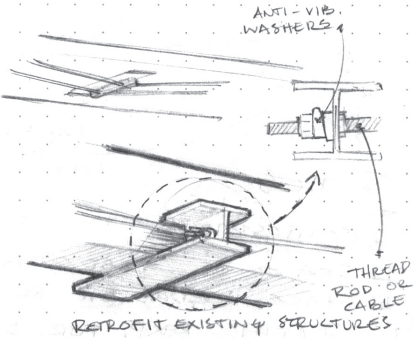

Old materials are reinforced to become structural

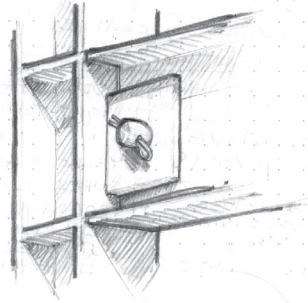

New components use only efficient DfD connections

Figure 59. Proposed Strategies

REUSE APPLICATIONS

EMPLOYING DFD STRATEGIES FOR NET SHED MATERIALS

The following assemblies are explorations of how a large portion of the net shed structures could be repurposed. The reclaimed members are reinforced, panelized, and anticipate multiple lives based on their ability to be disassembled as modules.

The tongue and groove (T&G) decking comprises 46,800sf of roofing. This is equal to just under 2.5 wall-to-wall floor plates of the building footprint. The mezzanines were designed with this number in mind so no extra floor structure would be needed. The three main stairs in the building constitute 540 steps, or 1,080 3x6 boards. The remaining 320 boards (160 units) are used for the bridge walks and smaller staircases. This means all 6-foot girts are utilized by the new building through panelization.

The largest components, 8x16 pole beams, are fully utilized for column assemblies. The 6x8 posts are used as the facades structural system with some left over to supplement other structural assemblies including short-span beams and girders. The 3x12 planks and braces are used as the glazing stiffeners with 20 remaining - these are used as the treads and elevated walkways for wider stairs and bridgewalks. The 2x8 louvers of different lengths are assembled to the stiffener-post structural system. 30,555 feet are required, of which 29,168 feet are supplied by girts, plates, and studs. The bottom plates, sitting on the stem wall and slab, were not considered reusable. Today, these would be pressure treated (PT) wood, and landfill material - because they are the connection point between concrete and wall, they experience more significant moisture and temperature variation than the other parts of the structure. That said, it is not unreasonable to expect that among these and other boards used for ladders, door headers, and shorter braces, good wood could be salvaged for the remaining 1,387 feet of louvers.

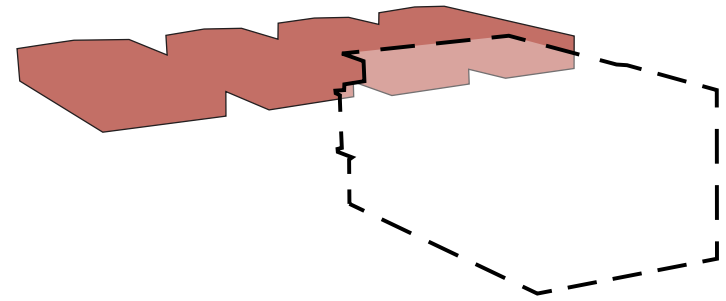

Figure 60.

ROOF + CLADDING

The majority of the building's skin is glazed, except for new volumes (CLT assemblies) which use a double skin rainscreen system with wood cladding. The glazing protects the large inventory of wood material in the new building, in such a way that it does not have to be treated. It is clean fir and will remain uncoated so that it may be used as either a non-toxic fuel or a biological nutrient at the building's EOL.

STRUCTURE

The structural system remains mostly timber elements. Because the new commercial building is now over 80ft tall, the reclaimed timber needs to use multiple members for single columns, and to be reinforced by steel components. The main structure follows a simple grid, with floor plates spanning between, echoing early conceptual sketches.

FOUNDATION

Foundation systems are always built as permanent additions to the site, to be extracted and crushed at most, but often left in place. This proposal envisions a foundation that unitizes the footing and column base, where the connection of these two elements might be a point of weakness in a modular system. Taking inspiration from small "diamond piers" used in residential deck construction, the proposed design enlarges the pier blocks and drives substantial (50ft x 12" diameter) piles through prefabricated sleeves to anchor the footings. This reduces the depth of concrete into the ground, and allows for removal of the piles and footings for reconfiguration or extraction.

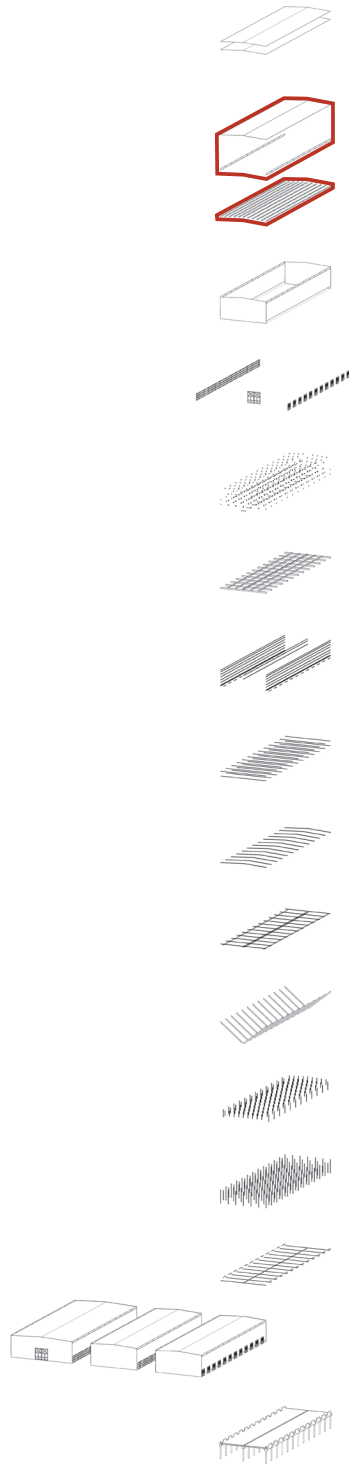

2X6 T&G WITH PURLINS

46,800 sf (T&G @ 1.5")

The shed roofs are fir 2x6 tongue and groove car decking. Nailing usually occurs every two feet, on each board, so they are heavily bound. Separation would cause splitting along the tongue and ruin nearly every board without laborious care. The time requirement makes recovery of these items cost-prohibitive.

The decking is nailed to the 6x10 purlins - large-dimensional fir - which would all be discarded because of the difficulty of separation. Incineration is the likely end of life scenario, a lost opportunity for such high-quality clean lumber.

Typical End of Life

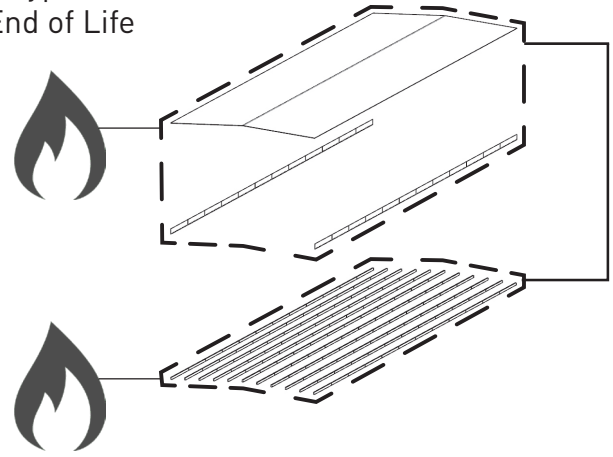

6"x10"x16'

(576) 5832 cf : 40,660 bf

REUSE APPLICATION

A proposed solution would be to cut the decking and purlins into standard modules to be pieced together. Edging would make the pieces fit tightly, and additional joists could be added to increase strength.

They are naturally strong enough for standard occupancy load, but would need some reinforcement if they were to be used in areas with large mechanical equipment or high capacity gatherings.

Because the mezzanines do not need to be conditioned like the programmed office spaces are, the tongue and groove decking can be left as-is. The decking would likely be covered by a floor system with sound-dampening material and a moisture barrier.

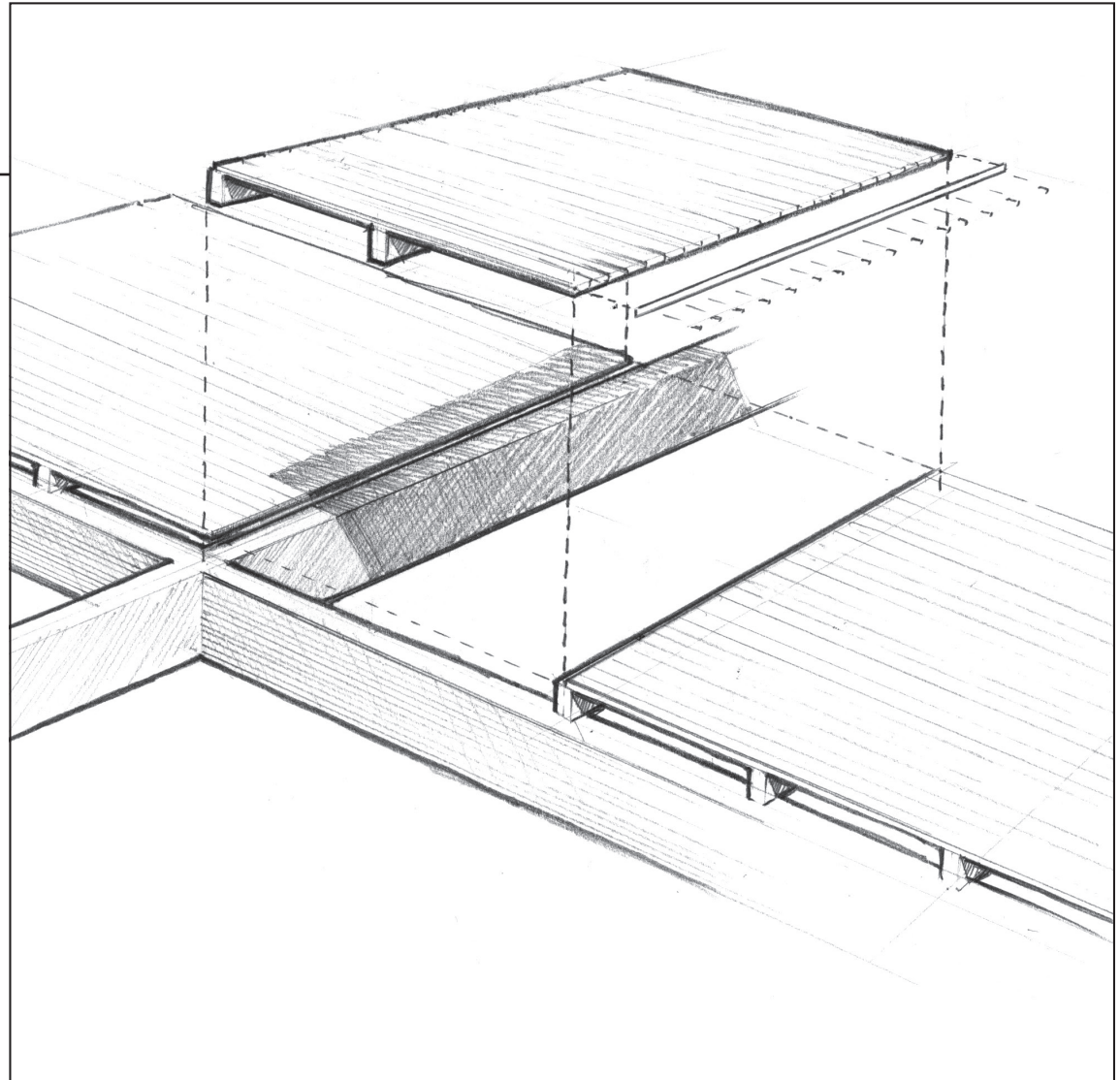

MEZZANINE FLOORS

Figures 61 and 62. Axon of T&G decking and purlins, and their repurposing as the mezzanine floor assembly.

POLE BEAMS 8"X16"X20'

(169) @ 8"x16"x20'
(260) @ 6"x12"x16'

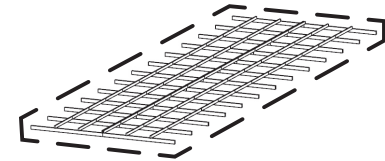

4559 cf: 54,905 bf

The pole beams are the largest timbers in the sheds. It is hard to imagine a scenario where the demolition contractor would not reclaim these members - in the case of Rhine demolition, they would likely denail and remill the beams at their lumber yard.

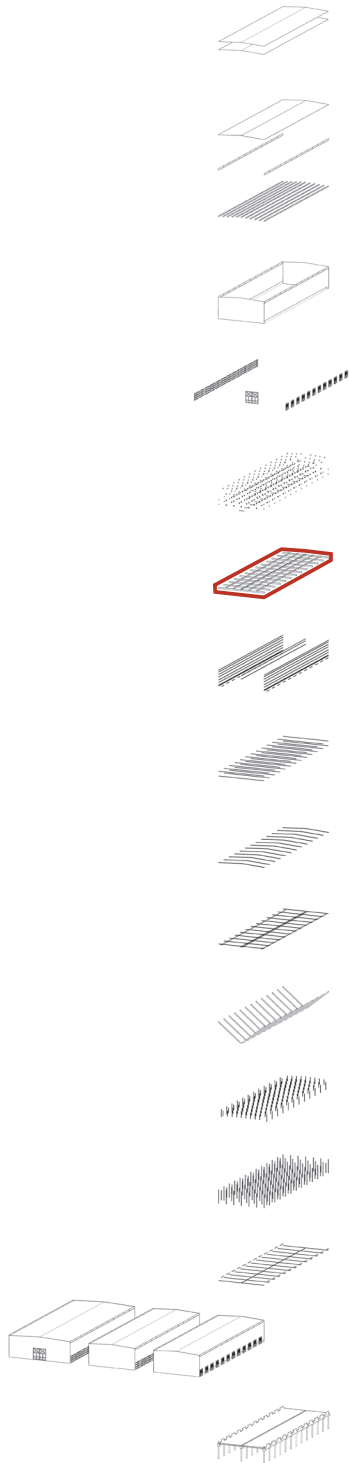

REUSE APPLICATION

grading, it would be determined that pole beams could be used structurally. Pole beams are used to in each column assembly from the concrete column base to the roof. Doubling the columns gives the column an aesthetic strength for the building occupants, and with the addition of steel components, safeguards the system with structural redundancy. Standard hex connections with knife plates allow the beams (now columns) to be used in a different application in the future.

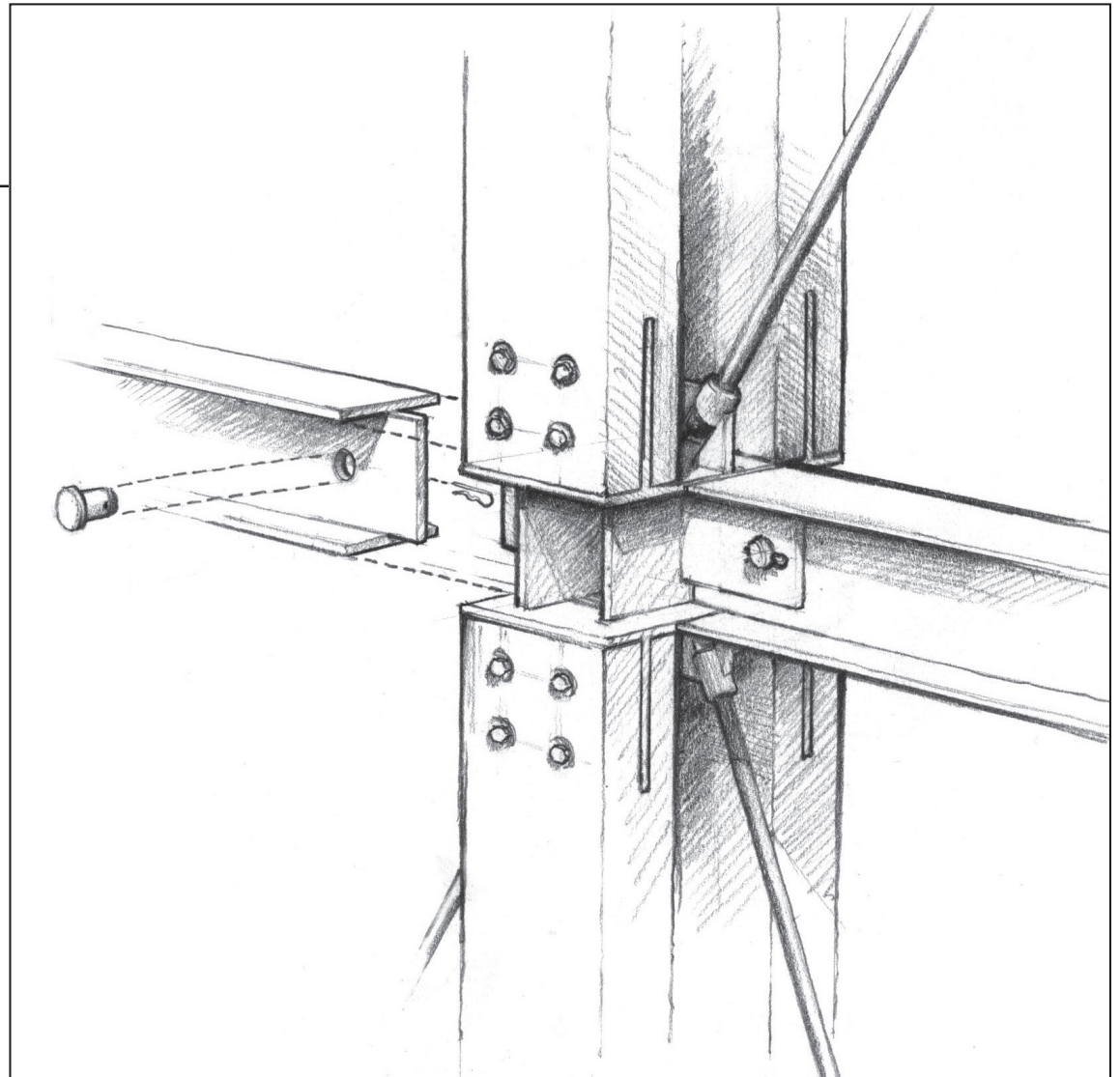

COLUMN ASSEMBLY

Figures 63 and 64. Axon of pole beams and their repurposing as the vertical members in the column assembly.

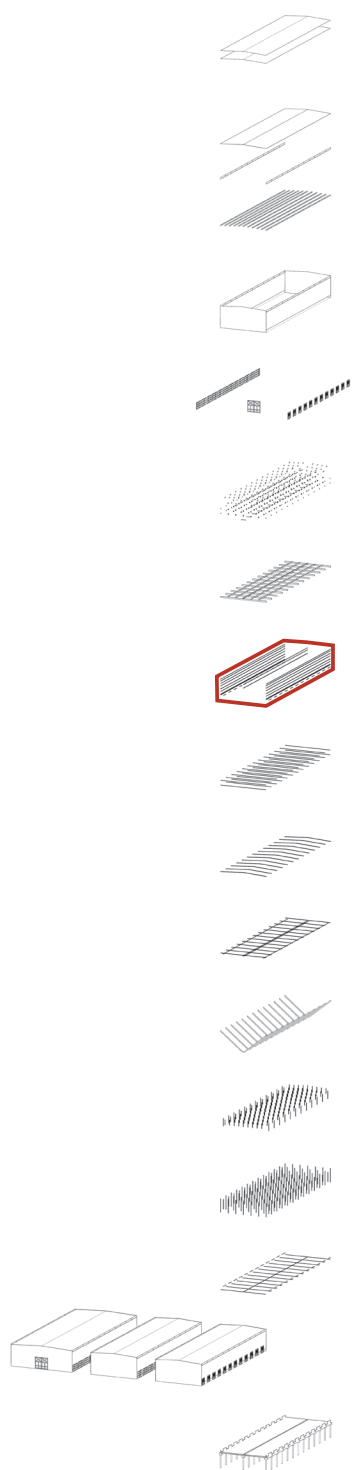

GIRTS

3"X6"X6'

Six-foot boards are rarely salvaged from construction projects. These boards, however, are full-dimensioned 3"x6," which is a common thickness for solid stair treads. Because there are 1,400 of these boards over 6' long (boards under six feet will be incinerated as fuel), their sheer quantity is an opportunity for a repetitive fabrication process.

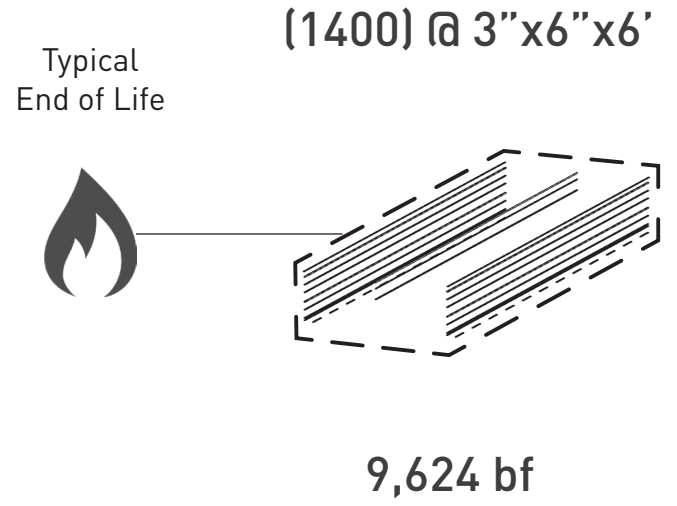

REUSE APPLICATION

Two of these girts can be assembled to make a 6-foot wide stair tread or bridgewalk. By wrapping them with flatbar and attaching brackets, they effectively become a module and can easily be attached to standard stringers with 4 bolts. Now with a rigid steel edge to reduce wear, the stairs will be used again and again, occasionally using new bolts if the threads wear down.

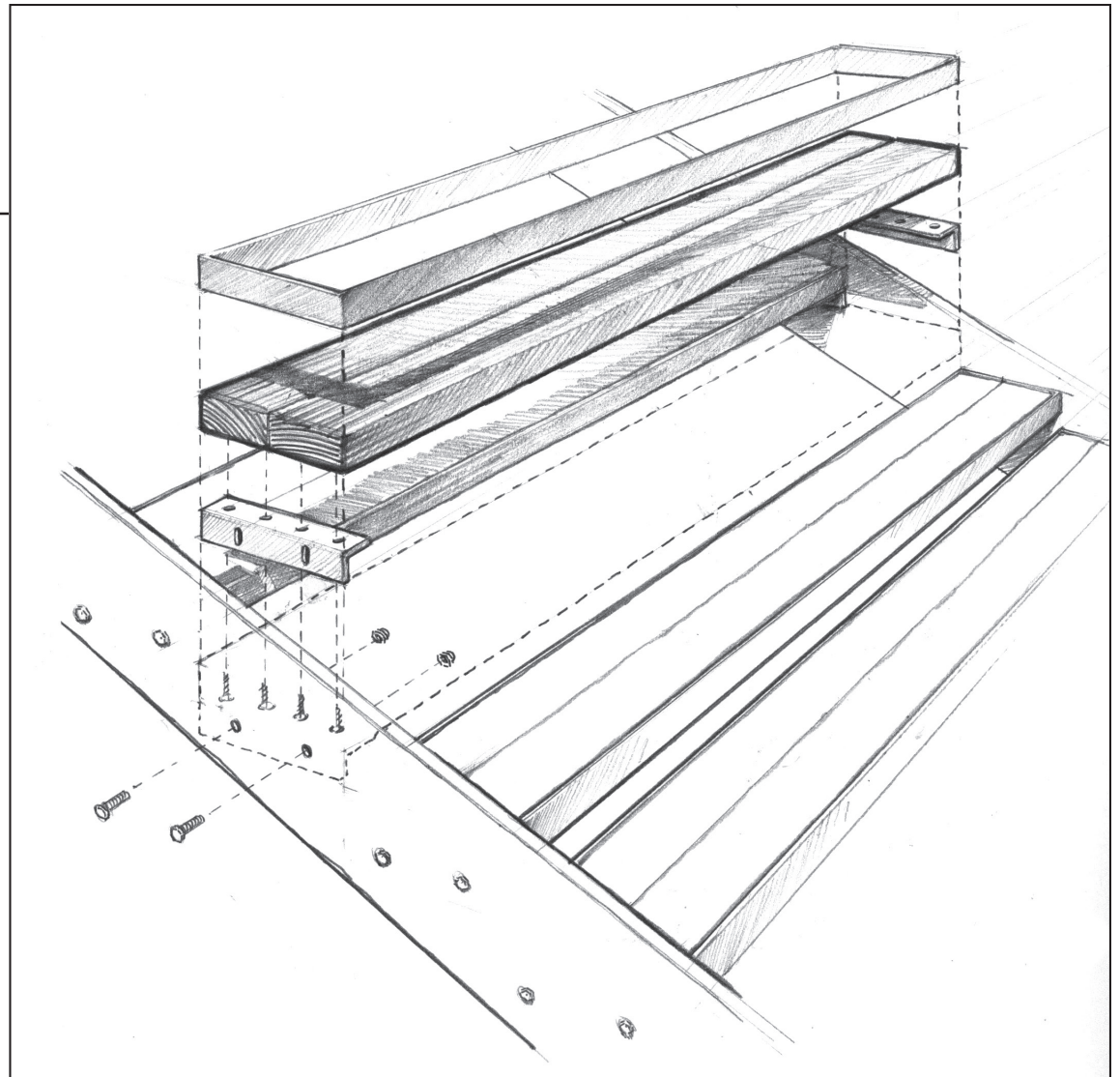

STAIR TREAD ASSEMBLY

Figures 65 and 66. Axon of 6-foot girts and their repurposing as the stair tread assemblies.

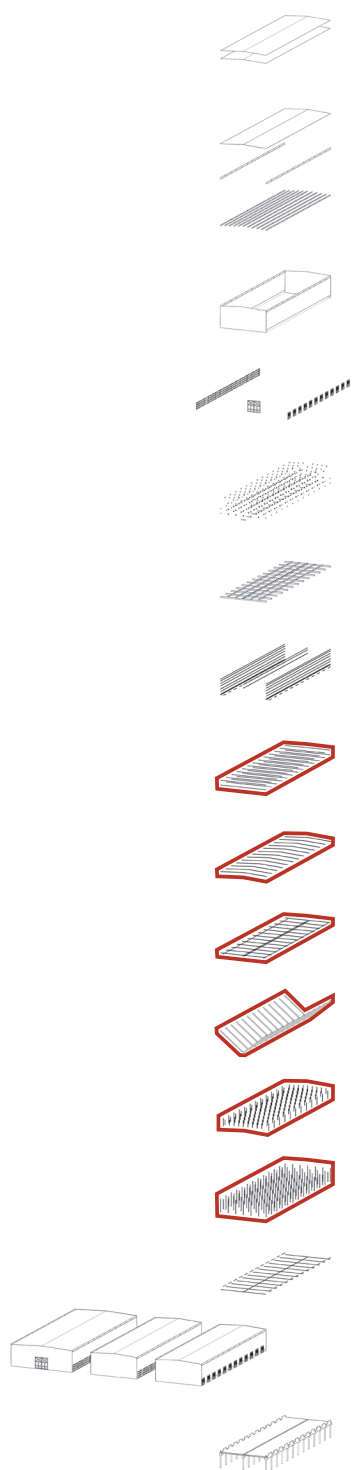

PLATES BRACES STUDS POSTS

This proposal presented the challenge that, if these materials weren't directly reused for this project, it would be too costly to store them and their end of life would be incineration. Many of the long boards would be ill-suited as structural members. By ripping the 4x8 posts and remaining girts in half and using the 2x8 boards at standardized lengths, these boards were enough to wrap the entire building spaced at 9"OC.

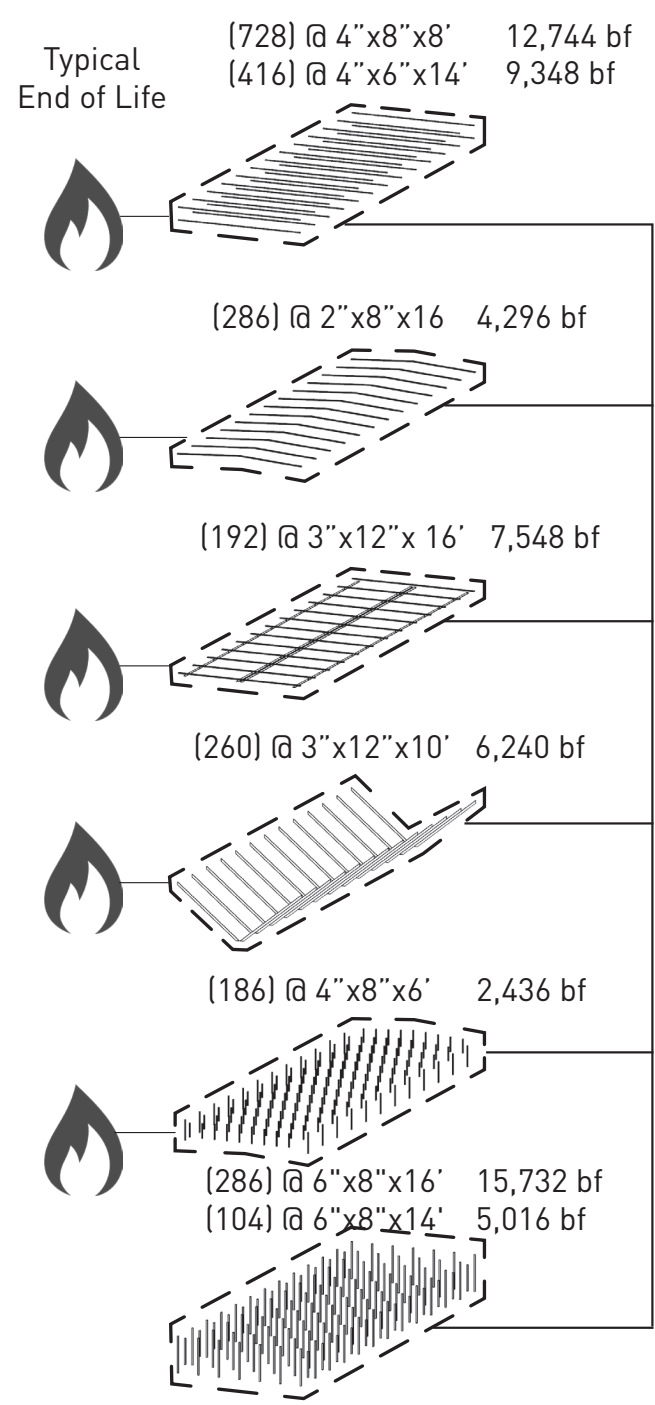

REUSE APPLICATION

The new glazing introduced for the floating volumes does not use the louvers. Research and Development (no louvers) covers nearly the entire North face of the building, so the ubiquitous shading system is not completely superfluous as it wraps the North wall. Only two short sections are actually “unnecessarily” added. However, although they are not needed, they represent an opportunity to store the materials for a future use. This building acts as a warehouse for these “extra” louvers.

The 3x12s are used as stiffeners, with aluminum extrusions to hold the glazing. The 2x8 louvers are mounted to steel angles which span between the stiffener saddles. At each floor height, brackets connect the stiffeners to the main structural system, 6x8 posts which are used in a similar application in the old and new buildings.

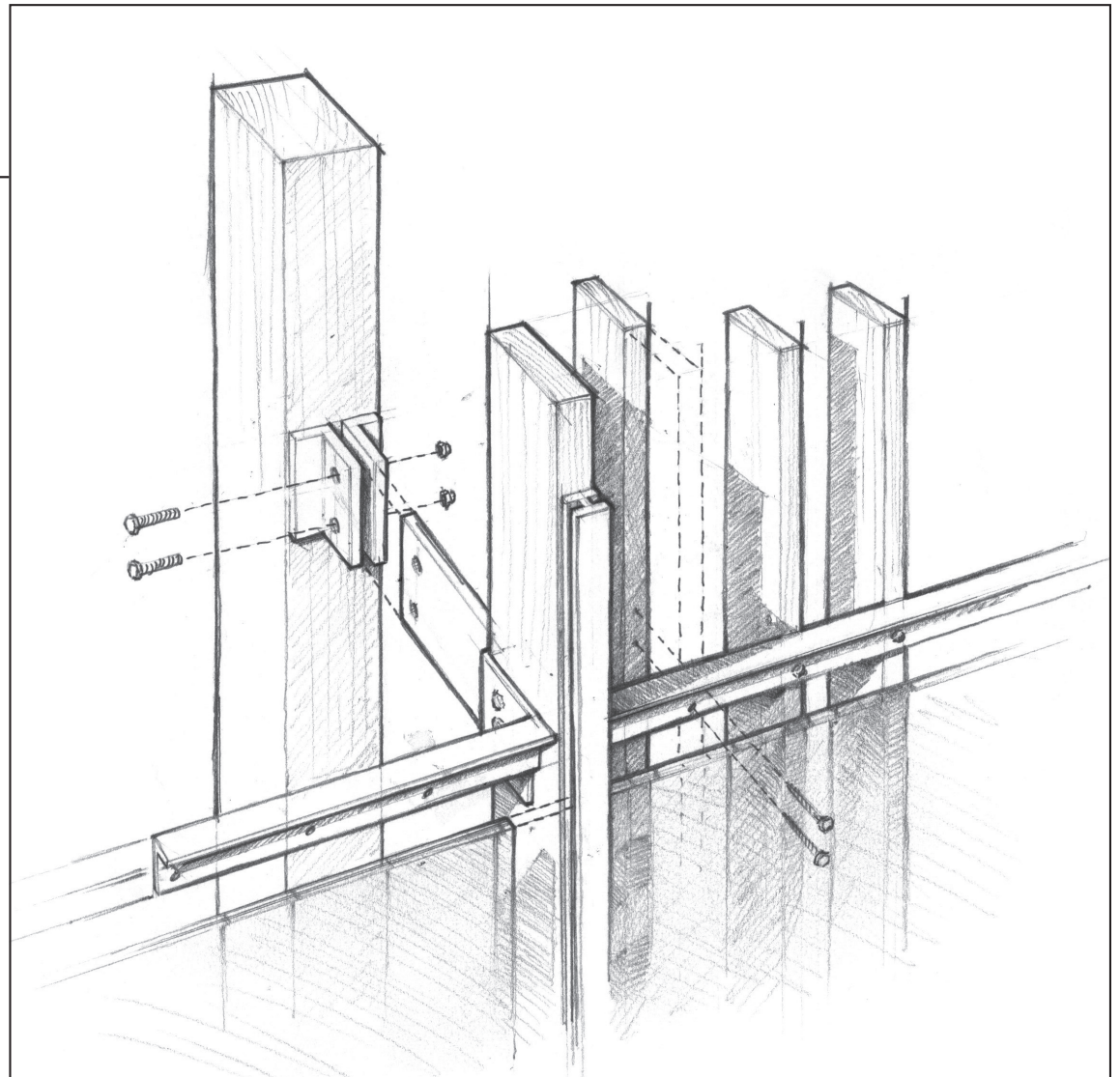

FACADE ASSEMBLY

Figures 67 and 68. Axon of various structural elements and their repurposing as the facade assembly.

ARRANGEMENT OF PROGRAM

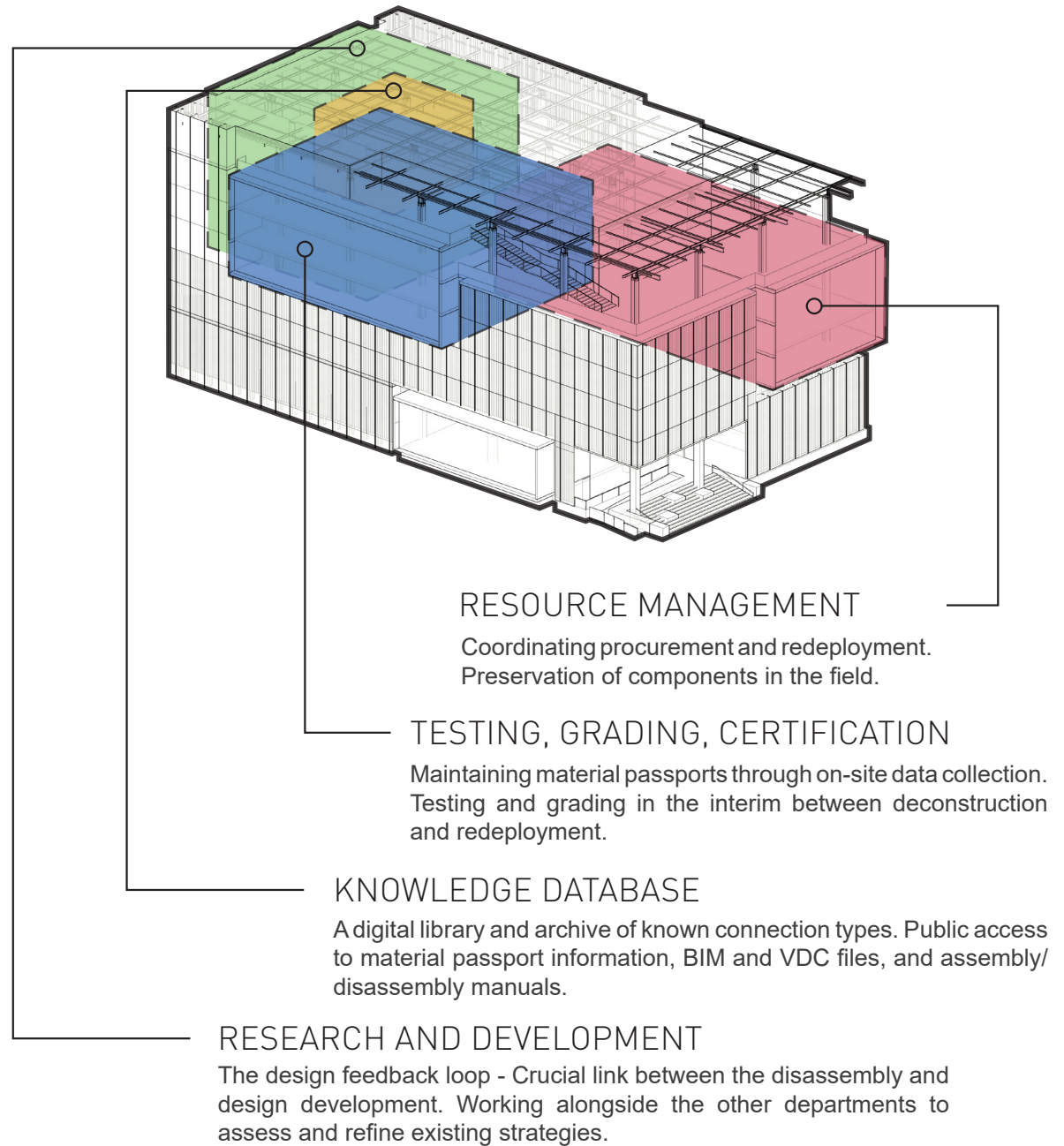

Figure 69 identifies the four main departments as program-defined volumes floating within the main building structure. Other program is in the interstitial spaces between these volumes and is more flexible.

PROGRAM AND SPATIAL DESIGN

PUBLIC SPACE

Aside from the four office divisions identified in Figure 69, most of the commercial building is open to the public and leasable work space. Working together is crucial for mitigating the imminent environmental disasters we face, and the values of a DfD industry operate on that same principle. The ground level of the building is publicly accessible, encouraging community involvement and the utilization of the resources there. A library and computer stations are open to the public, and representatives from each department are available to aid in research and for basic consulting. Public exposure and involvement can lead to wider adoption of DfD, reinforcing its need and the business opportunities therein.

A community workshop and presentation room bookend the main level, and small meeting rooms can be reserved for professional and informal conferences. The main court is a flexible space where large installations and demonstrations can be done, and where public events can be held. Its position in the building allows it to be seen from all office spaces, mezzanines, and the indoor balconies. It is a central gathering point for the building, encourages multi-discipline interaction.

Between the four enclosed departments, the mezzanines occupy the rest of the building volume. They are open-plan commercial spaces, and accommodate spillover from other offices. Inherently flexible, these floor plates can be outfitted with flexible partitions and desks can be configured freely. Depending on the building's occupancy, space on the mezzanines can be rented by companies. Other opportunities for public use is a hot-desking approach, where new (or familiar) desks are assigned to users daily based on preference. Sharing the space and

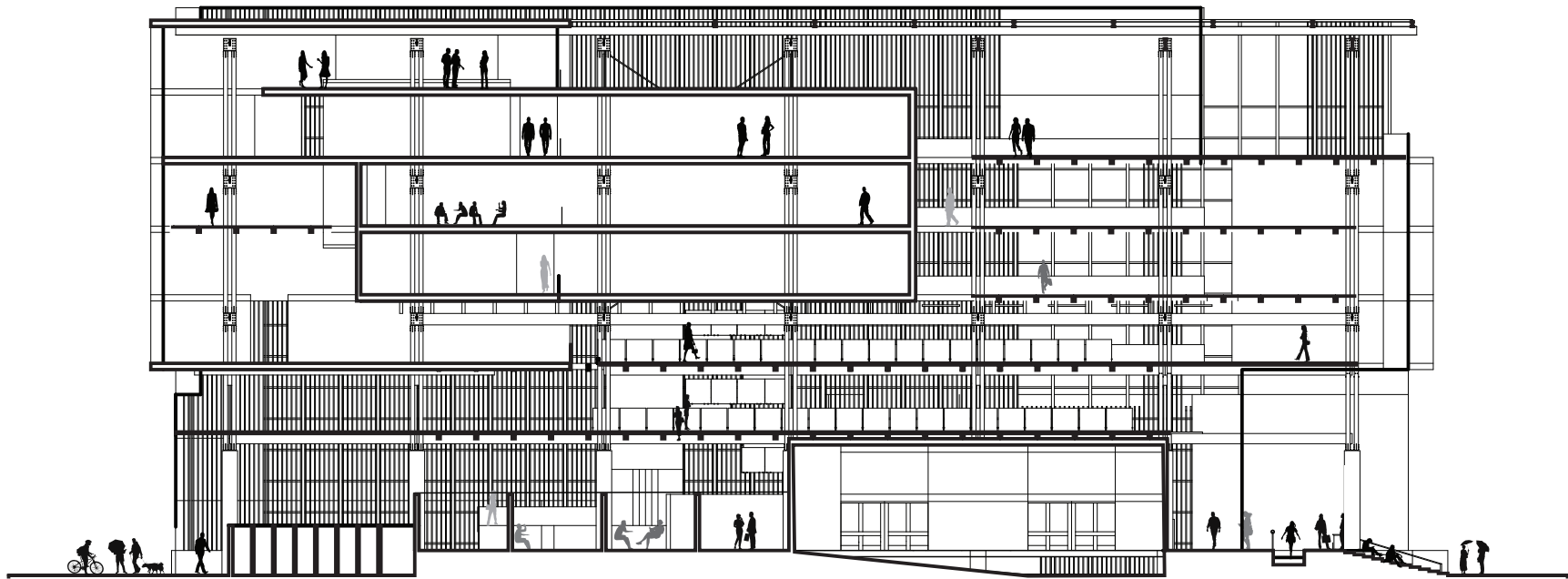

Figure 70: Section A-A. The building's spatial design is focused around the center court. Conceptually, the reclaimed timber structure supports the growth of new commercial space. In the same vein, the knowledge database is located within the research and development offices, acknowledging that in construction, where incremental advancements trump giant disconnected leaps in progress, learned knowledge is always at the core of evolving technology.

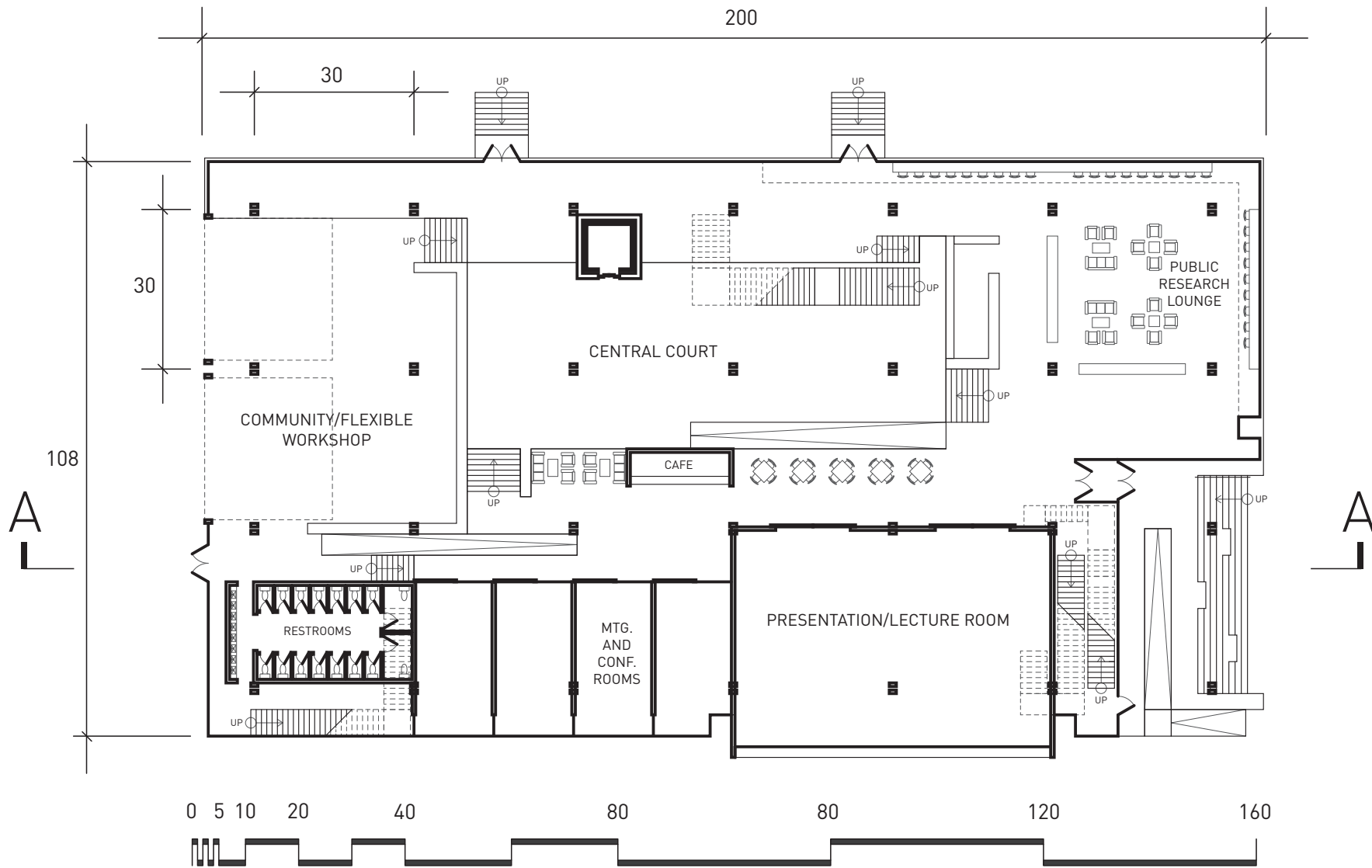

Figure 71. Ground Level Plan

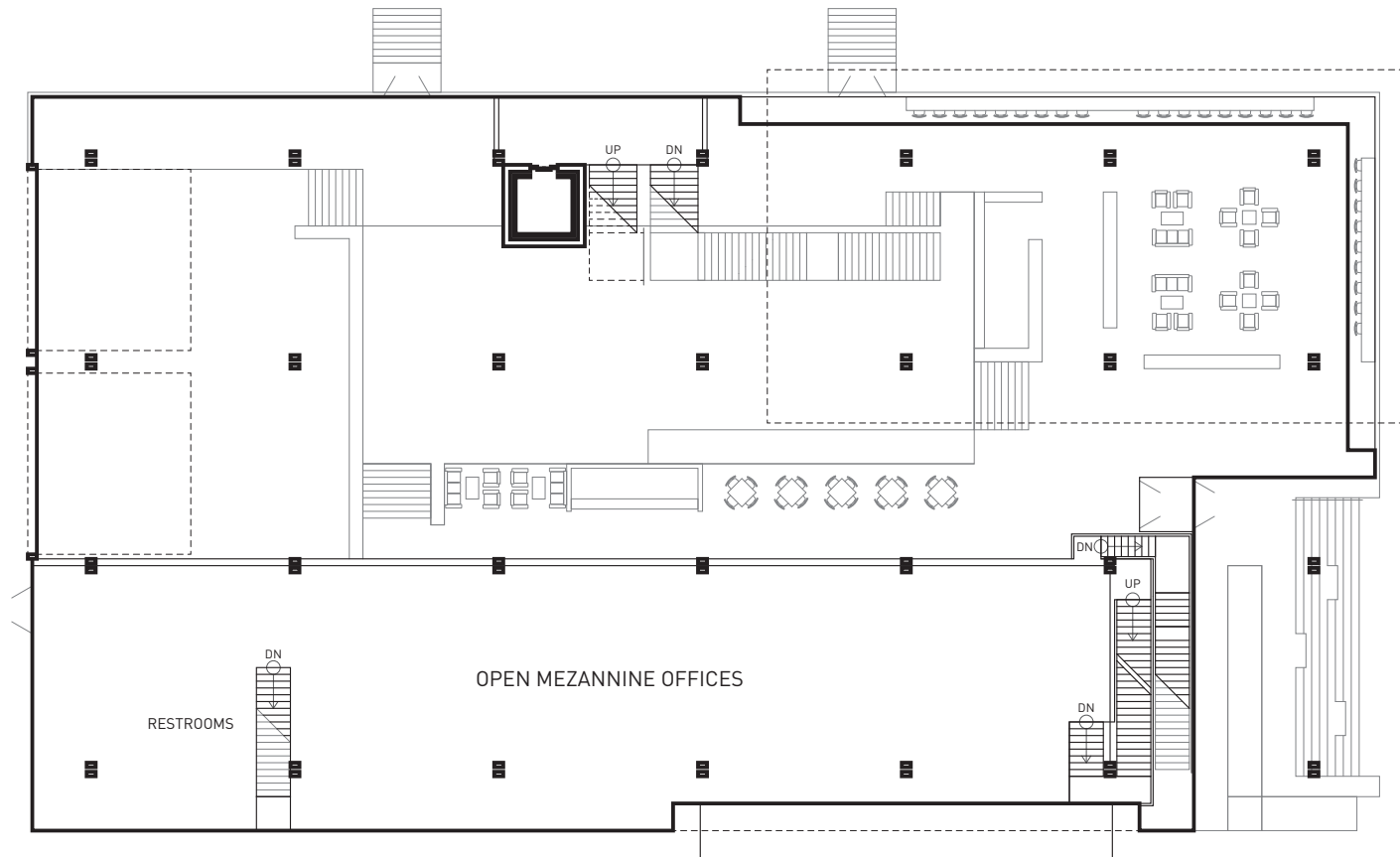

Figure 72. Level 2 Plan

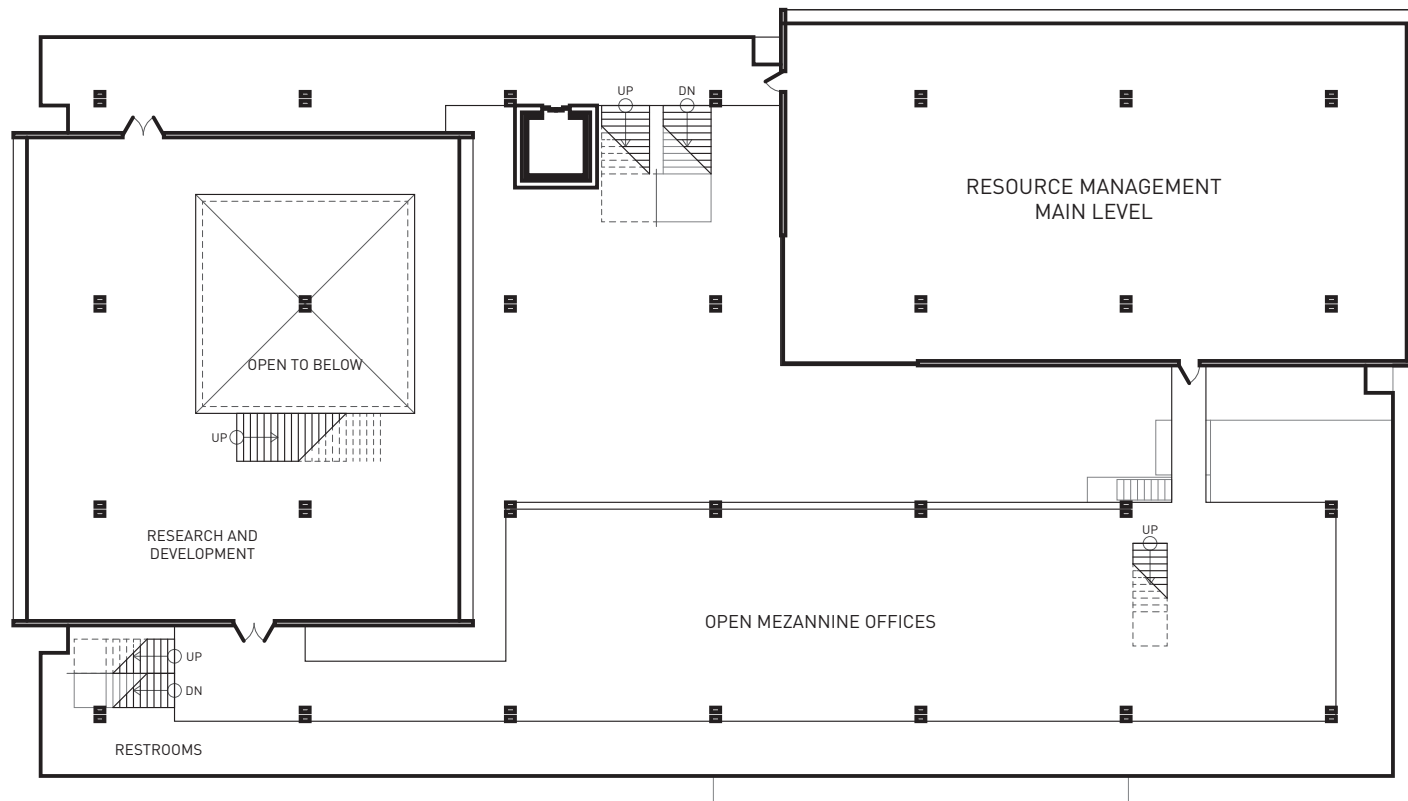

Figure 73. Level 3 Plan

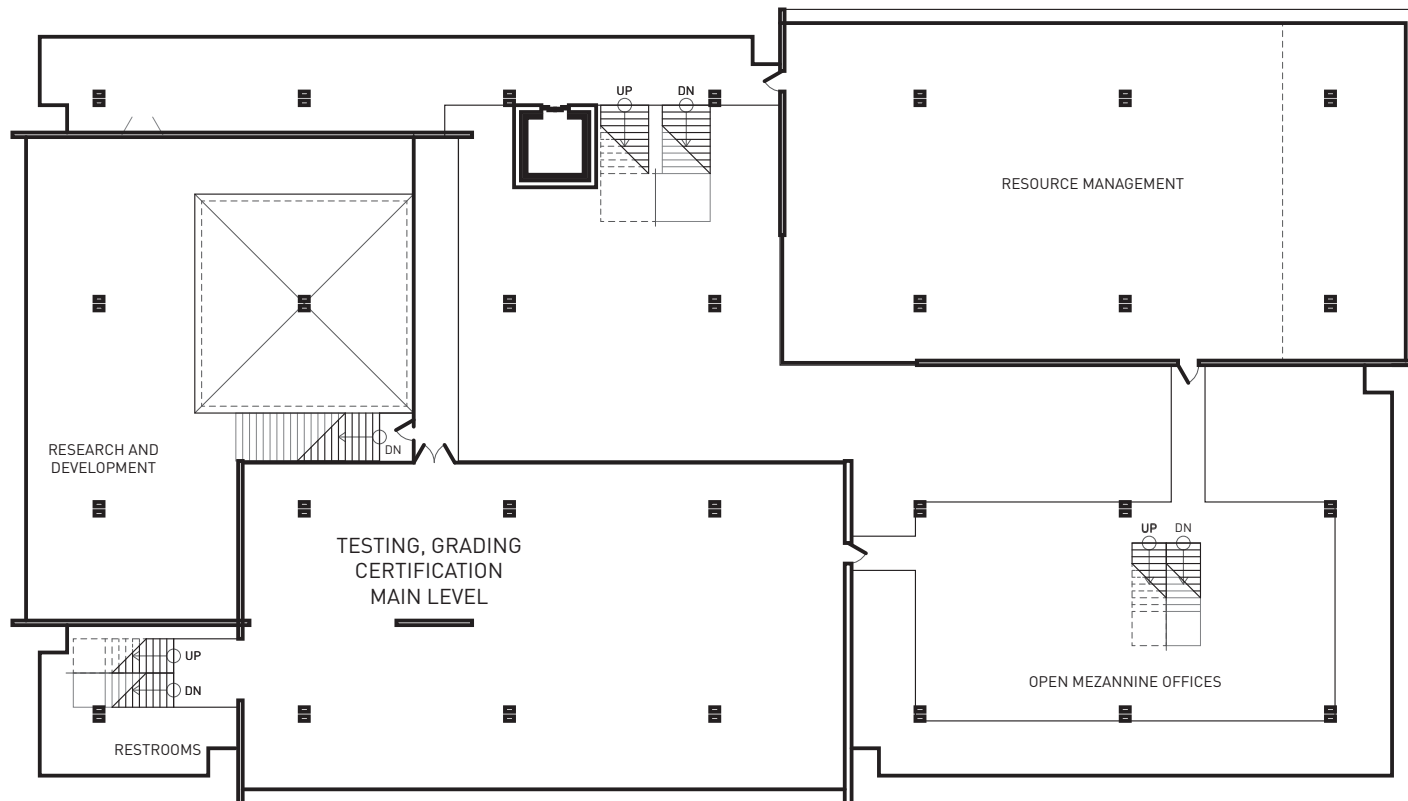

Figure 74. Level 4 Plan

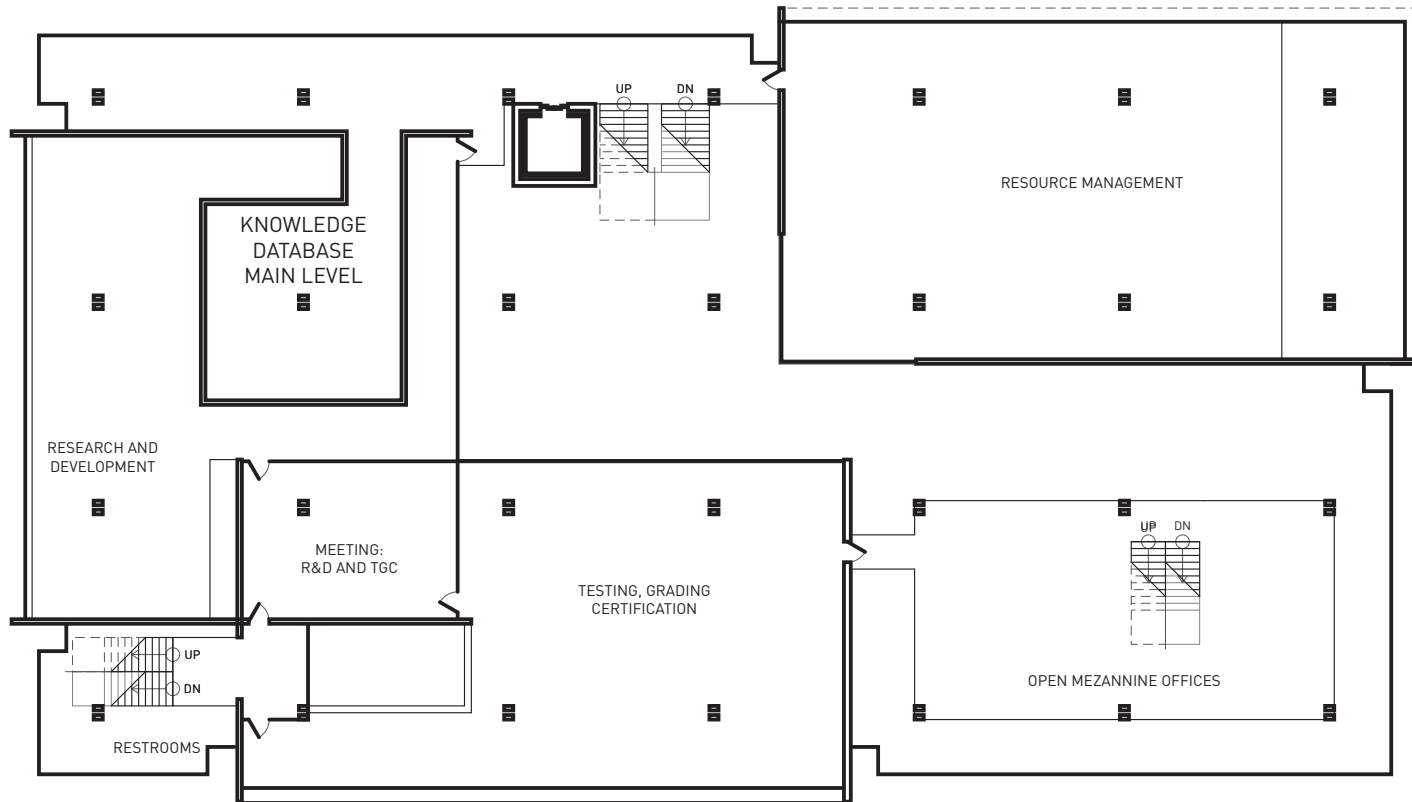

Figure 75. Level 5 Plan

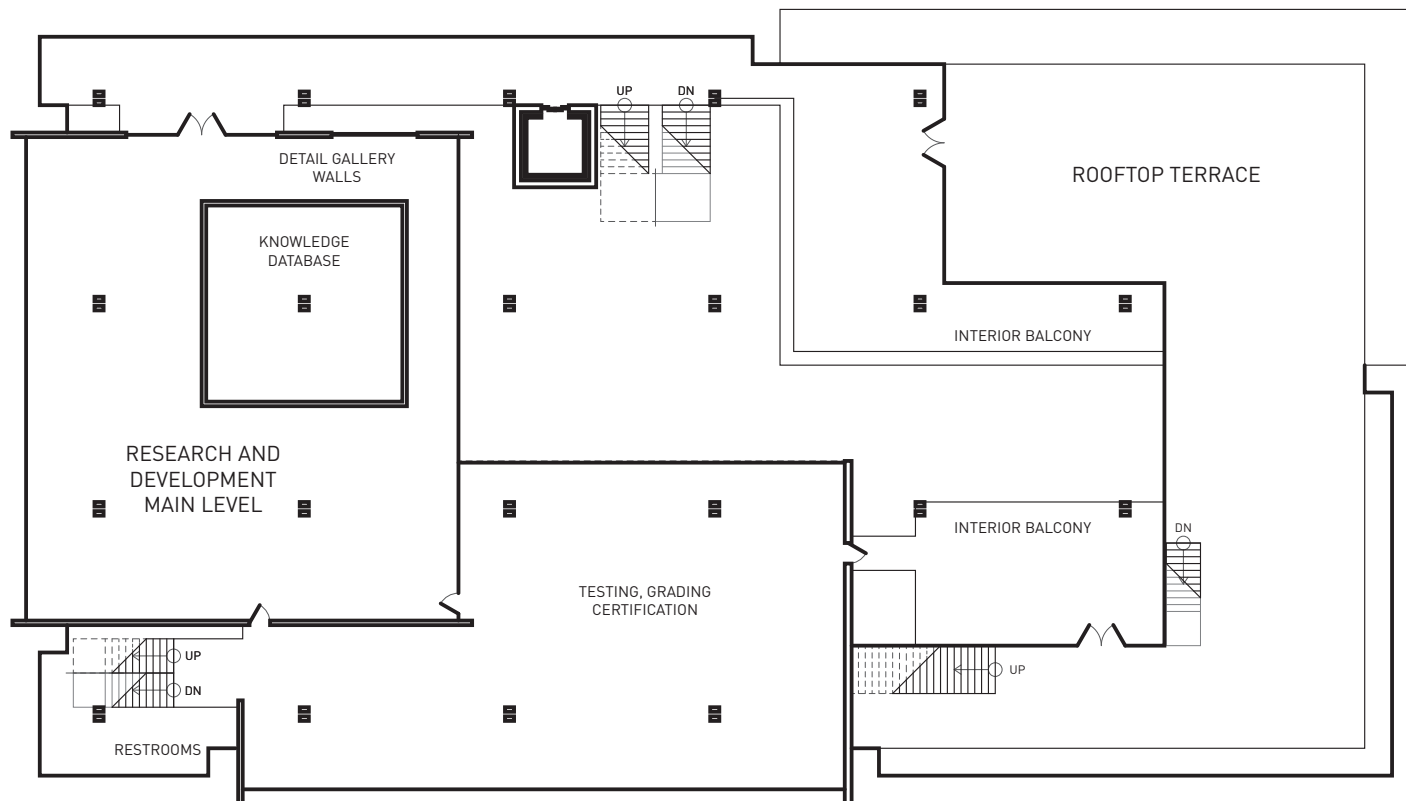

Figure 76. Level 6 Plan

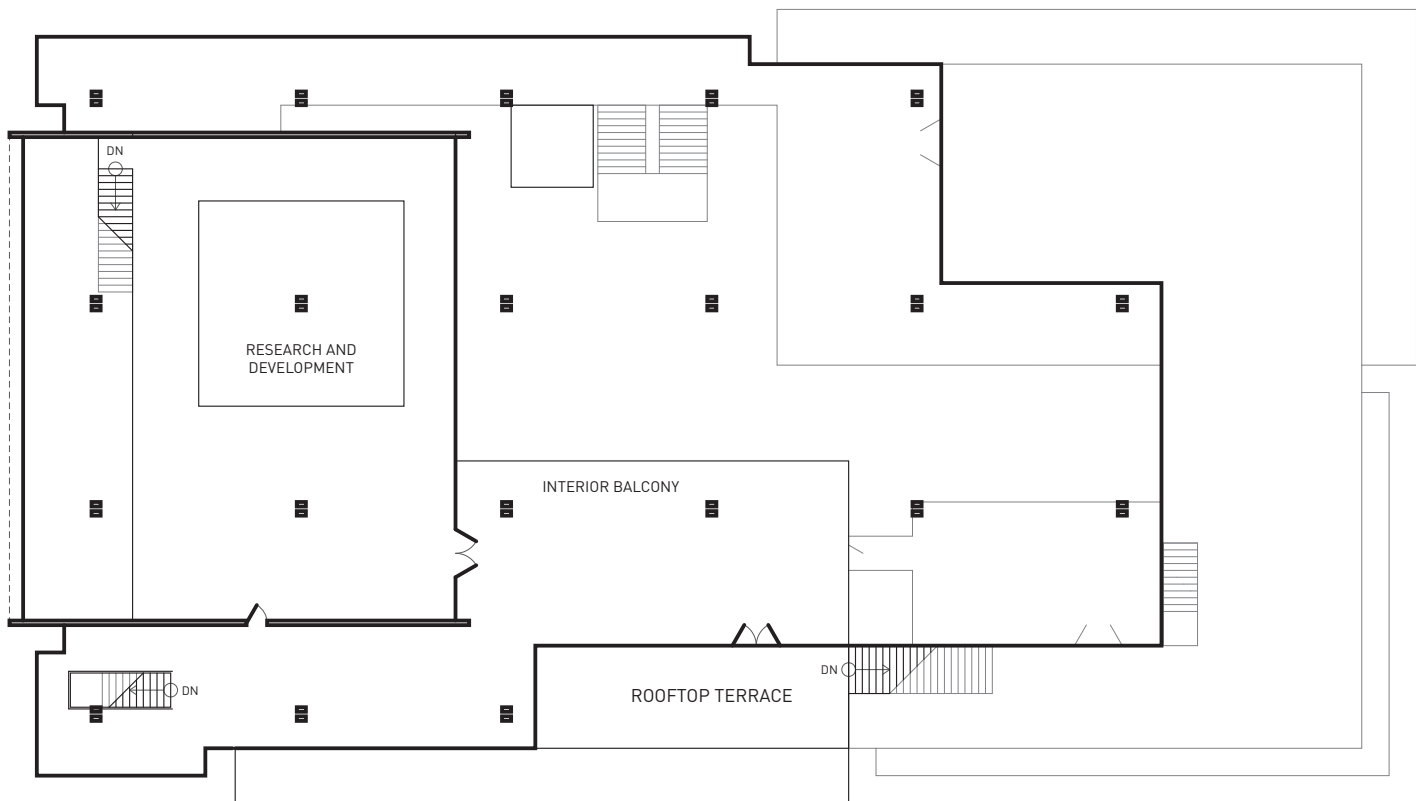
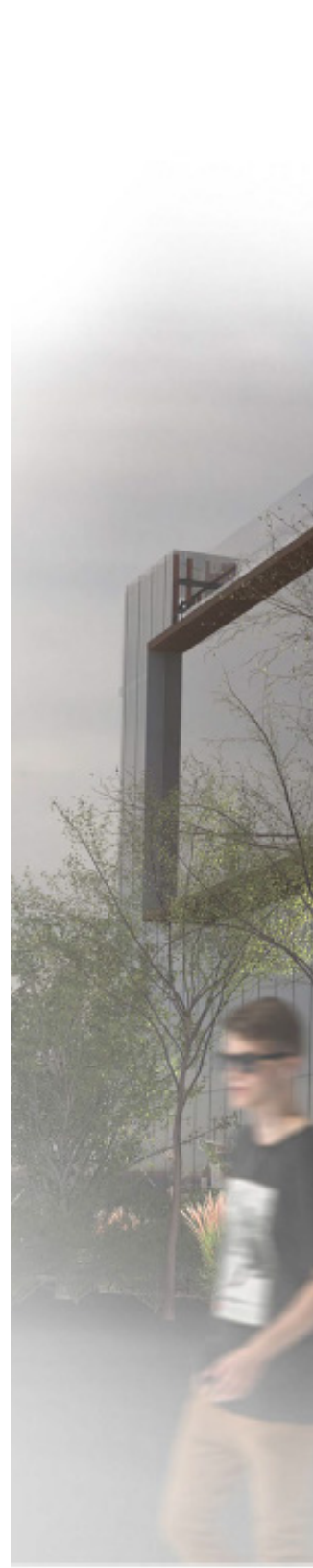

Figure 77. Level 7 Plan

ILLUSTRATING DFD

Figure 78. “The Face of Change,” illustrating facade replacement. Buildings can last longer if they have the flexibility to be changed. A facade can be redesigned when it goes out of style or begins to fail.



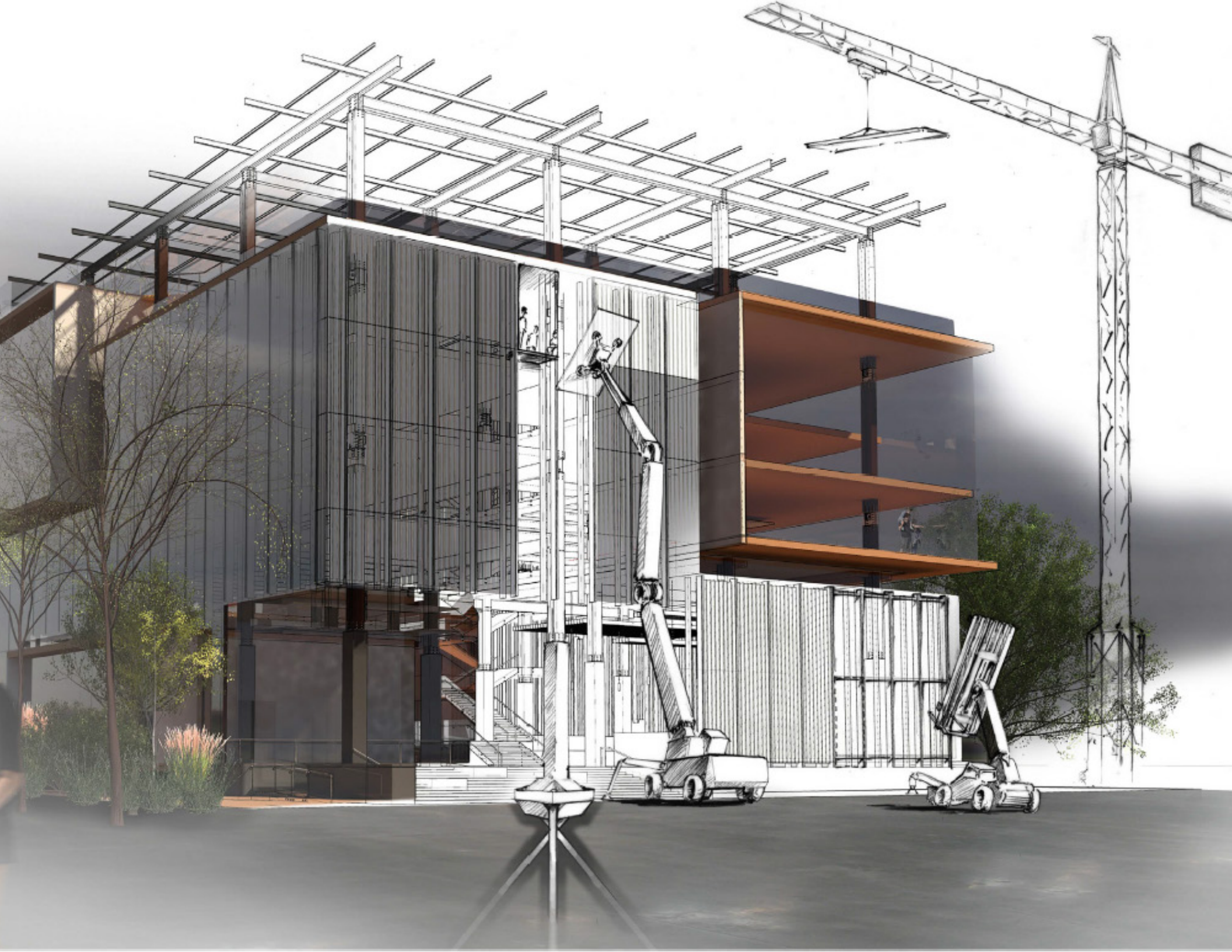

Figure 79. "Platform for Flexibility." Reimagining Foundation Systems. Foundations can be designed as systems that can be reconfigured and then extracted at the building's end of life.



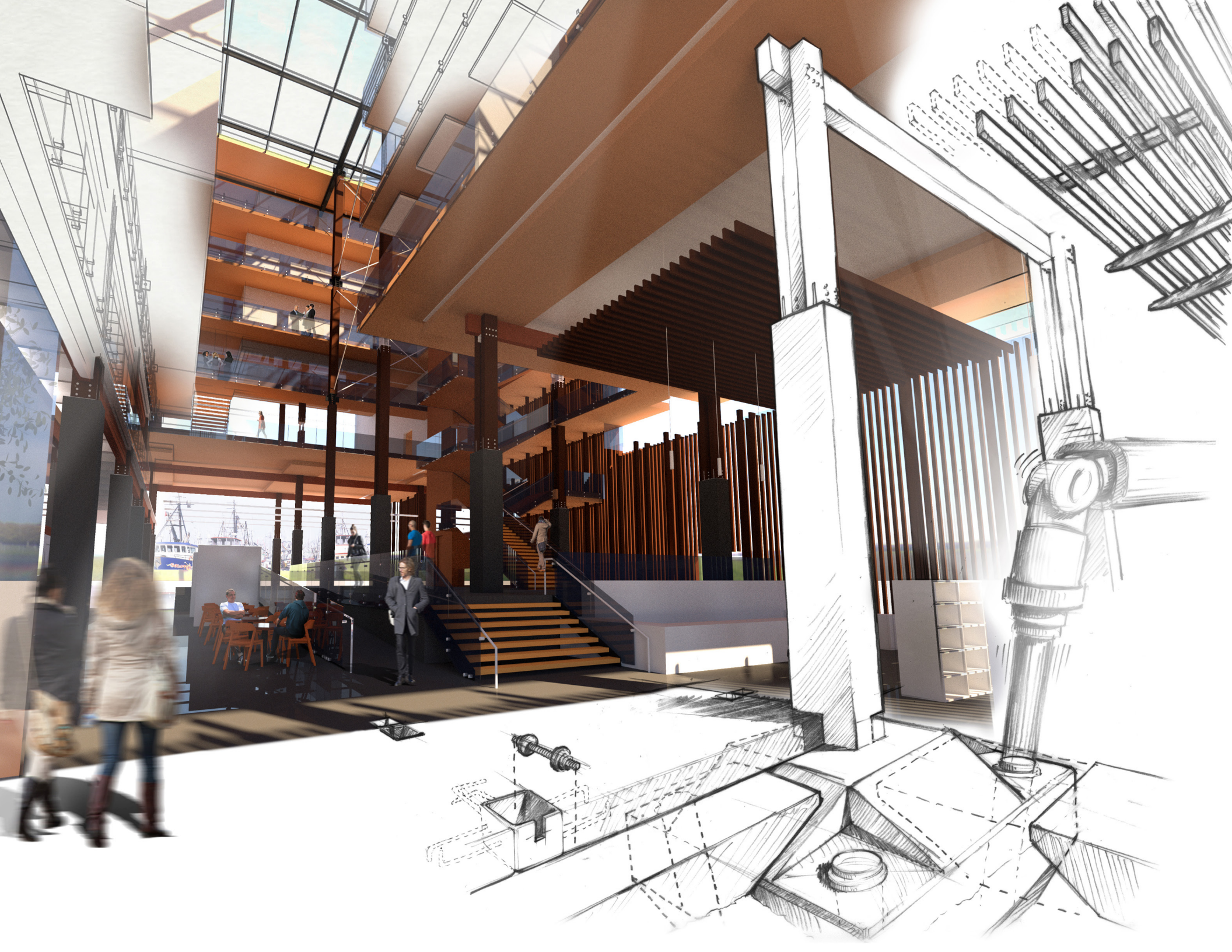

Figure 80. "Exposing the System." Office Interior illustrating the mechanical Connection Walls. Mechanical systems must be flexible and accessible, so when they fail the old systems can be replaced.





CHAPTER 5: CONCLUSIONS AND RECOMMENDATIONS REPURPOSING AND ANTICIPATING THE OBSOLETE

This thesis illuminates the reality of our societal myopia. We build now in a way that sacrifices the future of our successors and the environment. Long have environmental advocates struggled to convince the world that we must act now as if we will have a direct impact on our children's lives, seeking to empathize with future inhabitants of the world we now desecrate.

This thesis contends that the case cannot be made for an alternative without acknowledging the reality that cost and profit are the bottom line. Immediate necessity and immediate gain dictate our decisions. We also can recognize now, especially for companies and building owners that hold their assets for more than a few decades, that there is value in safeguarding assets for at least that long. There is a viable approach to changing our industry, based on appealing to profiteers on a decadal scale that we can envision and will live to see. Morality is not enough – values must be sold.

The design proposal puts forth one of a series of reuse opportunities. Old materials are salvaged and safeguarded against the obsolescence of their next use. Buildings are composed of materials that will outlast them many times over, and should be assembled with connections



Figure 81. "Change at Fisherman's Terminal."



appropriate to their resilience. If we can recover cost by extracting building components, then we can “sell” this new methodology to the industry, and in doing so act as stewards to the environment.

Transitioning to an alternative model presents opportunities for business creation. Increased skilled and unskilled labor for deconstruction, management of archived information, resource management, testing materials, and improving on-site data collection in buildings are among them. As we build the positive case for the alternative, existing businesses will be forced to adapt, just as car companies have nearly all begun designing or producing electric vehicles, and oil companies are investing in alternative energy.

The future is only bleak if that’s how we see it. Architects are uniquely positioned to cast lasting changes into the construction industry, in everything from how we operate our buildings to how we procure raw materials. We must recognize what is within our control, and what is outside it. Our expertise can inform policy that helps materials to flow in perpetuity. Our civilization’s collective conscience is set on immediate gains and fulfilling needs. We can only guide it, we cannot change it. If architecture’s role is to design buildings, we must design the system through which they are delivered and constructed, used and repurposed.

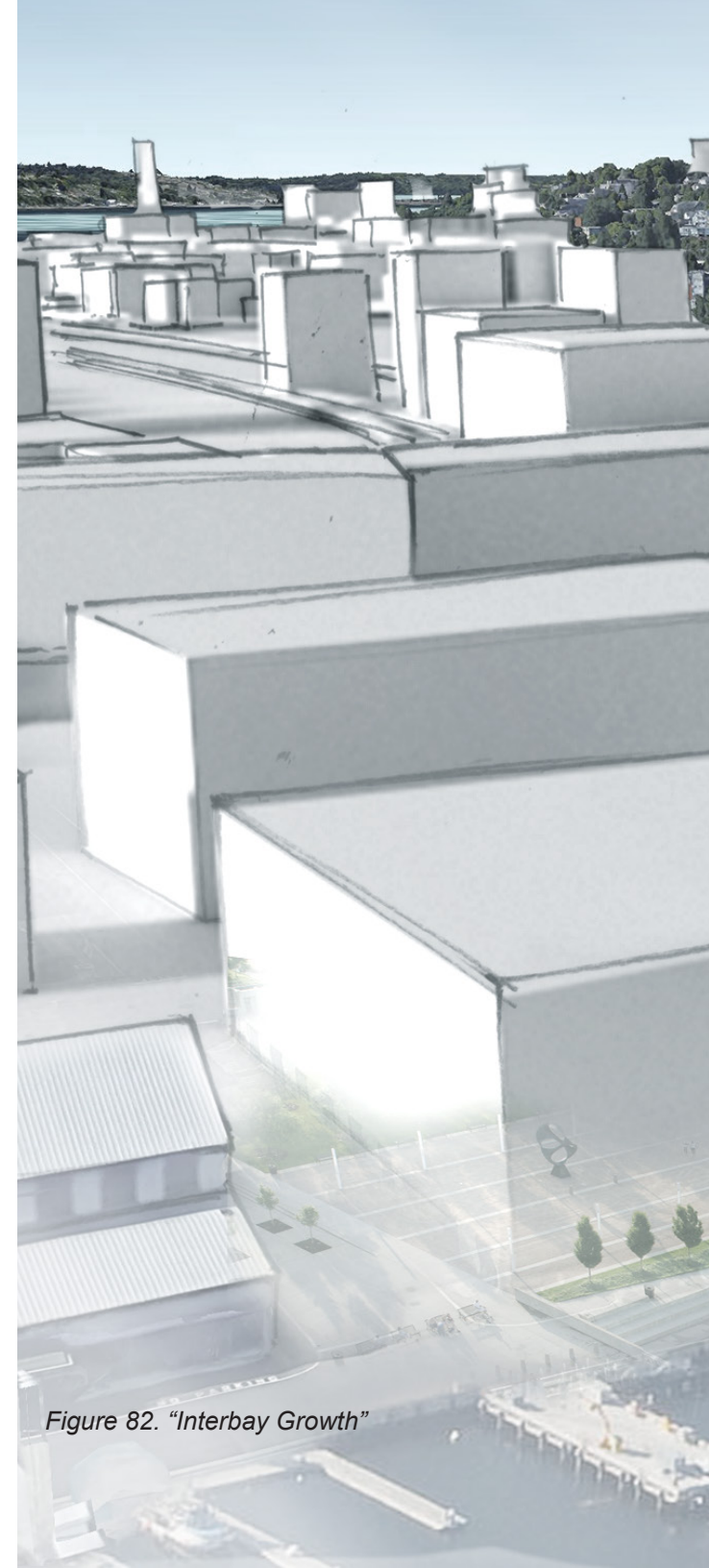
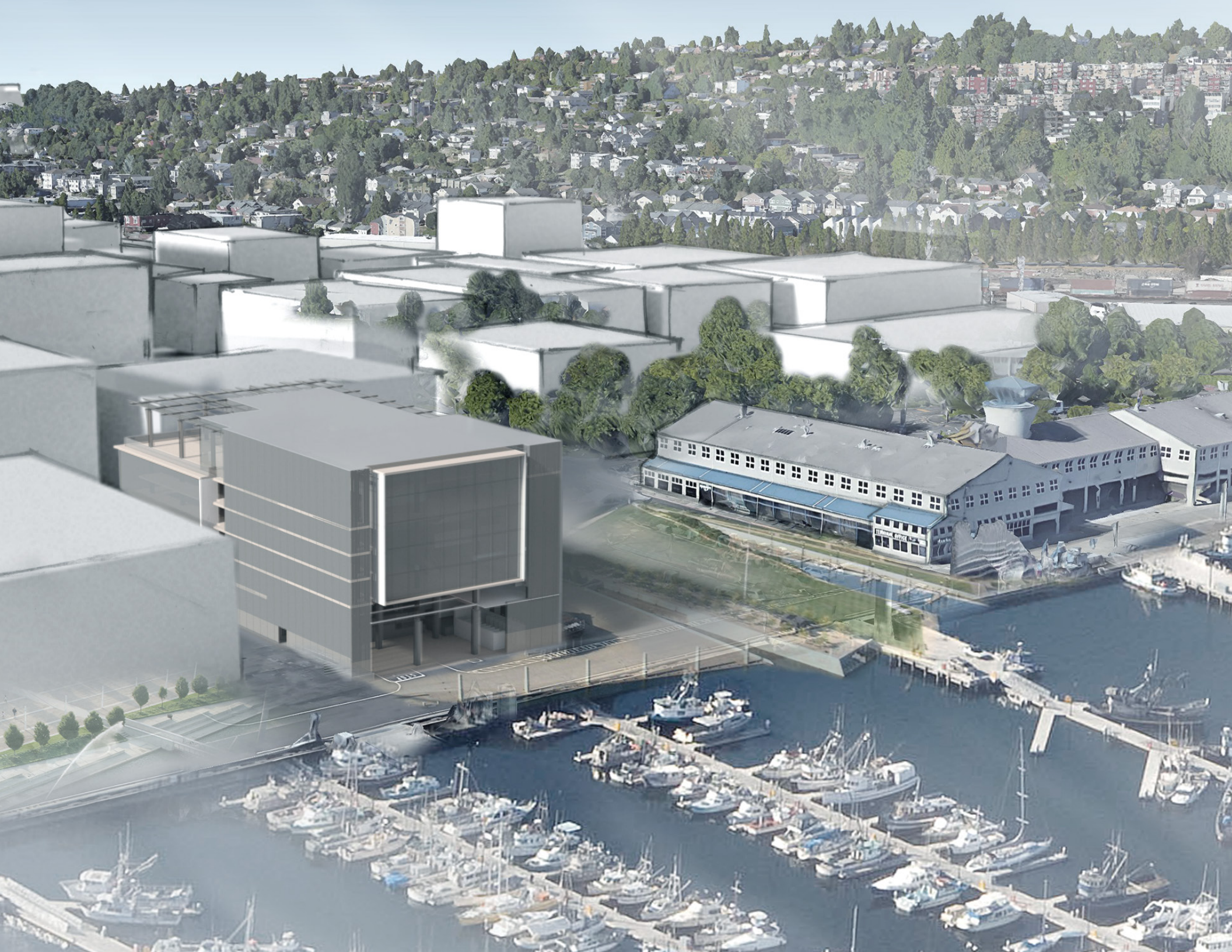

Figure 82. “Interbay Growth”



REFERENCES

1. Durmisevic, Elma. Green design and assembly of buildings and systems: Design for Disassembly a key to Life Cycle Design of buildings and building products. Saarbrücken, Germany: VDM Verlag Dr. Müller Aktiengesellschaft & Co. KG, 2010. Print.
2. Emmer, Michael. Decision Process Model for Closing the Structural Steel Materials Loop in Construction. Diss. University of Florida, 2009. Web. Accessed: 5/11/2017.
3. Kibert, Charles J. "Chapter 11: Closing Materials Loops." Sustainable Construction: Green Building Design and Delivery. New Jersey: John Wiley & Sons, Inc. 2012. Print.
4. Cruz Rios, Fernanda, Chong, Grau. Design for Disassembly and Deconstruction - Challenges and Opportunities. International Conference on Sustainable Design, Engineering and Construction, ASU, Tempe, Arizona, 2015. Unpublished Conference Paper. ScienceDirect. 2017. Print.
5. Soh, S.L., Ong, Nee. Application of Design for Disassembly from a Remanufacturing Perspective. 12th Global Conference on Sustainable Manufacturing, National University of Singapore, 2015. Unpublished Conference Paper. Science Direct. 2017. Print.
6. Vandenbroucke, Mieke, Galle, Temmerman, Dabacker, Paduart. "Using Life Cycle Assessment to Inform Decision-Making for Sustainable Buildings." Buildings. "Life-Cycle Energy Analysis of Buildings" (2015): MDPI Open Access Journals. Web. Accessed: April 8, 2017.
7. Gungor, Askiner. "Evaluation of connection types in design for disassembly (DfD) using analytic network process." Computers and Industrial Engineering.50 (2006): 35-54. Science Direct, Elsevier. Web. Accessed: June 11, 2017.
8. Aggregate. Governing by Design: Architecture, Economy, and Politics in the Twentieth Century. Pittsburgh: University of Pittsburgh Press, 2012. Project MUSE. Web. Accessed: May 5, 2017.
9. Favi, Claudio, Germani, Mandolini, Marconi. Includes knowledge of dismantling centers in the early design phase: A knowledge-based design for disassembly approach. 23rd CIRP Conference on Life Cycle Engineering, Università Politecnica delle Marche, Ancona, Italy, 2016. Unpublished Conference Paper. Science Direct, Elsevier, Web. Accessed: 2017.
10. Hazelhurst, Hamilton. "SLU Discovery Center: Developer Perspective." Interview by William G. Wheaton. Oct. 20, 2016.
11. Franklin, Bill. "SLU Discovery Center: Architect Perspective." Interview by William G. Wheaton. Dec 2, 2016.
12. Taylor, Jay. "SLU Discovery Center: Engineer Perspective." Interview by William G. Wheaton. Dec 2, 2016.
13. Dejarlais, Bill. "SLU Discovery Center: Contractor Perspective." Interview by William G. Wheaton. Dec 28, 2016.
14. Wright, Ron. "Pioneer Square Pergola Reconstruction: Architect Perspective" Interview by William G. Wheaton. May 15, 2017.
15. Brand, Stewart. *How Buildings Learn: What Happens After They're Built*. New York: Penguin Books, 1994. Print.
16. DEGW Official Website. Architectural Space Planners. The Useful Arts Organization. Web. Accessed: June 11, 2017.
17. O'Neill, Robert V. *A Hierarchical Concept of Ecosystems*. Princeton, NJ: Princeton University Press, 1986.
18. Kibert, Charles J., Sendzimer, Guy. Construction ecology and metabolism. Conference Proceedings CIB TG 39, Germany, 2002.
19. Whitehill, Walter M. "Promoted to Glory... The Origin of Preservation in the United States." *With Heritage So Rich, National Trust for Historic Preservation*. New York: Random House, 1966.
20. McDonough, William, Braungart, Michael. *The Upcycle: Beyond Sustainability - Designing for Abundance*. New York, North Point Press, 2013. Print.
21. McDonough, William. "Cradle to Cradle Design." TED2005: Inspired By Nature. Monterey, CA. Feb. 25, 2005. Lecture
22. Simonen, Kathrina. *Life Cycle Assessment*. New York: Routledge, 2014.
23. Geyer, R., Kuczenski, B., Zink, T. and Henderson, A. (2016), Common Misconceptions about Recycling. *Journal of Industrial Ecology*, 20: 1010–1017. doi: 10.1111/jiec.12355
24. White, A., Soughton, M., Feng, L., "Servicizing: The Quiet Transition to Extended Product Responsibility." May 1999. OECD Workshop on Extended and Shared Responsibility for Products: Economic Efficiency/Environmental Effectiveness. Washington D.C.: Dec. 1-3, 1998. Web. Accessed: 6.15.17.
26. Discover South Lake Union. <http://www.discover slu.com>. Metric Media. Web. Accessed: May 3, 2017.
27. Morgan, Murray (1960). *Skid Road: Seattle, Her First Hundred Years*. Ballantine Books. pp. 6–7. ISBN 0-345-24310-2.
28. Kreisman, Lawrence. *Made to Last, Historic Preservation in Seattle*. Seattle: Historic Preservation Foundation and University of Washington Press, 1999.
29. Prideaux-Mooney, Ailsa, "The Endangered Pergola of Pioneer Square," Website Blog, Where's My Backpack, Wordpress, January 14, 2015.
30. Municipal Tower Archives, Pioneer Square Preservation District. "Iron Pergola"
31. Ochsner, Jeffrey Karl, *Shaping Seattle Architecture: A Historical Guide to the Architects*, University of Washington Press, Seattle and London, 1994.
32. Woolridge and Montgomery, *Architecture in Washington*, 110.
33. Boswell, Sharron, "Saving a Time, and a Place," *The Seattle Times*, Oct. 27, 1996, The Seattle Times Company.
34. Seattle Parks recommended first containing the site with an 8-foot high chain link fence, and washing the structure to expose all its vulnerabilities and visible decay.
35. Stockton, Paysha, "Pergola Rising In Pioneer Square," June 18, 2002, *Seattle Times*
36. Bennett, Sam, "Pergola Defies Modern Methods", April 12, 2001, Source: Unknown, Municipal Tower Archives, Pioneer Square Pergola
37. Sommer, John and Jensen, Kasper Guldager. *Building A Circular Future*. Copenhagen, Denmark: KLS PurePrint, 2016. Print.
38. Sweet, Kopp, Weaver et al. Global and Regional Sea Level Rise Scenarios for the United States. NOAA Technical Report NOS CO-OPS 083, Silver Spring, Maryland, January 2017. Unpublished Conference Paper. National Oceanic and Atmospheric Administration, U.S. Department of Commerce, 2017. Print.
39. Construction and Demolition (C&D) Materials Scoping Study: Building Materials Reuse Centers. October 2012. Unpublished Conference Paper. U.S. Environmental Protection Agency, Office of Resource Conservation and Recovery. 2017. Print.
40. Trade Data Visualization. World Integrated Trade Solution. The World Bank, September, 2017. Web. December 5, 2017.

LIST OF FIGURES

- 1) Timber Joinery with Treenails
- 2) Riveted Steel Connection
- 3) Concrete Pour and Footing
- 4) Building Demolition
- 5) Cradle to Grave
- 6) Cradle to Cradle
- 7) Material Imports Map
- 8) Waste Diversion and Salvage Assessment
- 9) Ballard Reuse
- 10) Second Use Building Materials
- 11) Earthwise Architectural Salvage
- 12) Transfer Station Sorting - Landfill
- 13) Transfer Station Sorting - Burnables
- 14) When C&D Waste is Generated
- 15) Seattle Waste Volume
- 16) Where Waste Goes
- 17) DCW Compositions
- 18) Periodic Tables - Rates of Depletion and Recycling rates of known resources. 3XN ^[37] Diagram, original from the Ellen MacArthur Foundation.
- 19) Circular Economy - Adapted diagram by 3XN ^[37] Diagram, original from the Ellen MacArthur Foundation.
- 20) Mirra Chair by Herman Miller.
- 21) Open Loop
- 22) Next Forty Years
- 23) Waste Transition Proposal
- 24) S. Lake Union Discovery Center (SLUDC)
- 25) SLUDC Roof Panels
- 26) SLUDC Glazing Gap
- 27) SLUDC Ramp
- 28) SLUDC Moving Sections
- 29) Pergola 1910
- 30) Pergola Shattered
- 31) Pergola Fasteners
- 32) Pergola Mechanical Joints
- 33) Pergola Posts
- 34) Seidelhuber Assembly
- 35) De Fire Styrelser
- 36) VIA Wood Assembly
- 37) VIA Fastener
- 38) VIA Concrete Assembly
- 39) Craned Slab
- 40) Bolted Post and Beam
- 41) MOSA Cladding
- 42) Interbay Aerial
- 43) Interbay Word Map
- 44) Sea Level Rise (SLR) Today
- 45) SLR 2100
- 46) SLR 2170
- 47) Four Divisions
- 48) CLT Procurement 2030
- 49) CLT Material Passport
- 50) CLT Procurement 2060
- 51) Interbay Future Projection
- 52) Interior Frame
- 53) Section Sketch
- 54) Material Axon
- 55) Shed Interior
- 56) Fisherman's Terminal (F.T.) Industry
- 57) Site and Net Sheds
- 58) Basic DfD Assembly Strategies
- 59) Proposed DfD Assembly Strategies
- 60) Old and New
- 61) Tongue and Groove (T&G) Axon
- 62) Mezzanine
- 63) Beams Axon
- 64) Column Assembly
- 65) Girts Axon
- 66) Stair Assembly
- 67) Plates, Braces Axon
- 68) Facade Assembly
- 69) Program Axon
- 70) Section A-A
- 71) Ground Level Plan
- 72) Level 2 Plan
- 73) Level 3 Plan
- 74) Level 4 Plan
- 75) Level 5 Plan
- 76) Level 6 Plan
- 77) Level 7 Plan
- 78) The Face of Change
- 79) Platform for Flexibility
- 80) Exposing the System
- 81) Change at F.T.
- 82) Interbay Growth
- 83) Site Analysis Sketch
- 84) Interbay Bare
- 85) Interbay Developed
- 86) Glacial Silt
- 87) Site Circulation
- 88) Property Lines
- 89) Interbay Businesses
- 90) Marker Plan Development
- 91) Marker Site Aerial
- 92) Plan Development
- 93) Elevation and Section Development
- 94) Layered Building
- 95) Wall Section Sketch

APPENDIX

DESIGN DEVELOPMENT

The following drawings represent a couple of the avenues pursued in the evolution of this thesis. The proposal imagines a fundamentally different way of construction buildings than we do today. Thus, the narrowing of the thesis scope represented a significant portion of the work done. Explorations into the proposal were done at the district, immediate site, building, and detail scales. All of these had a positive impact on the project's resolution, at each scale the investigations revealed more, allowing the issues to be understood in greater depth.

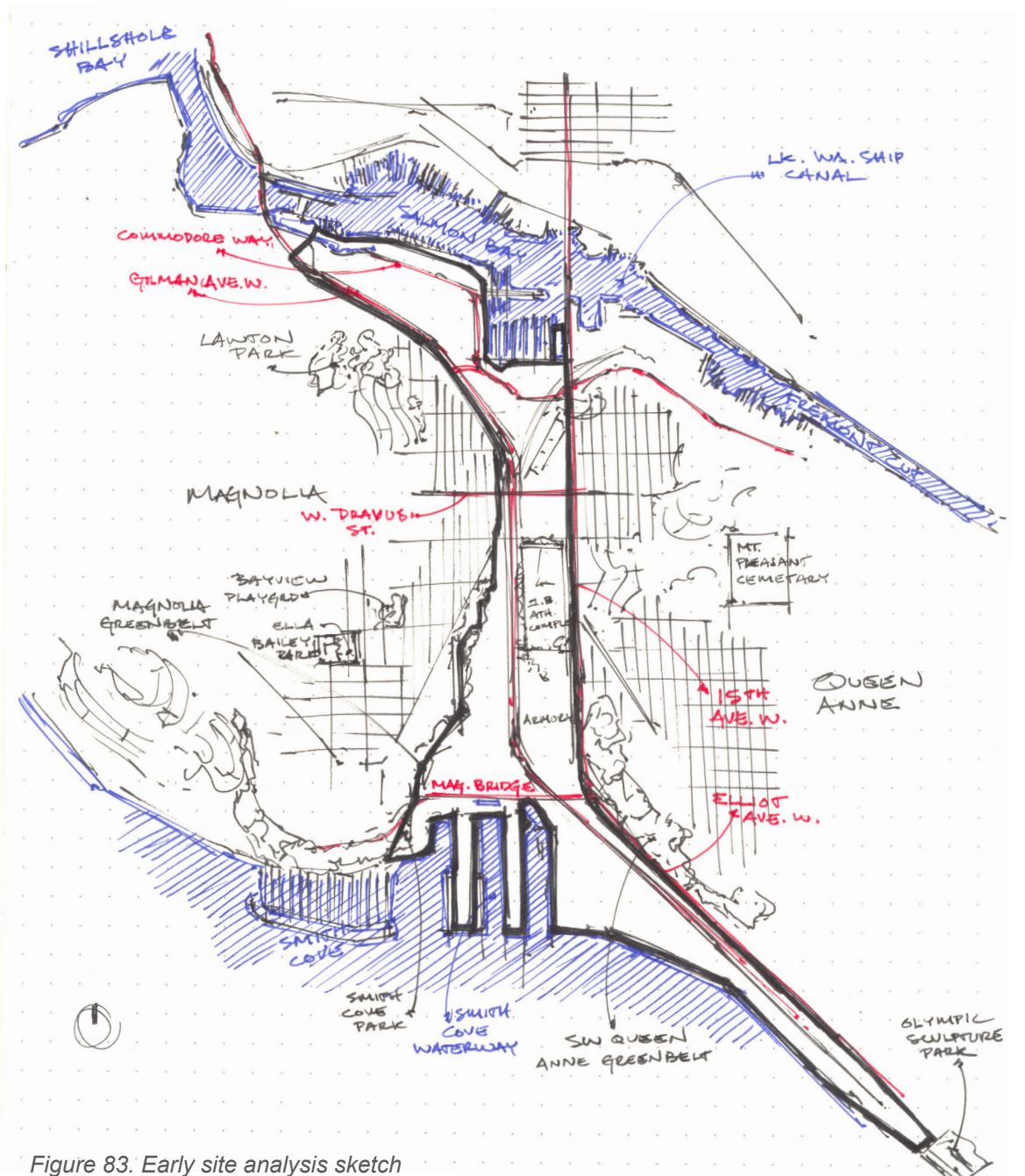
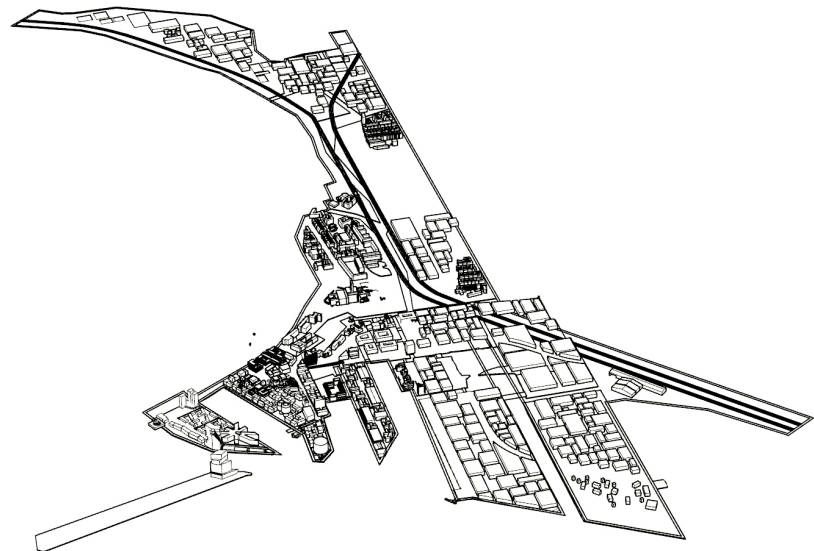
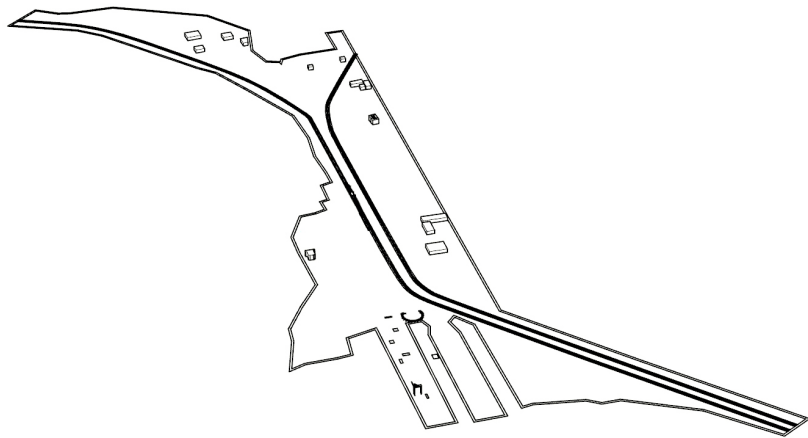

Figure 83. Early site analysis sketch



Figures 84 and 85 show the buildings currently in Interbay (Above) and after a projected zoning change and influx of development.

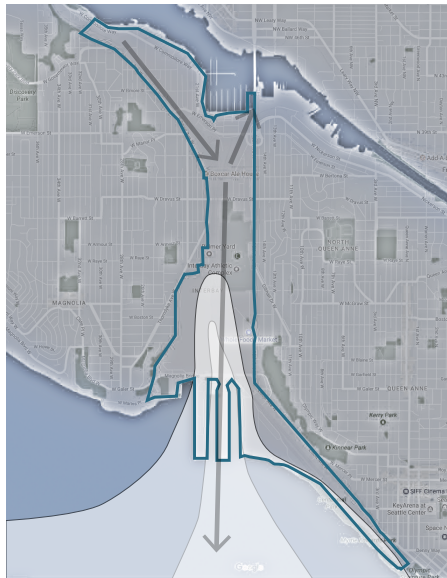

Figure 86. The site is prone to liquefaction because it was filled with dredged soil from the Fremont cut, and is also uncompacted glacial silt (Above).



Figure 87. The proposed DfD industry would move components over short distances, and thus wouldn't rely heavily on rail infrastructure or ports, which is central to its current use.

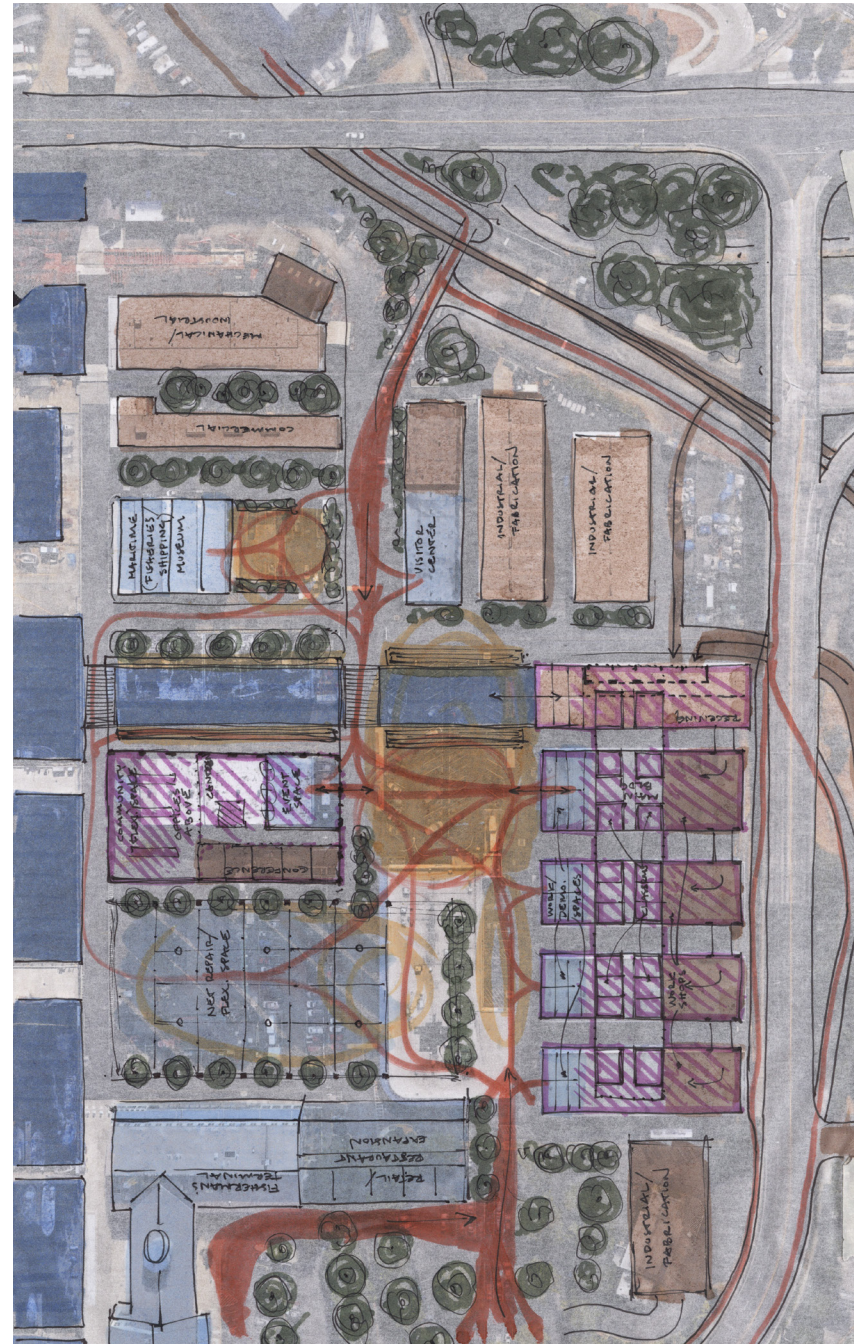

Figure 88. Interbay is dominated by large property owners. The Port of Seattle is the only one currently pursuing increased density and programmatic changes.



Figure 89. Interbay's new businesses cling to the periphery, and only a sweeping change in the district's ownership would allow for the development envisioned above.

Figure 90. Exploring opportunities to utilize the old net sheds as an adaptive reuse project, and build a new structure opposite them. This approach satisfied whole building reuse, and new construction, but did not address existing building stock - low value, program-specific architecture.



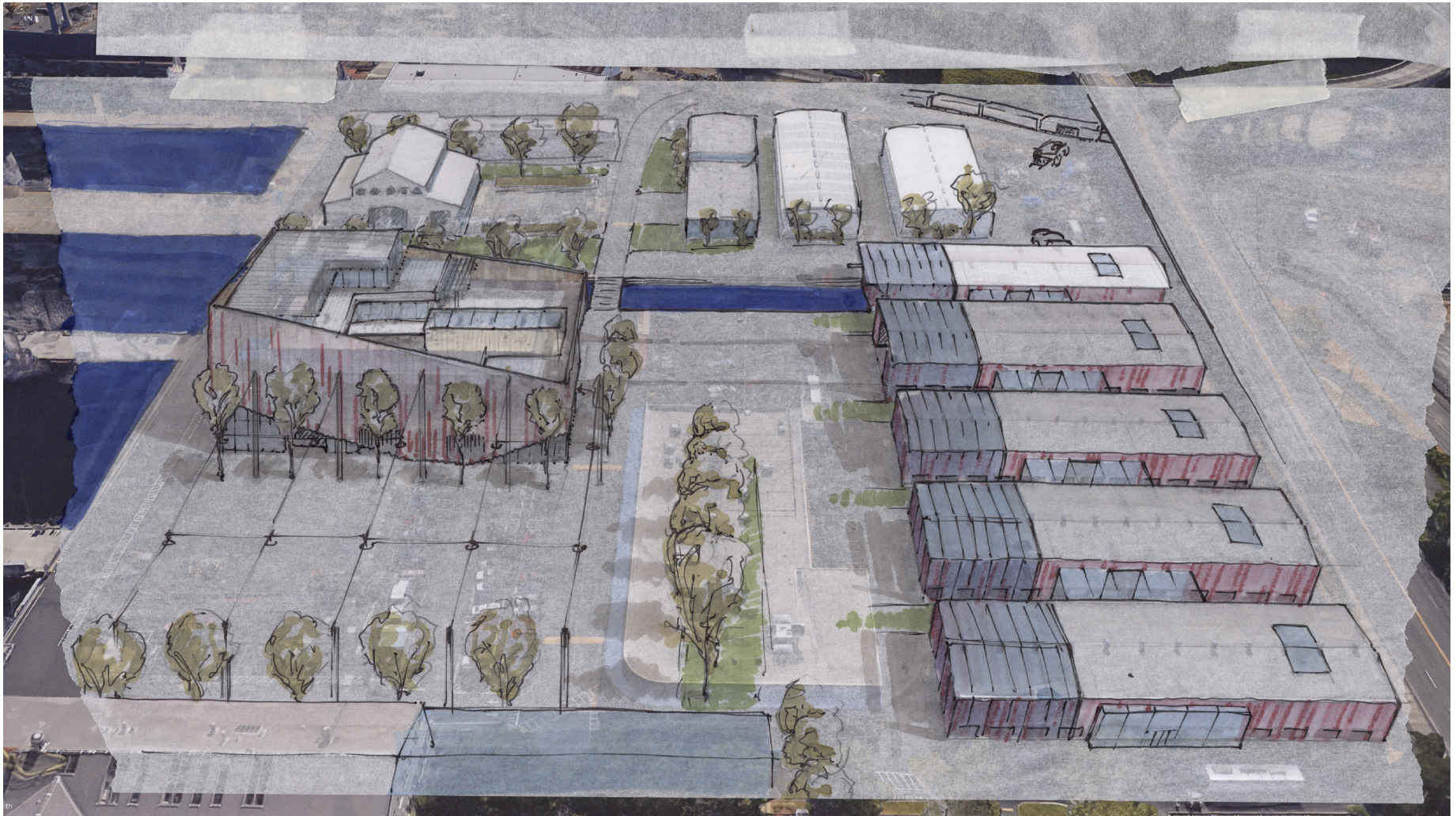

Figure 91. These studies conceived of F.T. as an opportunity for urban and landscape design, working with public space and building phases. The proposal was to consider the element of time as the most critical, foreshadowing the imminent sea level rise.

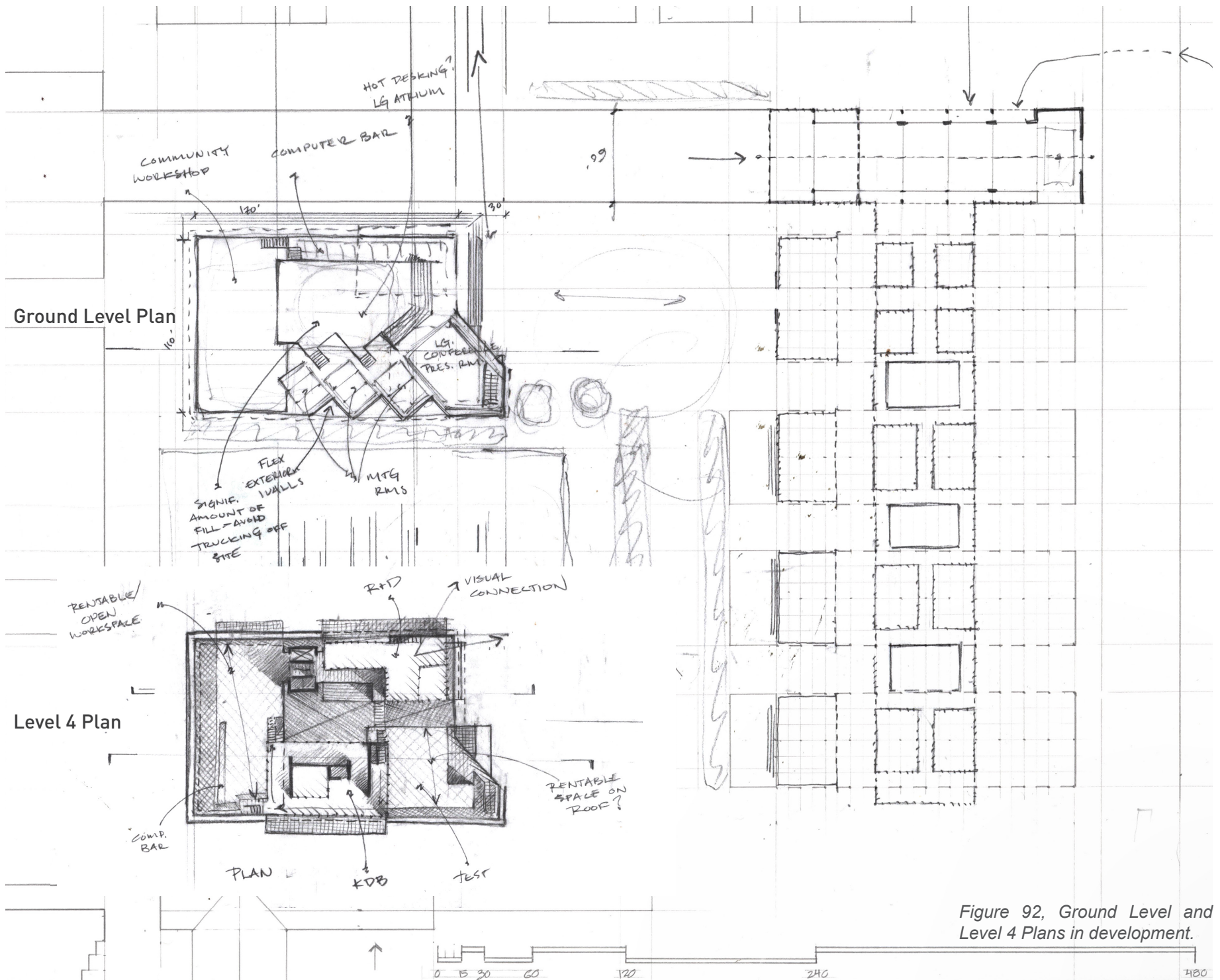
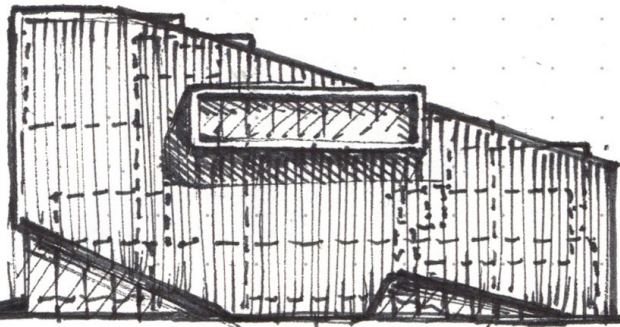
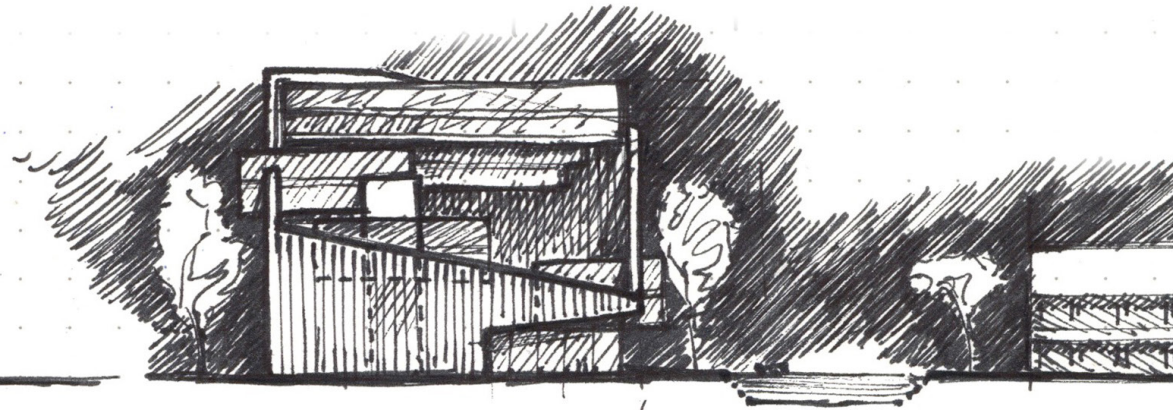

Figure 92, Ground Level and Level 4 Plans in development.



West Elevation



South Elevation

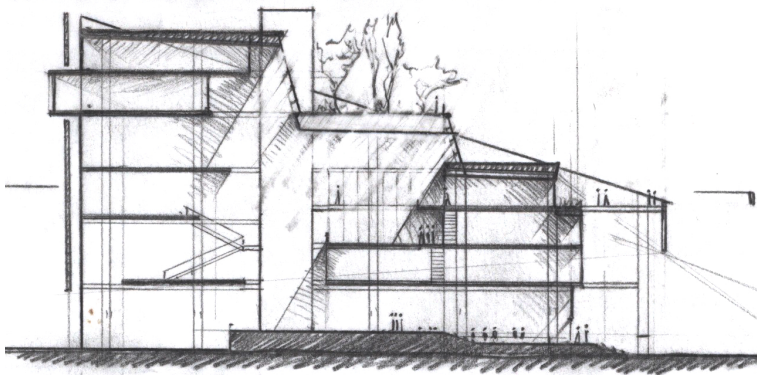

Section Facing East

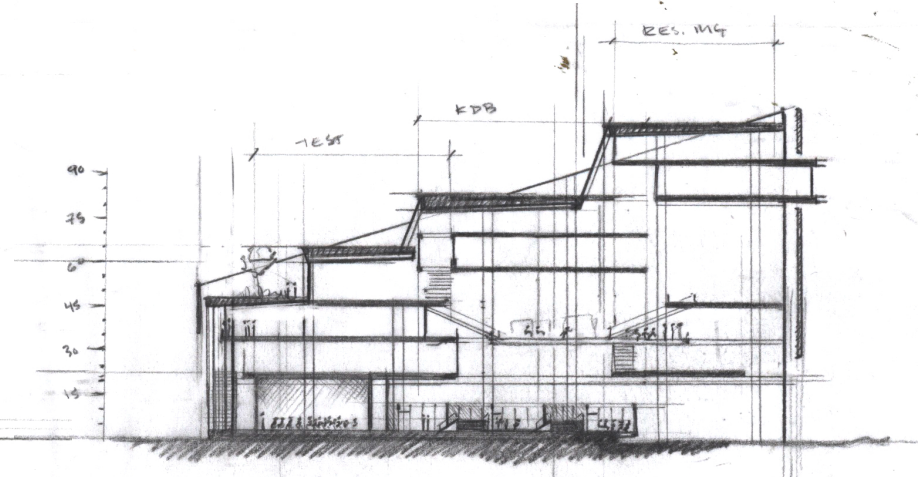

Section Facing West

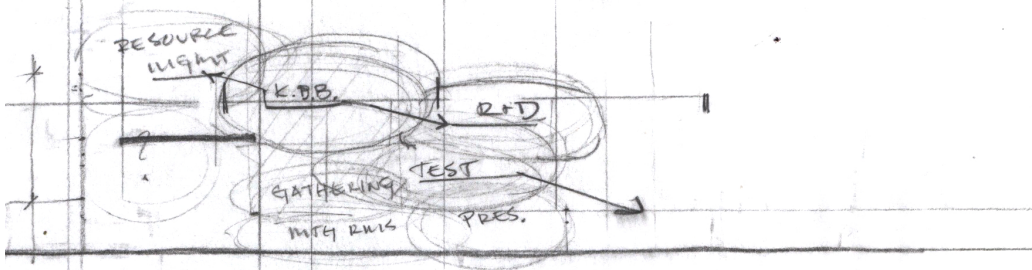

Diagrammatic Section

Figure 93. Early elevations of the building suggested a modular cladding system that wrapped the building - this would be a tool for illustrating the flexibility of a system, and would be replaced periodically. When the project turned toward timber reclamation, the facade changed, flipping the layering so the wood louvers would be internal, protecting them with a glazed skin.

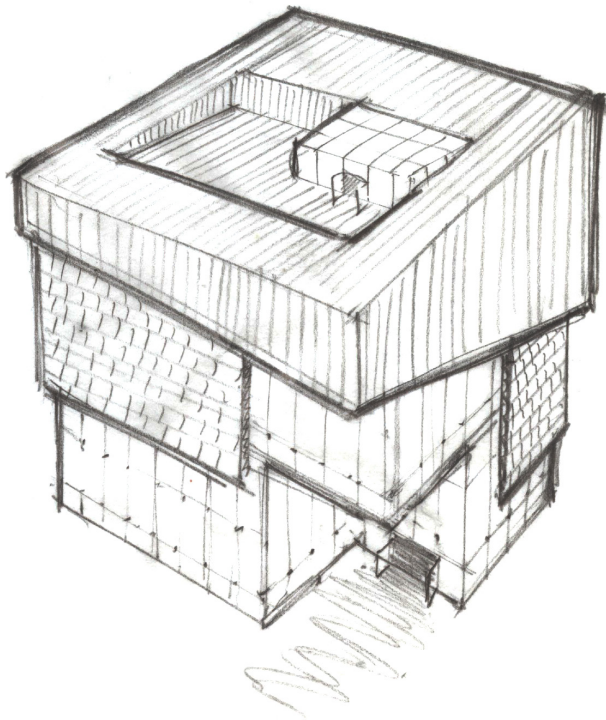

Figure 94, Layered building.

The thesis was an opportunity for exploring details at different scales. Many solutions were extremely complex, and fell into the “kit-of-parts” camp. Others revealed the layers of complexity inherent in achieving infinitely reusable or recyclable components. To reconfigure a building, we must think of our entire stock of building materials as the “kit,” and to keep each piece free of permanent fixation to the others. The perspective sketch (Left) is an idea about layering - the distinct material changes reveal how the building comes together. It is a diagram for separability, and can be achieved at every scale.

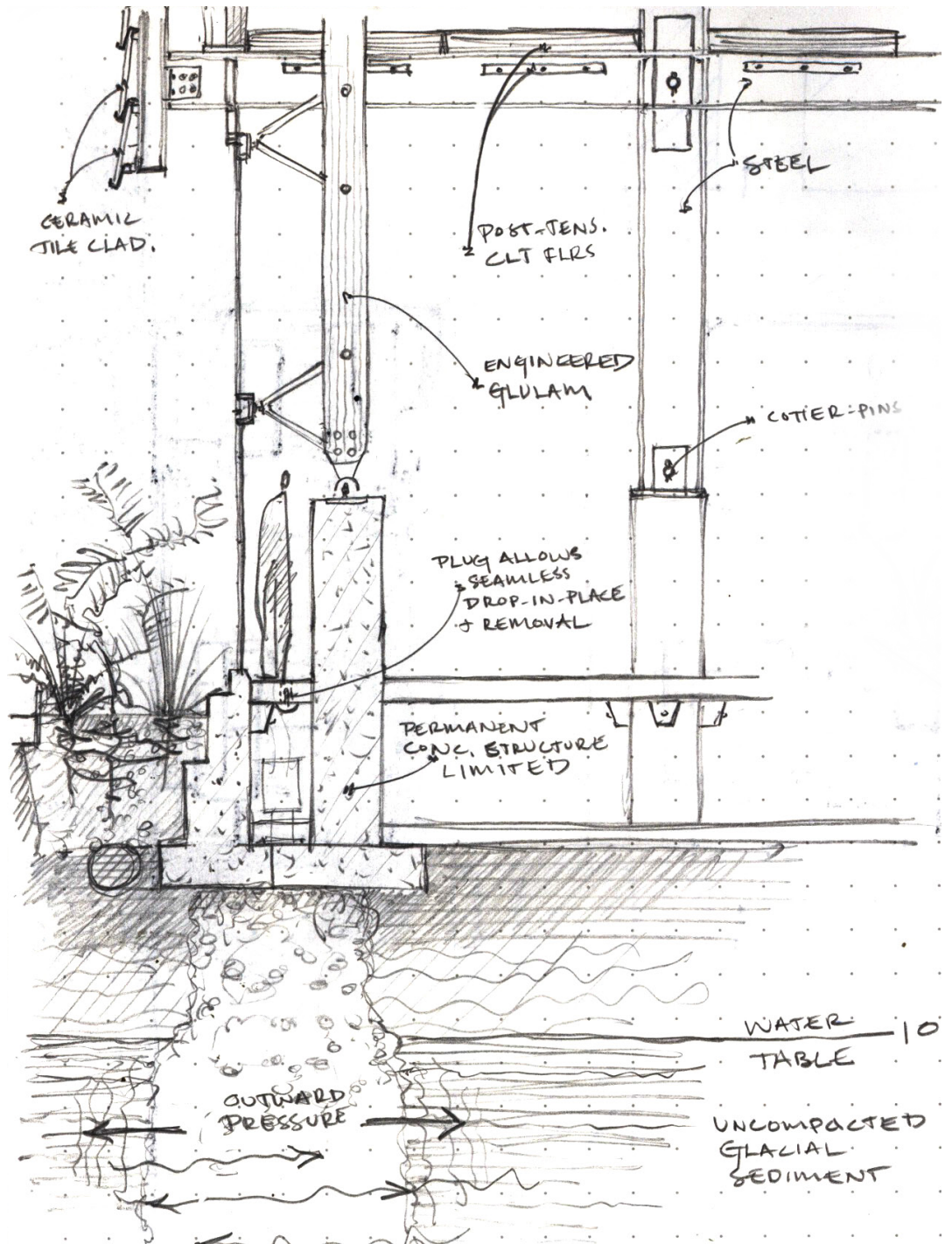

Figure 95, wall section in development.